

Door Lock Control <Except Korea>

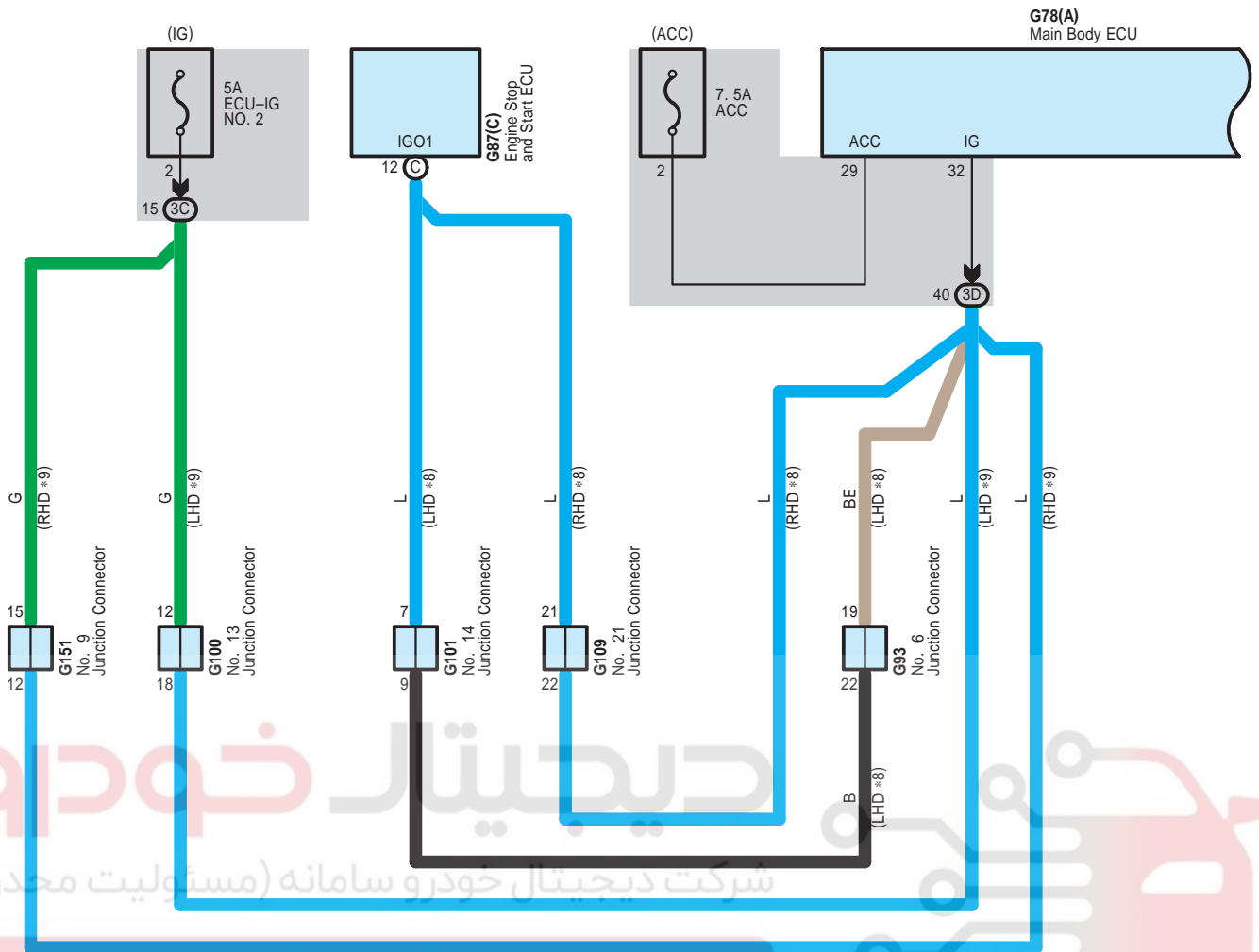

دیجیتال خودرو
 شرکت دیجیتال خودرو سامانه (مسئولیت محدود)
 اولین سامانه دیجیتال تعمیرکاران خودرو در ایران

- * 8 : w/ Stop & Start System
- * 9 : w/o Stop & Start System
- *29 : w/ Double Locking
- *30 : w/o Double Locking
- *37 : w/ Entry & Start System

Door Lock Control <Korea>

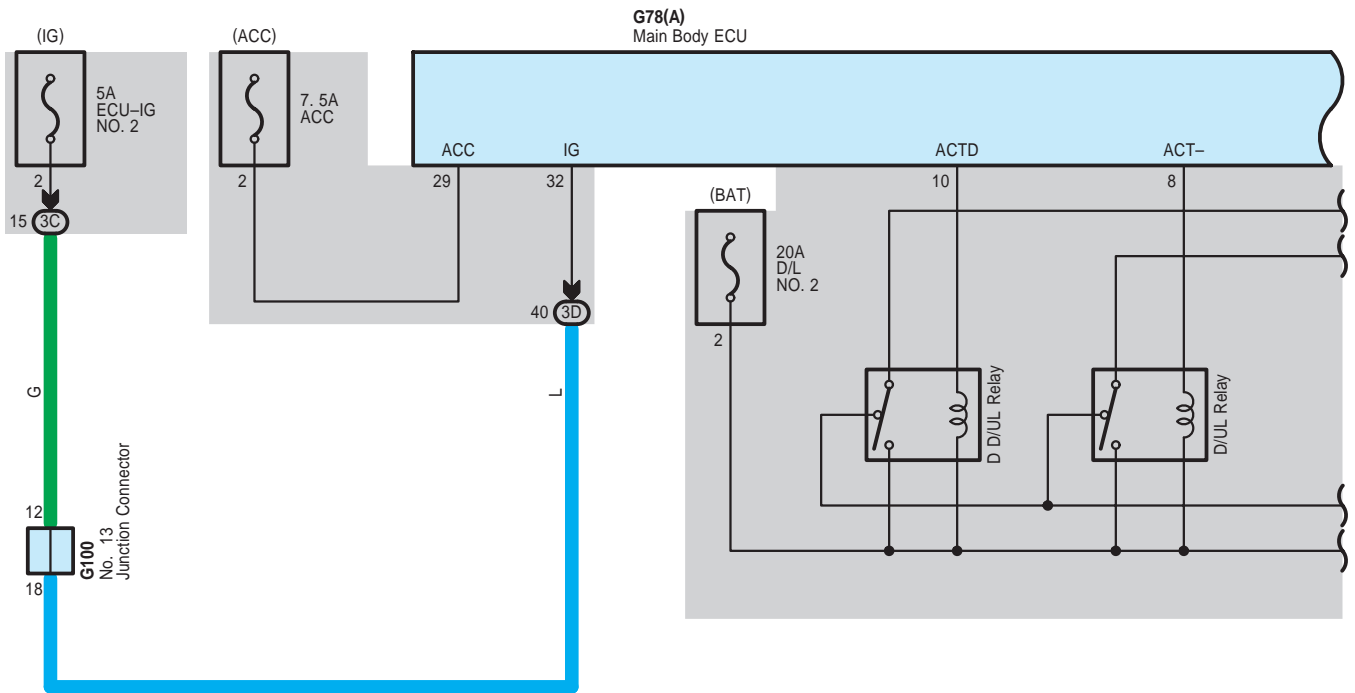

دیجیتال خودرو

شرکت دیجیتال خودرو سامانه (مسئولیت محدود)

اولین سامانه دیجیتال تعمیرکاران خودرو در ایران



Door Lock Control <Korea>

G78(A)
Main Body ECU

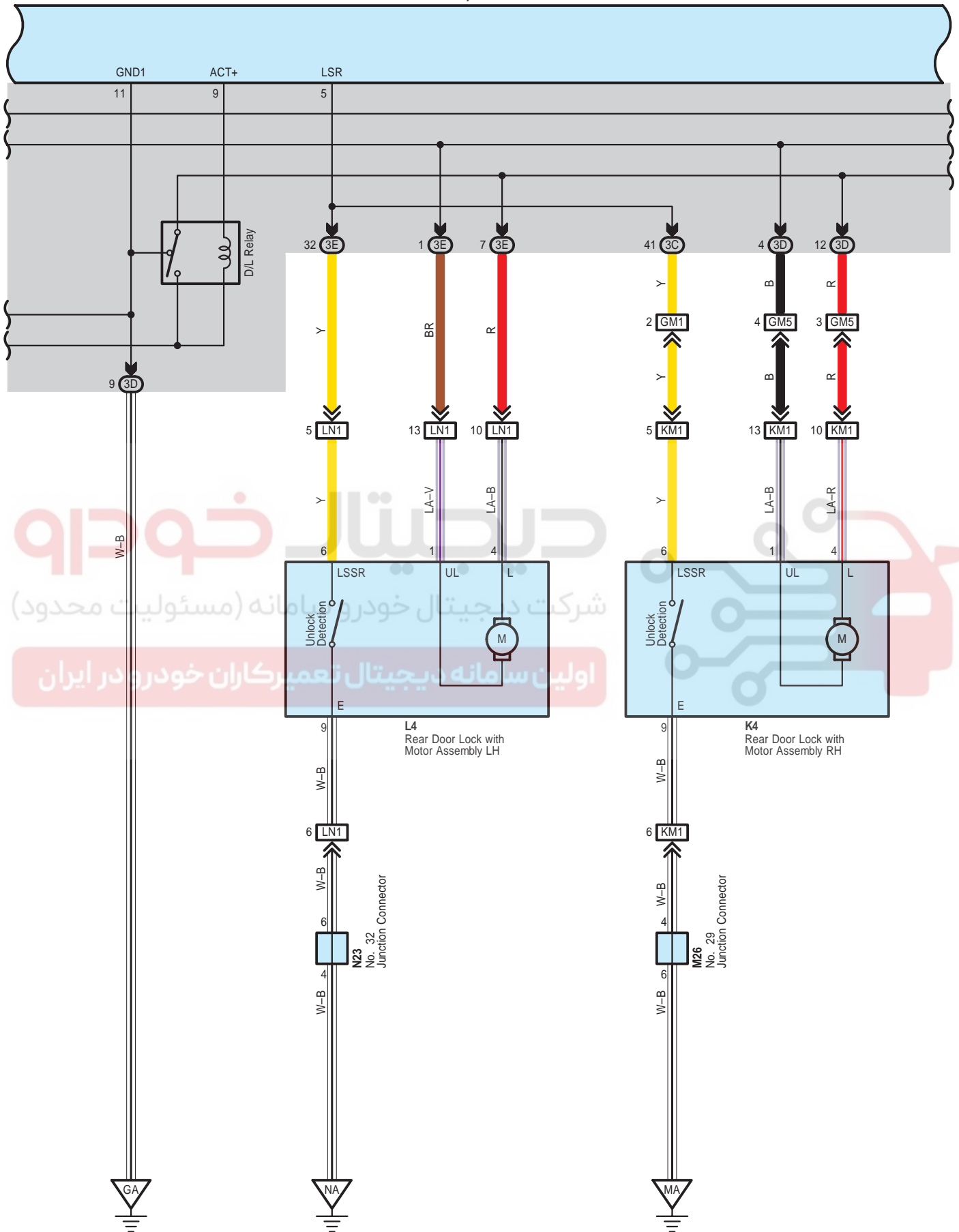

Door Lock Control <Korea>

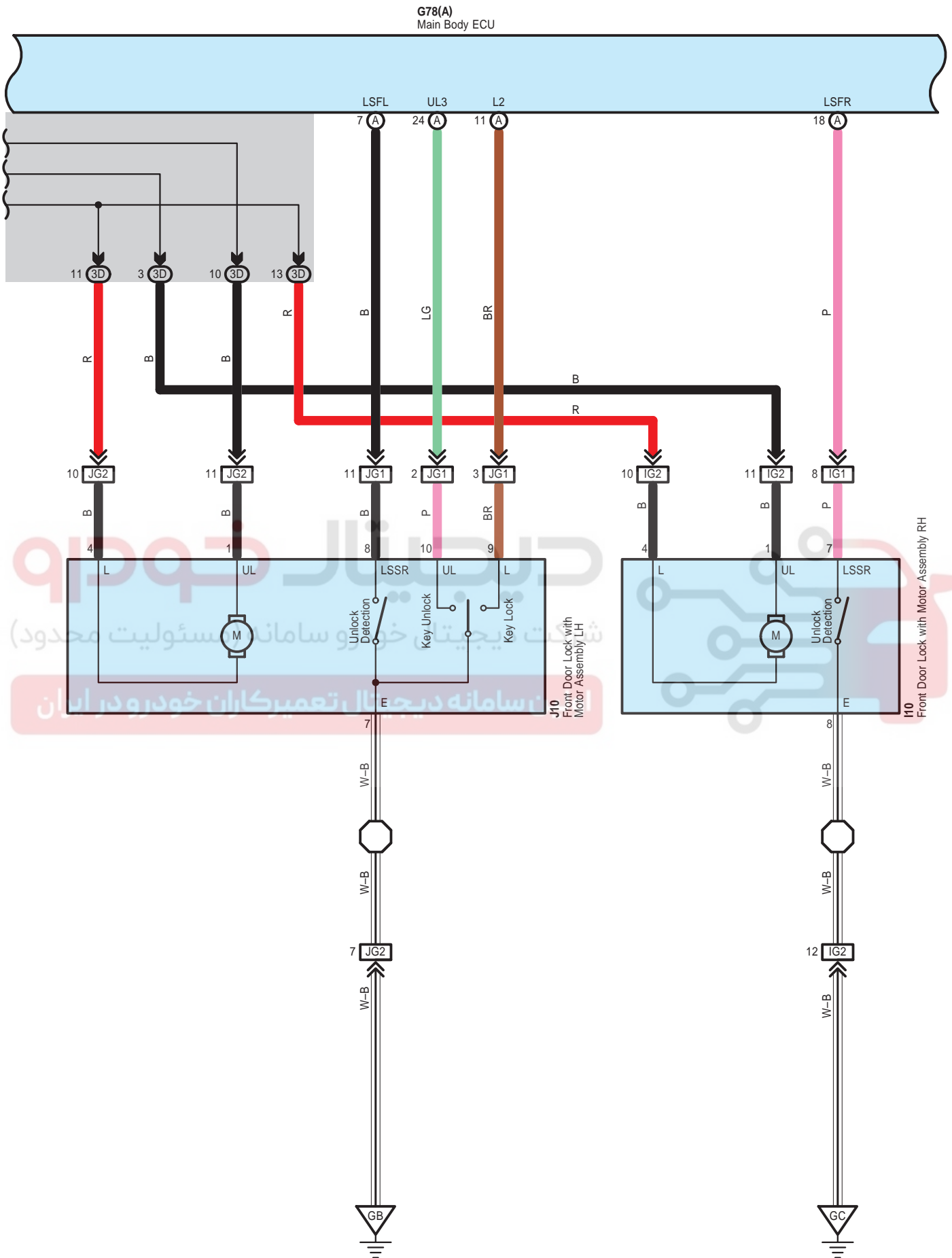

Door Lock Control <Korea>

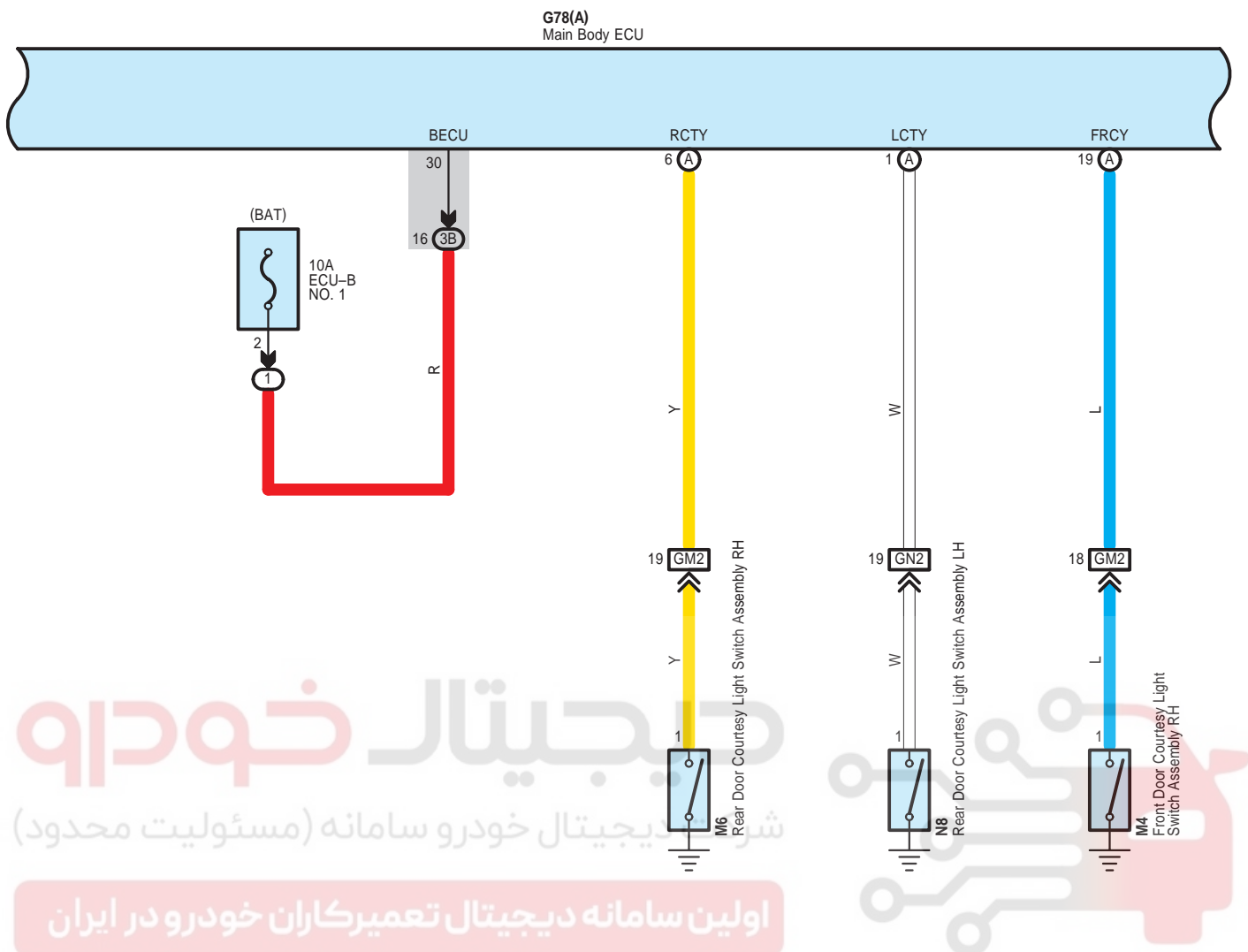

Door Lock Control <Korea>

G78(A)
Main Body ECU

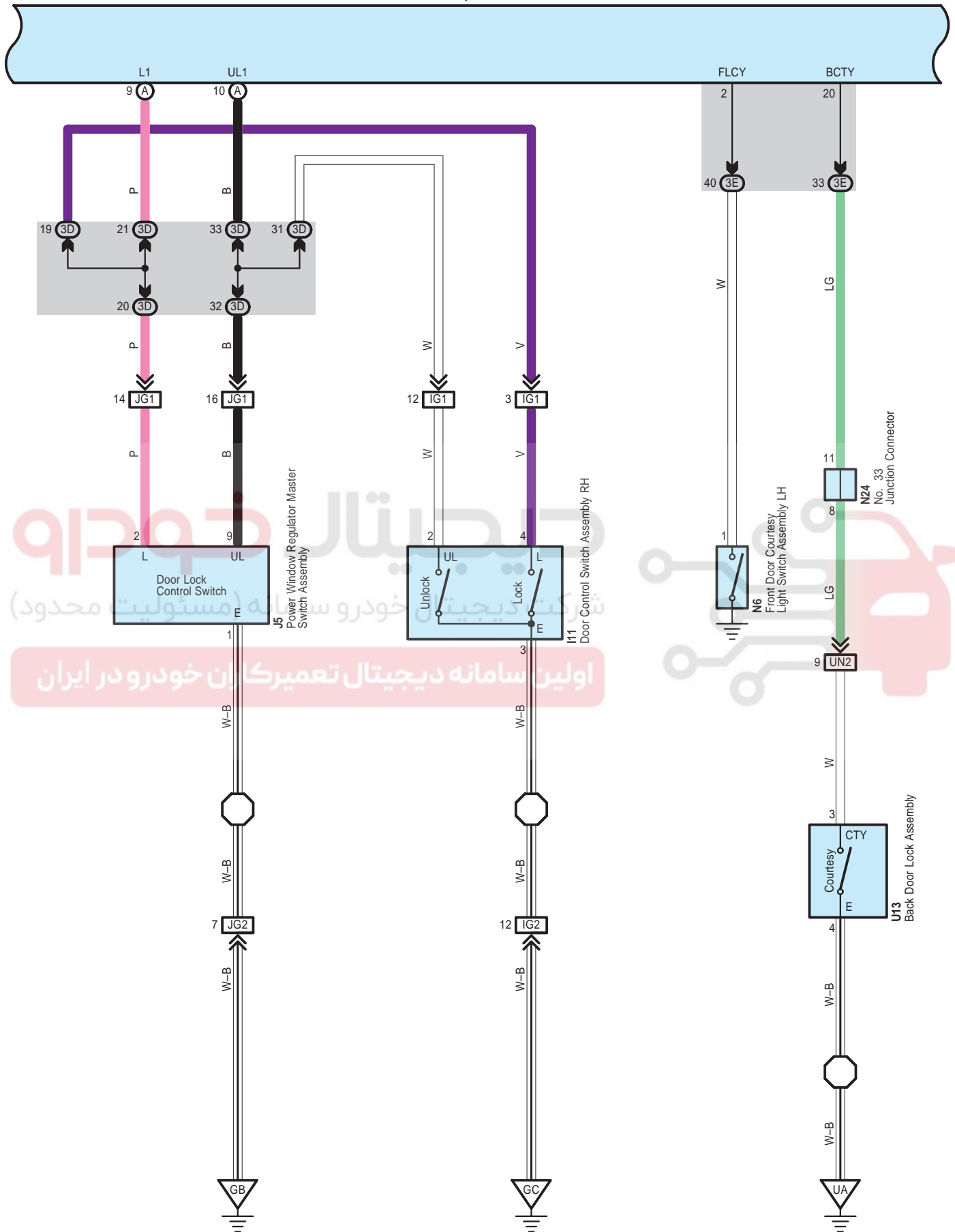

Door Lock Control <Korea>

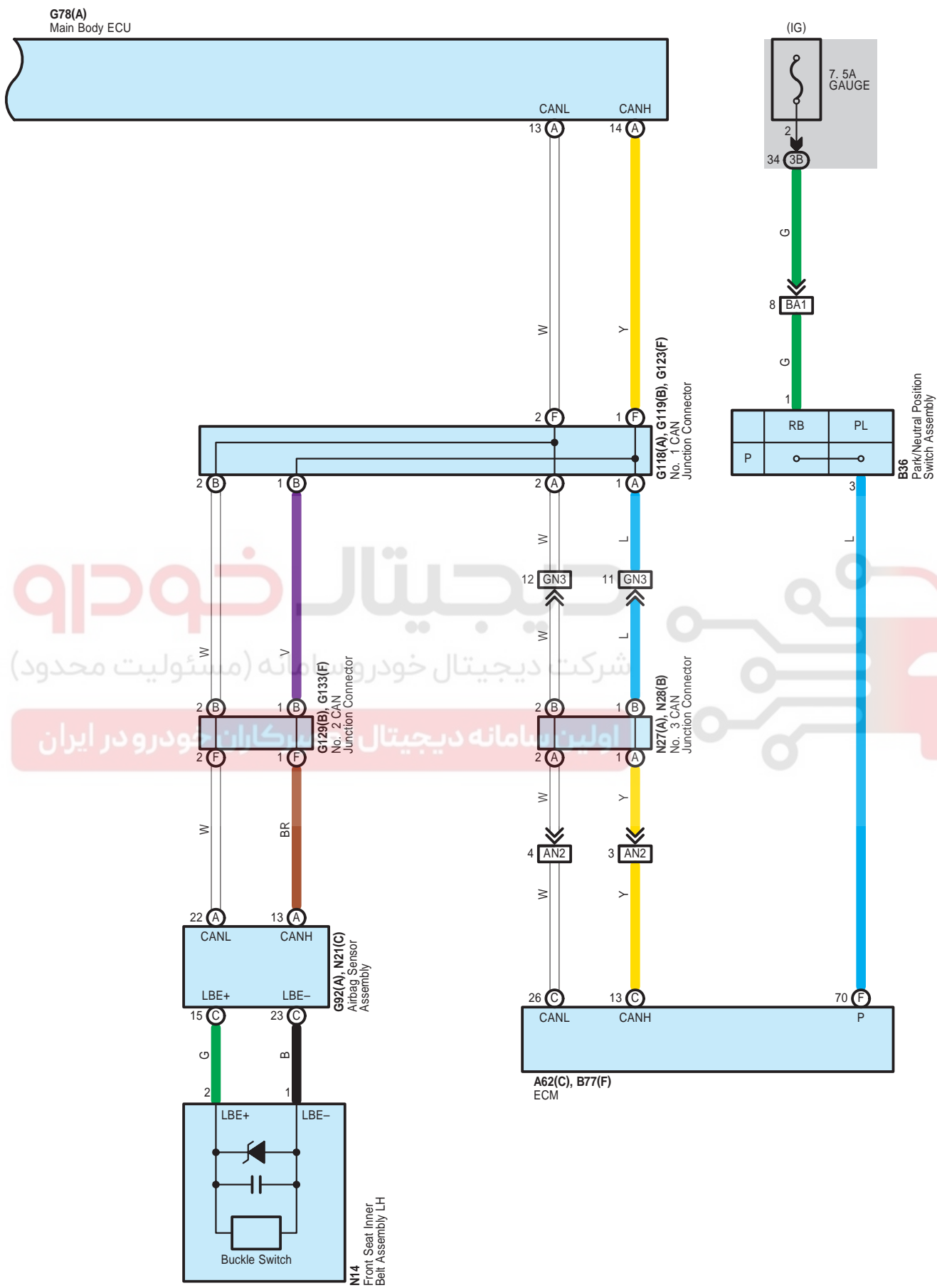

Door Lock Control <Korea>

A 62
Black

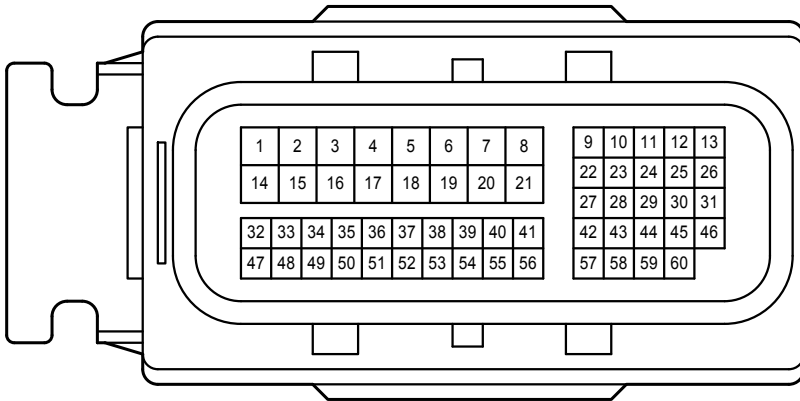

B 36
Gray

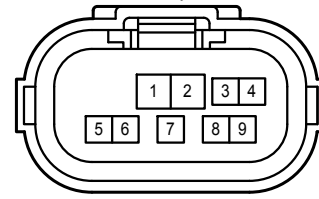

B 77
Black

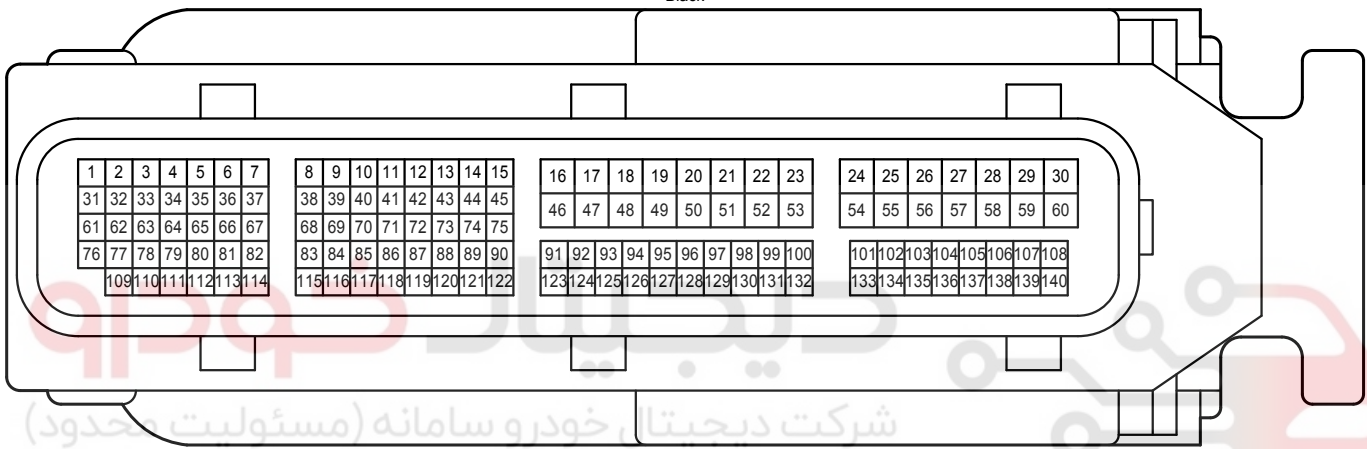

G 78
White

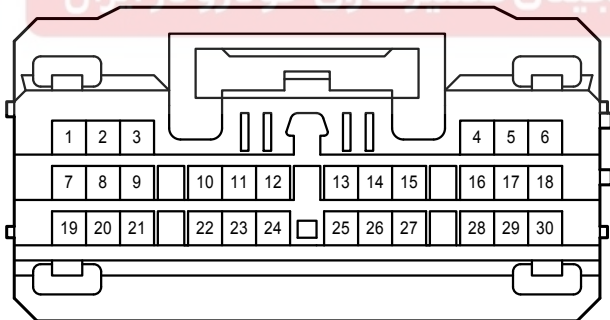

G 92
Yellow

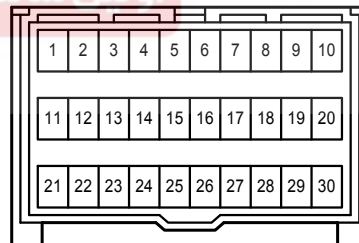

G100
Gray

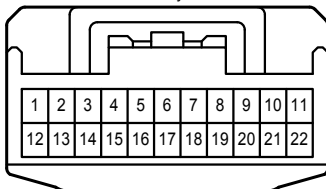

G118
White

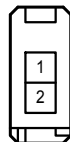

G119
White

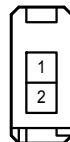

G123
White

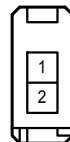

G129
White

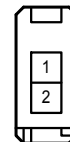

G133
White

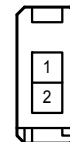

Door Lock Control <Korea>

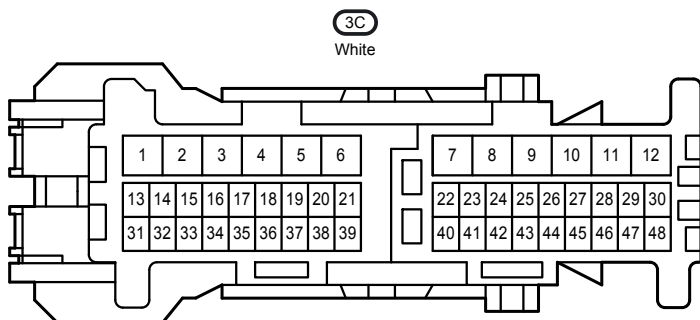
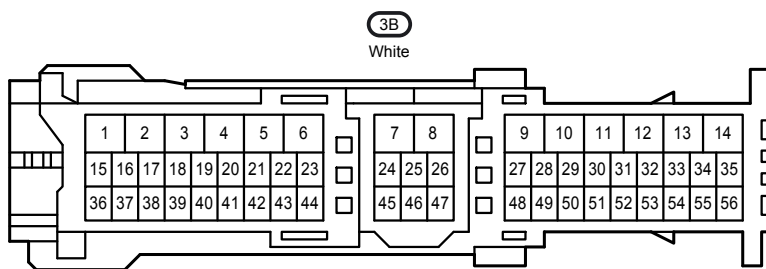
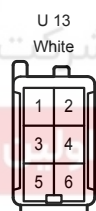
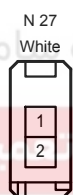
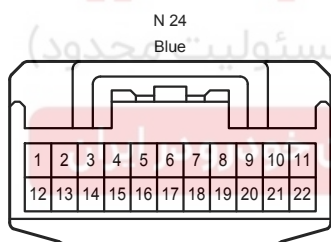
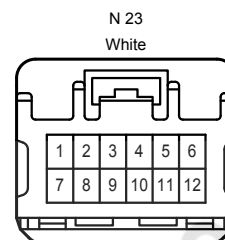
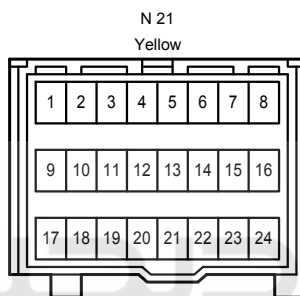
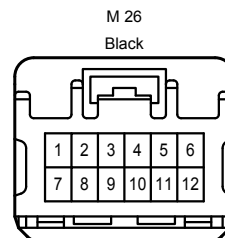
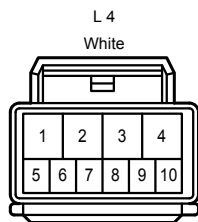
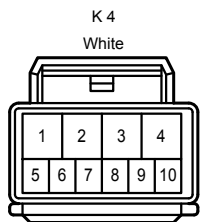
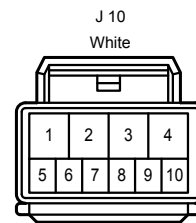
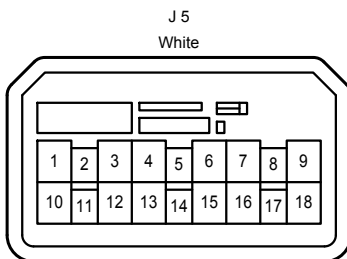
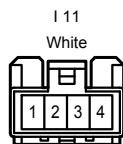
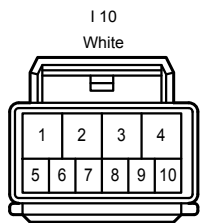

Door Lock Control <Korea>

3D
White

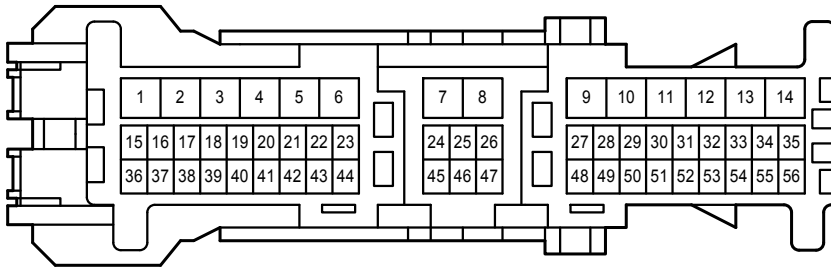

3E
White

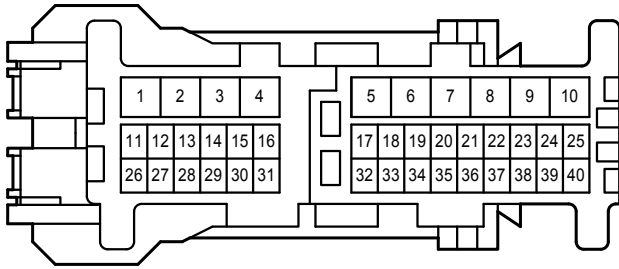

AN2
White

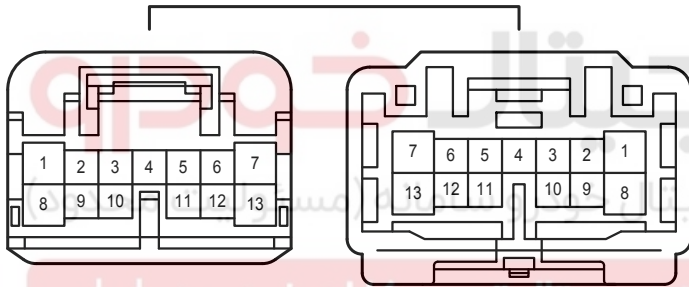

BA1
Blue

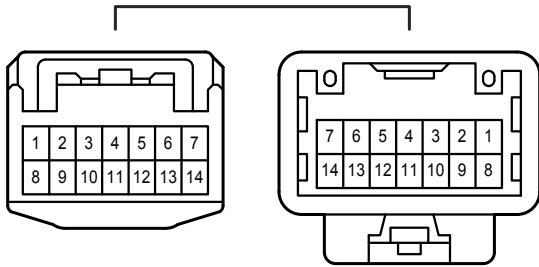

GM1
White

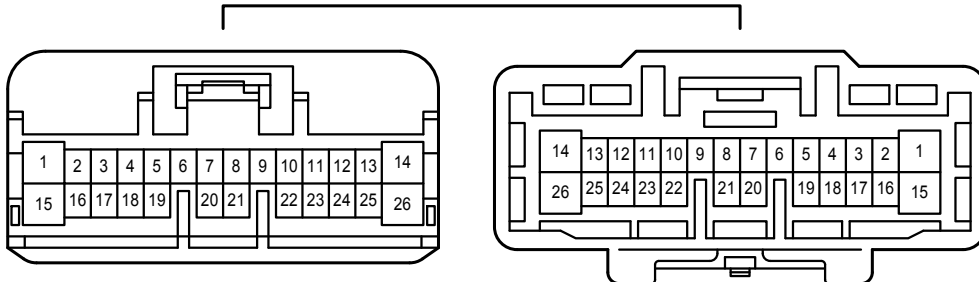

اولین سامانه دیجیتال تعمیرکاران خودرو در ایران

Door Lock Control <Korea>

GM2
Blue

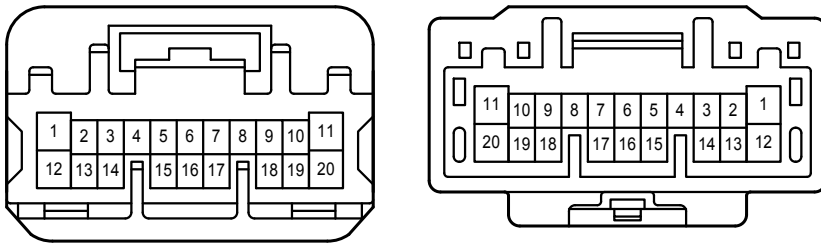

GM5
White

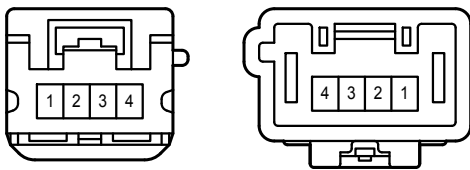

GN2
Blue

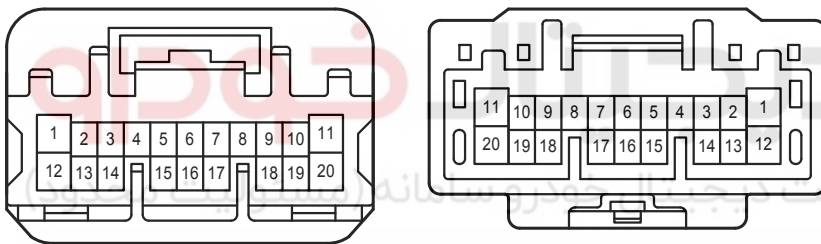

GN3
White

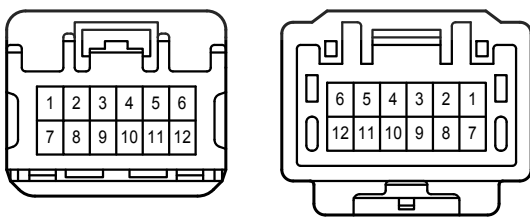

IG1
White

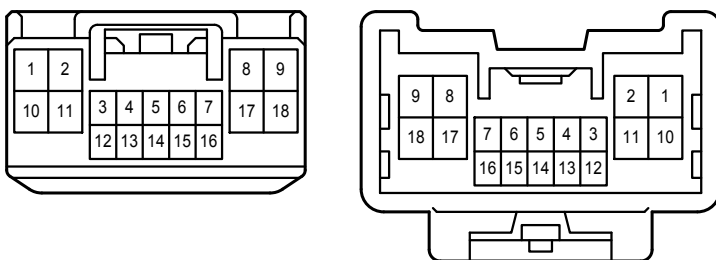

اولین سامانه دیجیتال تعمیرکاران خودرو در ایران

Door Lock Control <Korea>

IG2
White

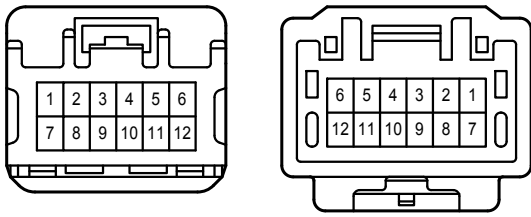

JG1
White

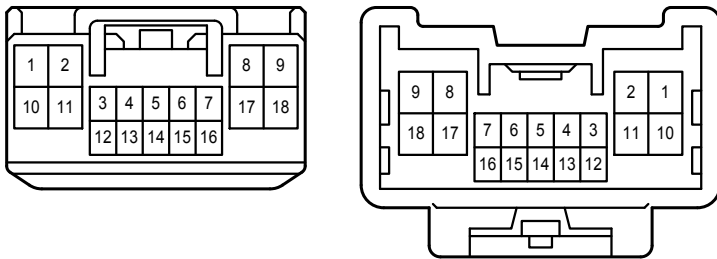

JG2
White

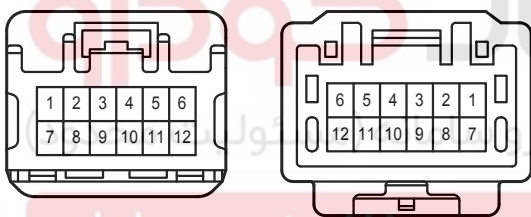

KM1
White

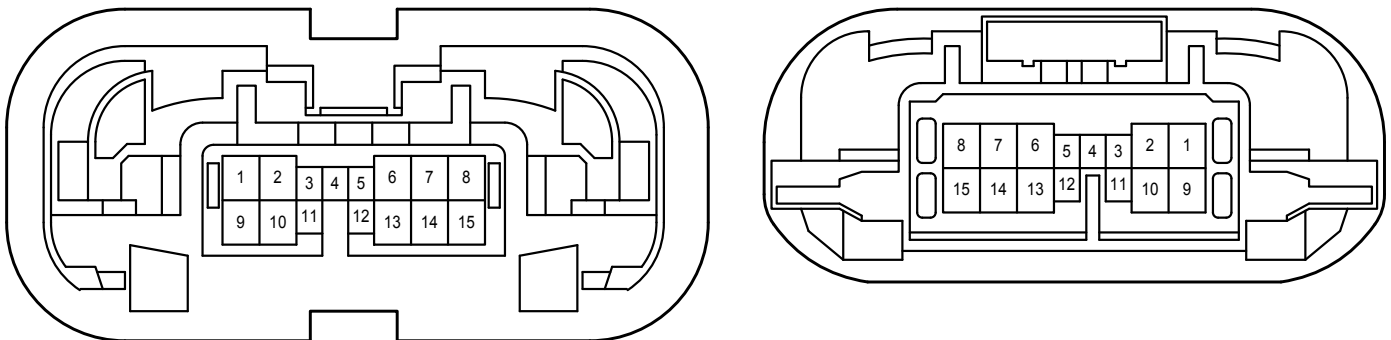

Door Lock Control <Korea>

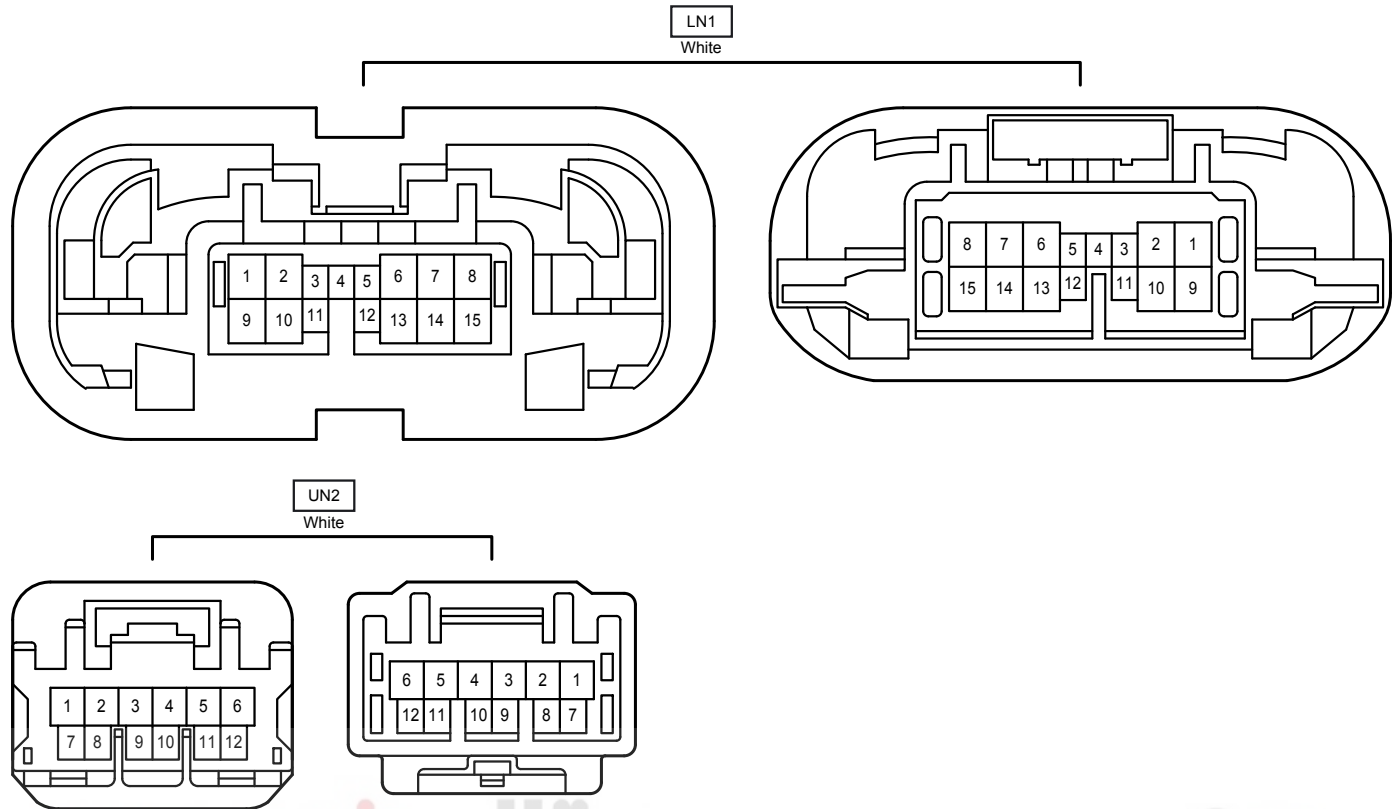

دیجیتال خودرو

شرکت دیجیتال خودرو سامانه (مسئولیت محدود)

اولین سامانه دیجیتال تعمیرکاران خودرو در ایران



Door Lock Control <Except Korea>

G78(A)
Main Body ECU

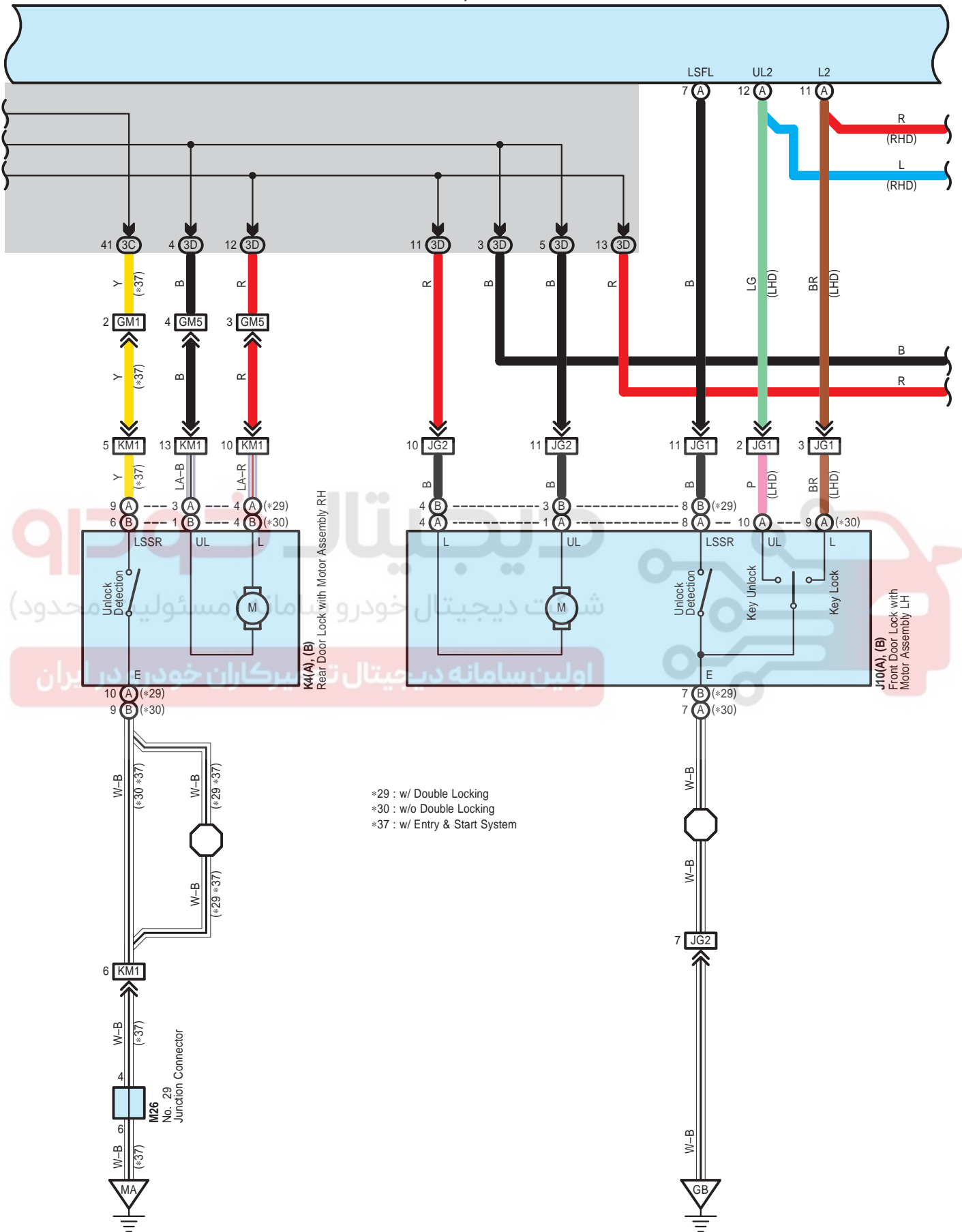

*29 : w/ Double Locking
 *30 : w/o Double Locking
 *37 : w/ Entry & Start System

Door Lock Control <Except Korea>

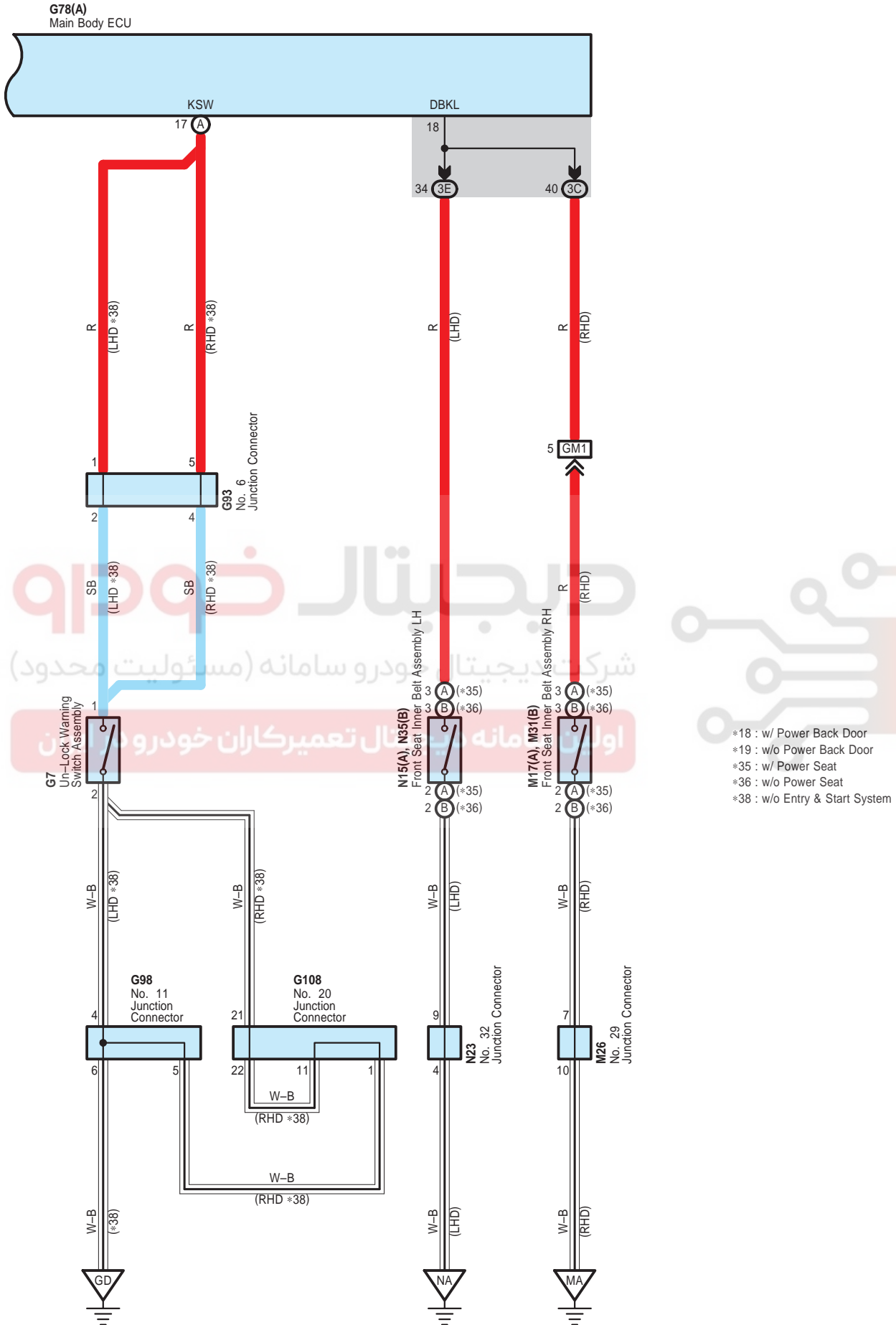

- *18 : w/ Power Back Door
- *19 : w/o Power Back Door
- *35 : w/ Power Seat
- *36 : w/o Power Seat
- *38 : w/o Entry & Start System

Door Lock Control <Except Korea>

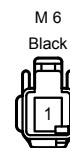
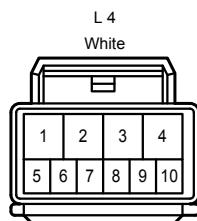
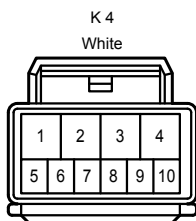
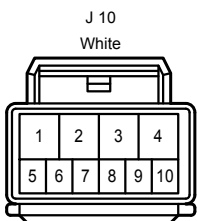
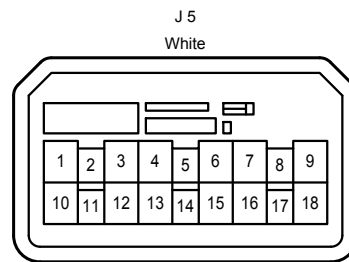
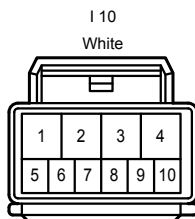
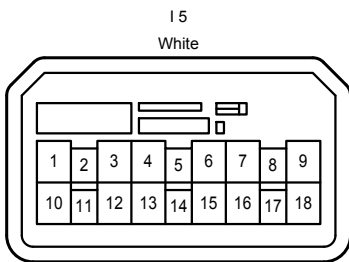
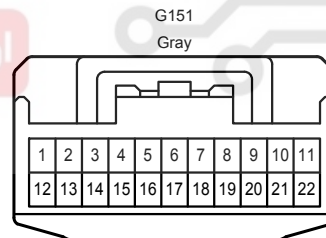
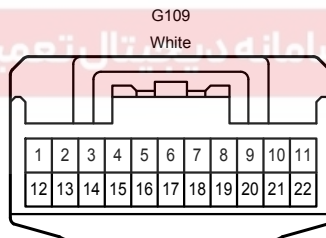
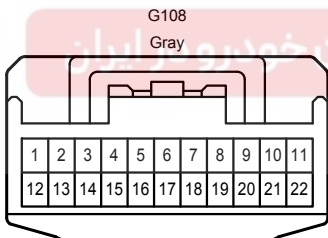
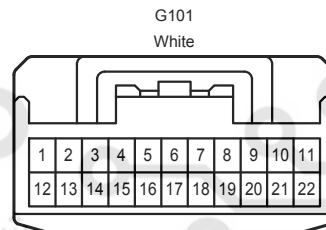
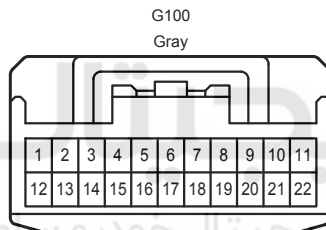
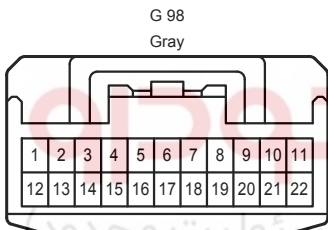
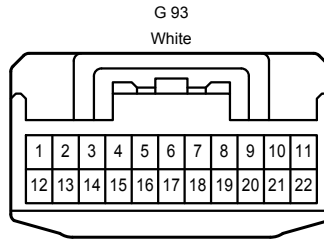
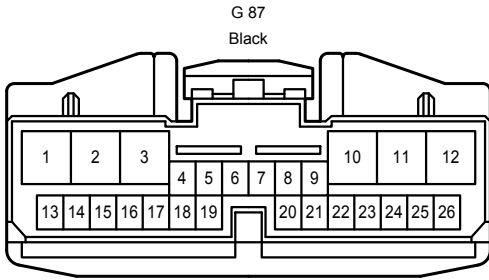
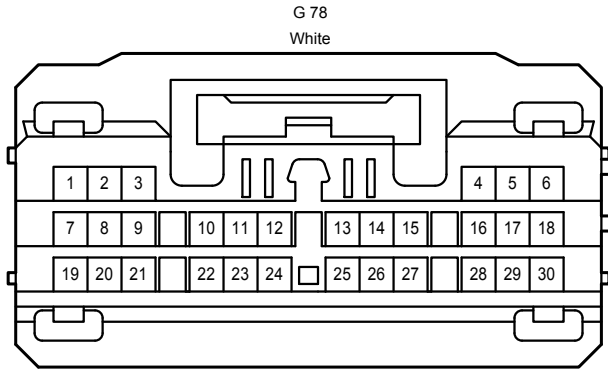
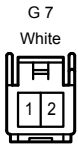

Door Lock Control <Except Korea>

M 17
White

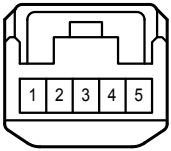

M 26
Black

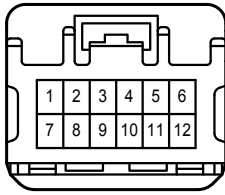

M 31
White

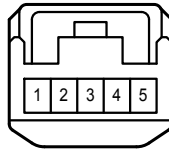

N 6
Black



N 8
Black



N 15
White

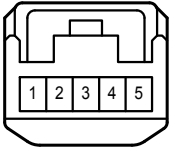

N 23
White

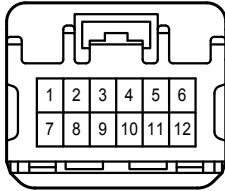

N 24
Blue

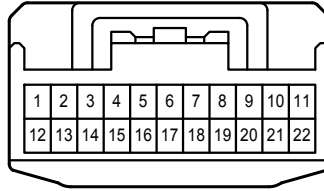

N 35
White

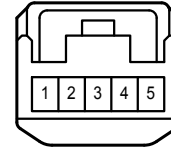

U 12
Black

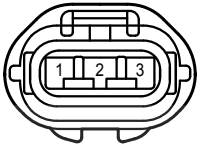

U 13
White

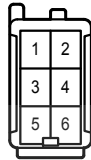

3B
White

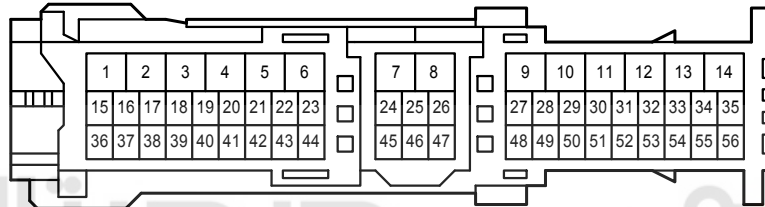

3C
White

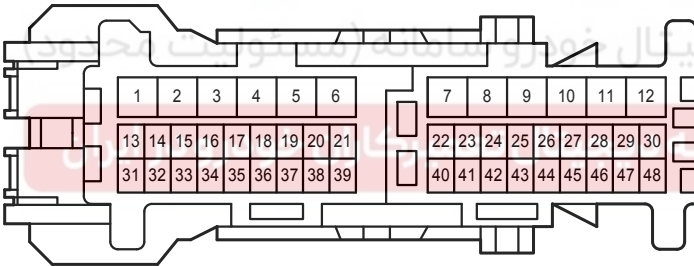

3D
White

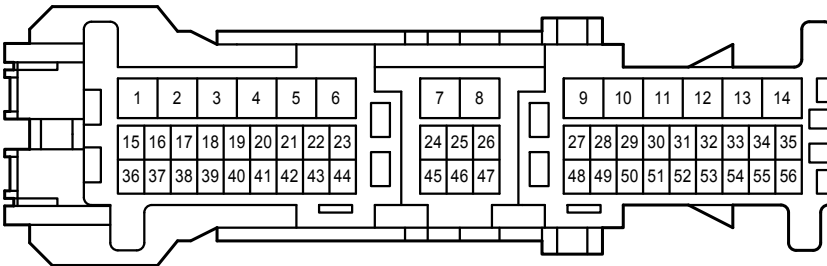

Door Lock Control <Except Korea>

3E
White

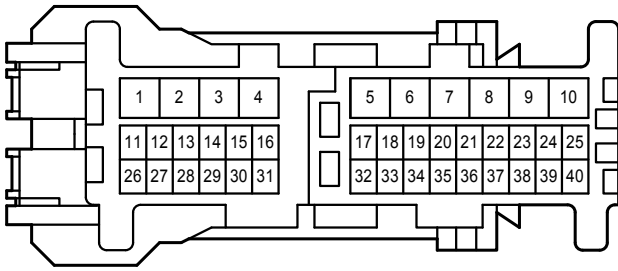

GM1
White

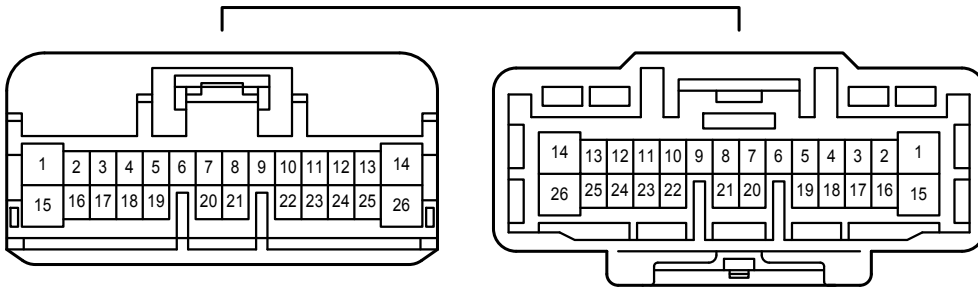

GM2
Blue

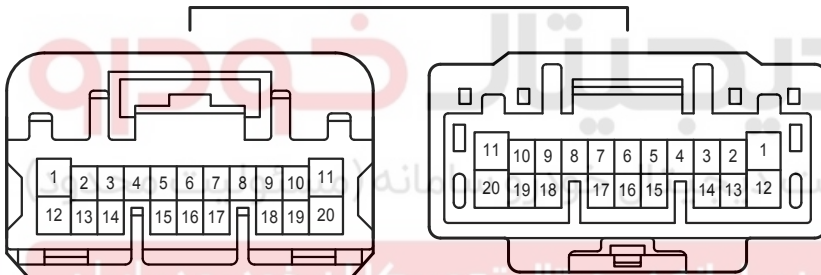

GM5
White

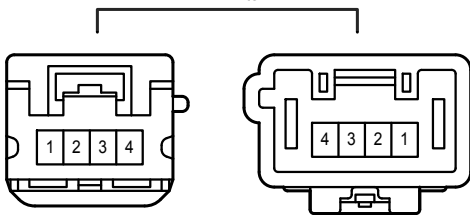

GN2
Blue

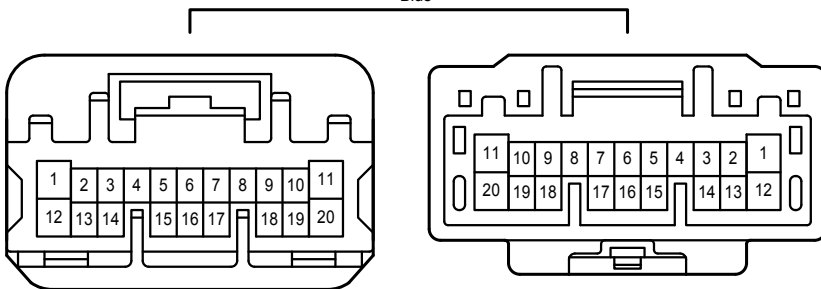

Door Lock Control <Except Korea>

IG1
White

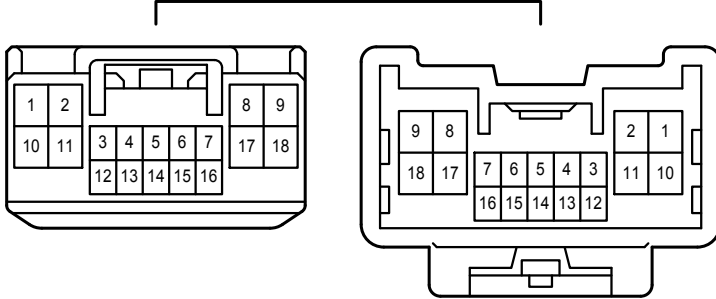

IG2
White

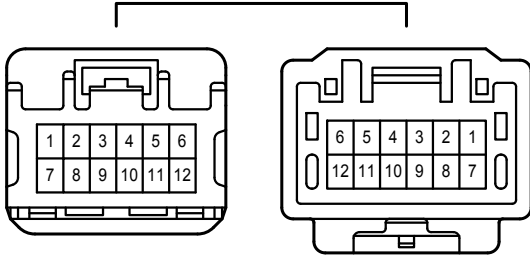

JG1
White

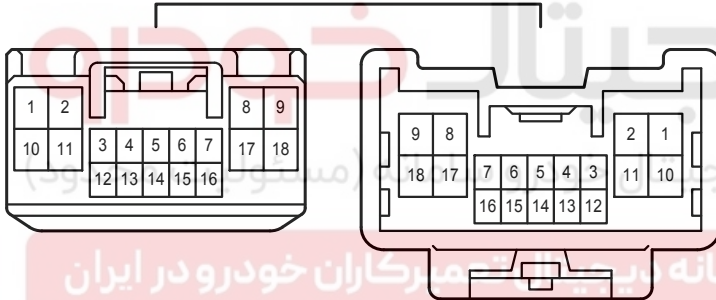

JG2
White

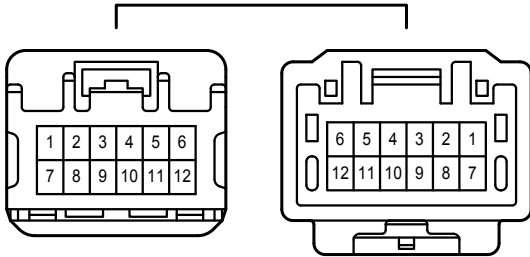

Door Lock Control <Except Korea>

KM1
White

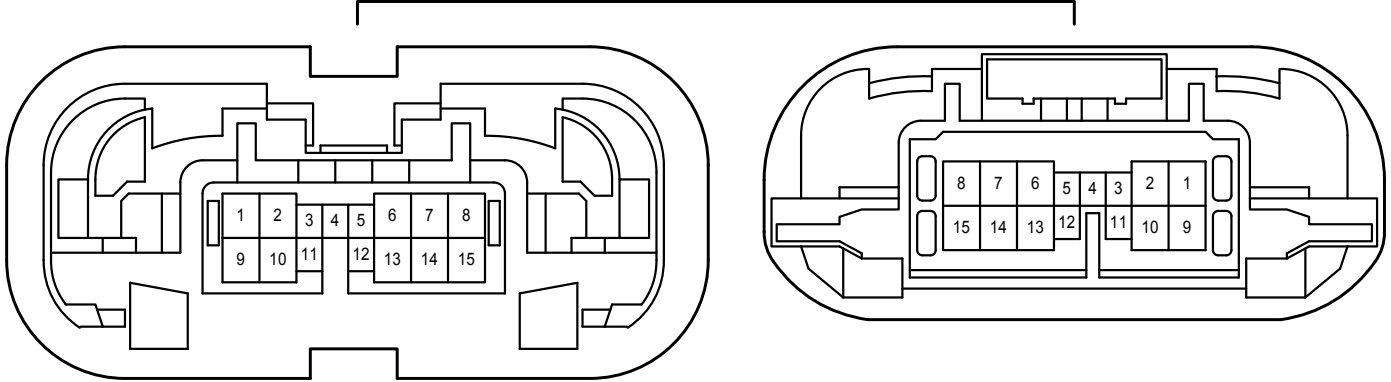

LN1
White

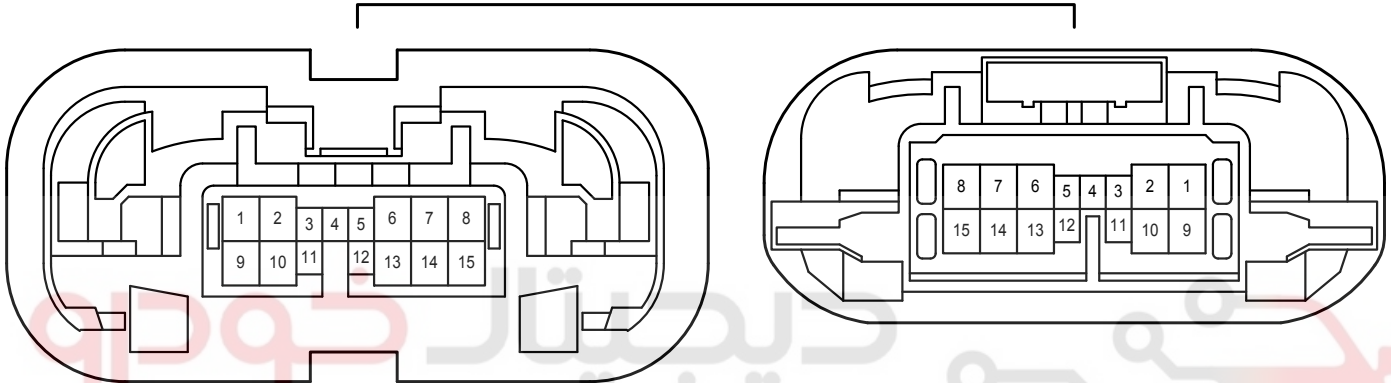

UN2
White

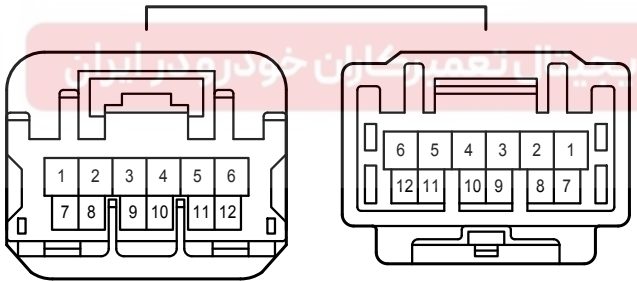

شرکت دیجیتال خودرو سامانه (تولیت محدود)
اولین سامانه دیجیتال تعمیرکاران خودرو در ایران