

Reversing Lamp

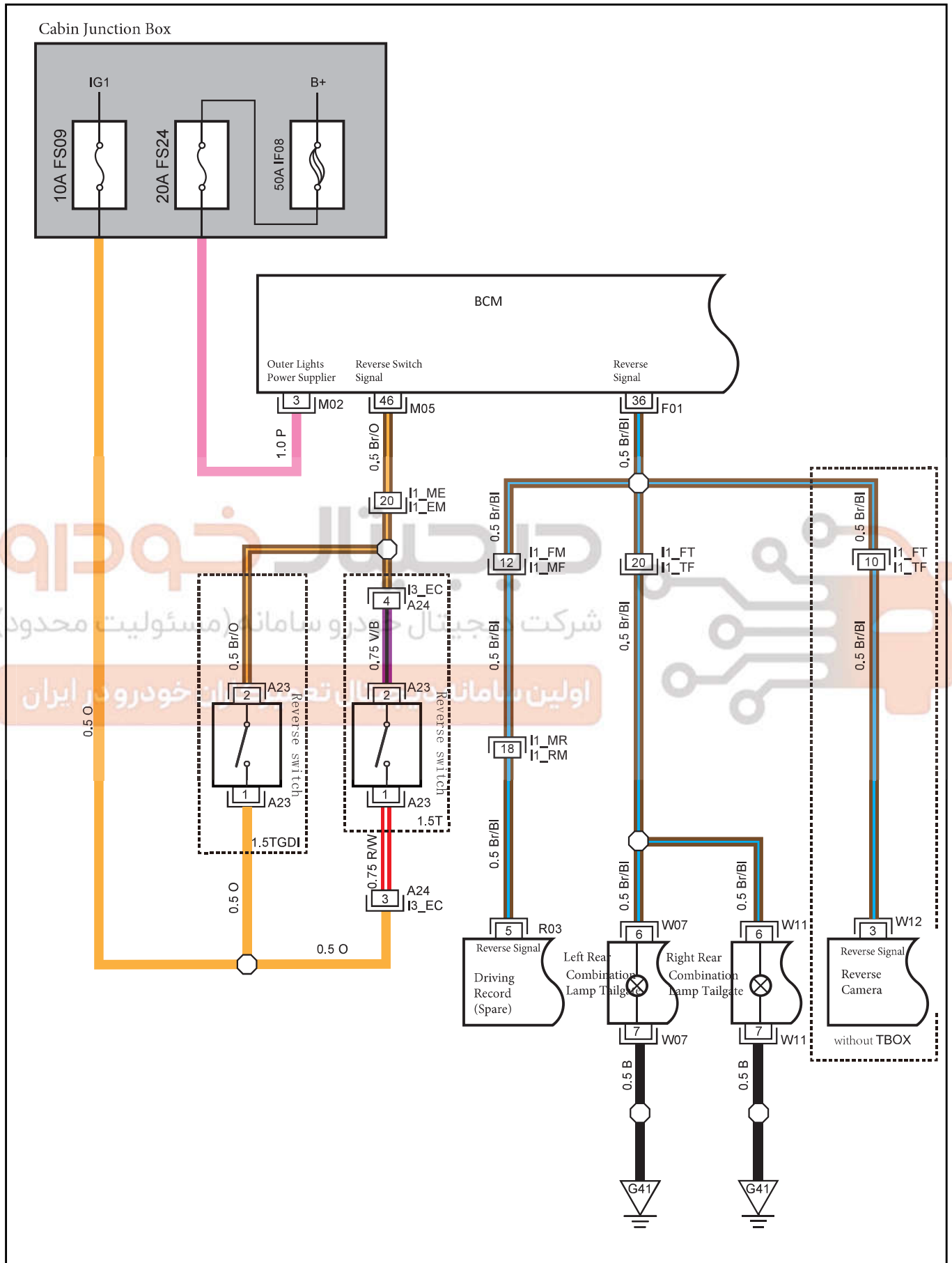

Harness Connector	Name	Page
A23	Reversing Light Switch	18
F01	BCM C2	25
F14	Right Rear Outer Combination Light	25
F19	Left Rear Outer Combination Light	26
I1_EM	Engine Harness to Main Harness 1	16
I1_FM	Body Harness to Main Harness 1	25
I1_FT	Body Harness to Tailgate Transition Harness	26
I1_ME	Main Harness to Engine Harness 1	20
I1_MF	Main Harness to Body Harness 1	20
I1_TF	Tailgate Transition Harness to Body Harness	34
I1_TW	Tailgate Transition Harness to Tailgate Harness	34
I1_WT	Tailgate Harness to Tailgate Transition Harness	34
I1_MR	Main Harness to Roof Harness	21
I1_RM	Roof Harness to Main Harness 1	23
I3_EC	Engine Harness to Control Harness; QNUtu	16
M02	BCM c 3	21
M05	BCM C1	20
W12	Reversing Camera	34
G05	Body Harness Left Rear GND 2	44
G09	Body Harness Right Rear GND 2	44

اولین سامانه دیجیتال تعمیرکاران خودرو در ایران

A23 Reversing Light Switch

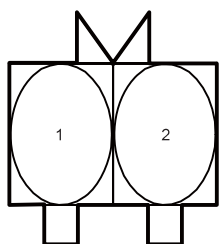

W12 Reversing Camera

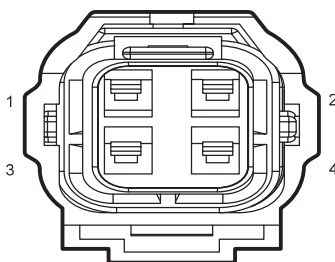

F01 BCM C2

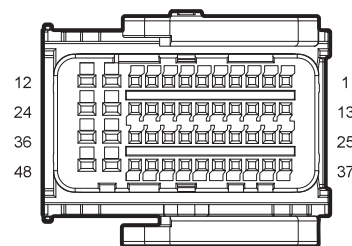

11_TF tail door transition line connects body line

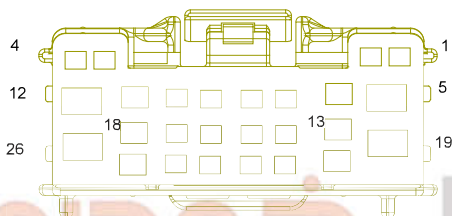

11 -- FT body line is connected with tail door transition line

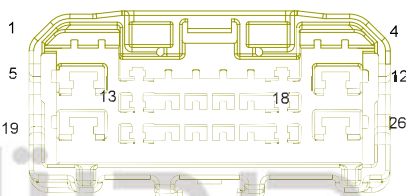

G05 Body Harness Left Rear GND 2

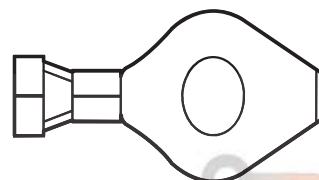

G09 Body Harness Right Rear GND 2

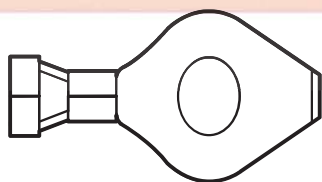

W011 left rear inside combination lamp

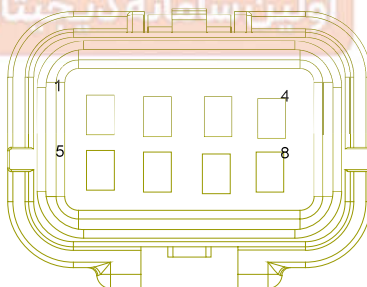

I1_FM Body Harness to Main Harness 1

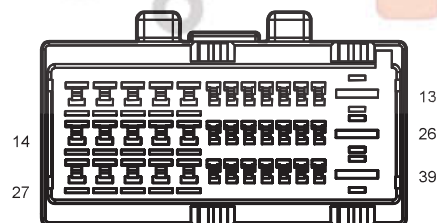

W07 left rear inside combination lamp

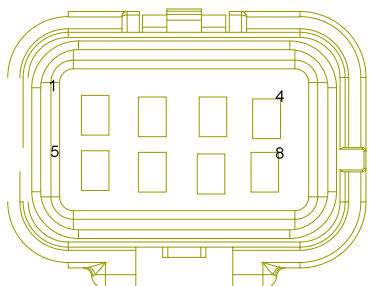

I1_MF Main Harness to Body Harness 1

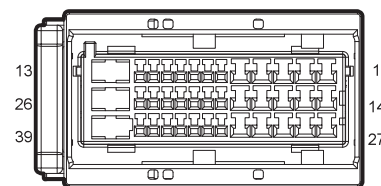

دیجیتال خودرو
شرکت دیجیتال خودرو سامانه (مسئولیت محدود)
اولین سامانه دیجیتال تعمیرکاران خودرو در ایران

I1_RM Roof Harness to Main Harness 1

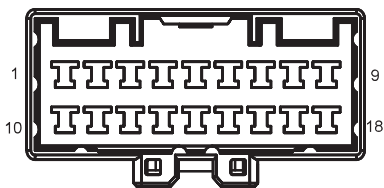

I1_MR Main Harness to Roof Harness

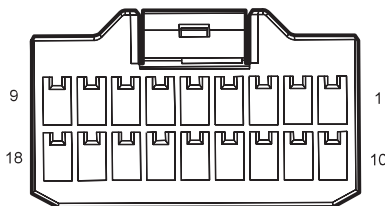

I1_WT Tailgate Harness to Tailgate Transition Harness

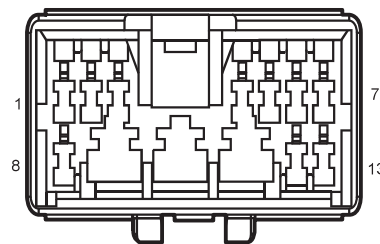

M02 BCM c 3

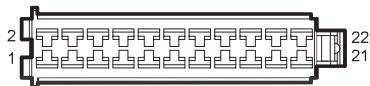

M05 BCM C1

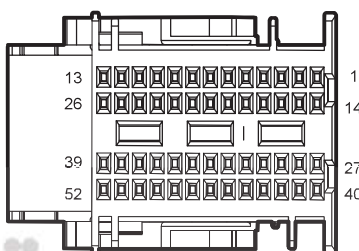

I3_EC Engine Harness to Control Harness; QNUtu

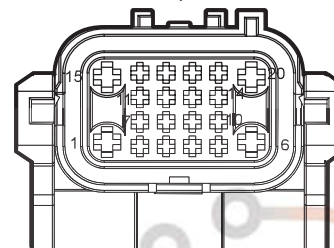

دیجیتال خودرو
شرکت دیجیتال خودرو سامانه (مسئولیت محدود)

اولین سامانه دیجیتال تعمیرکاران خودرو در ایران

