

دیجیتال خودرو  
 شرکت دیجیتال خودرو سامانه (مسئولیت محدود)

اولین سامانه دیجیتال تعمیرکاران خودرو در ایران

- \* 5 : From Sep. 2012 Production
- \* 6 : Before Sep. 2014 Production
- \* 7 : From Sep. 2014 Production

A28  
Skid Control ECU with Actuator (Brake Booster with Master Cylinder Assembly)

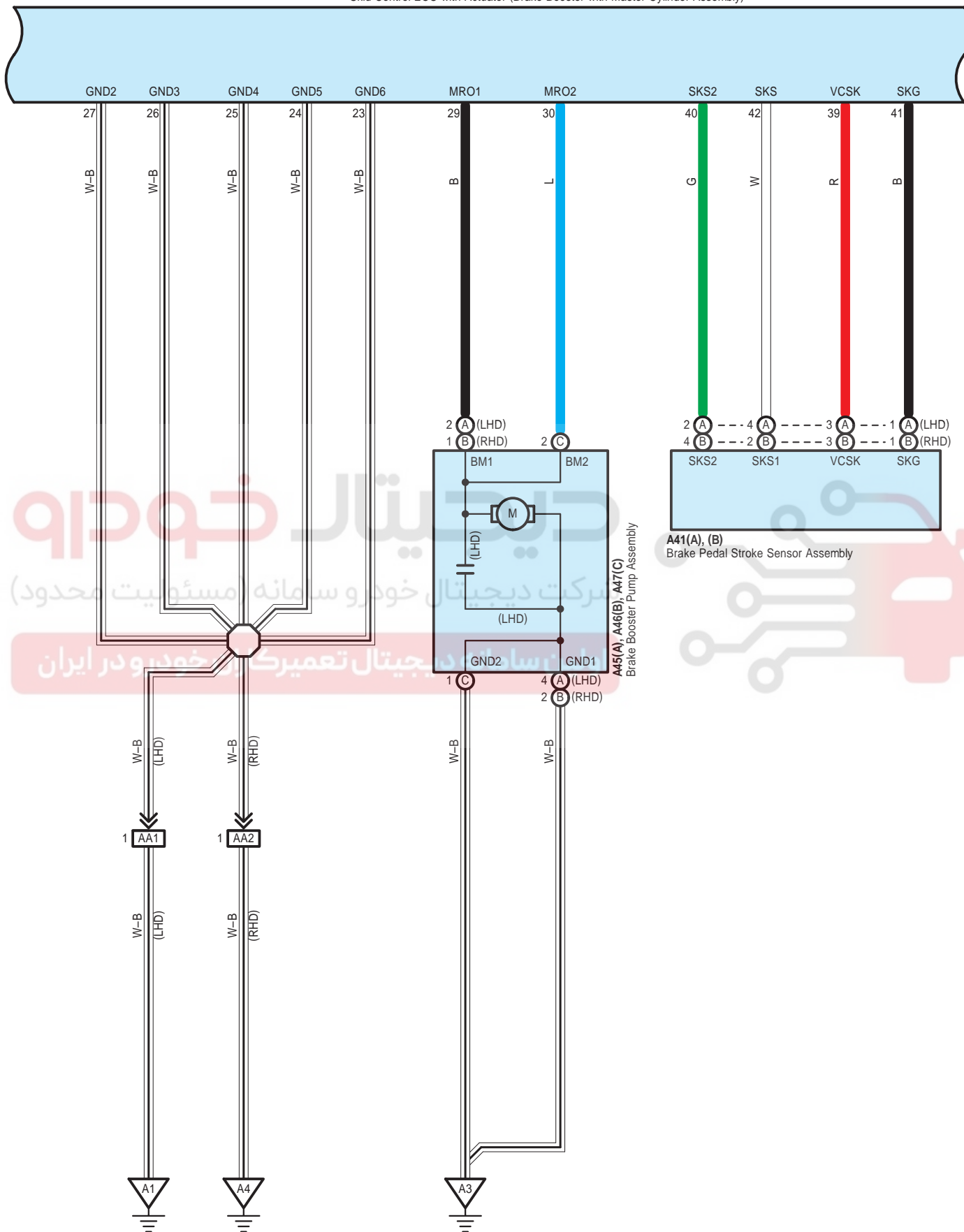

A28  
Skid Control ECU with Actuator (Brake Booster with Master Cylinder Assembly)

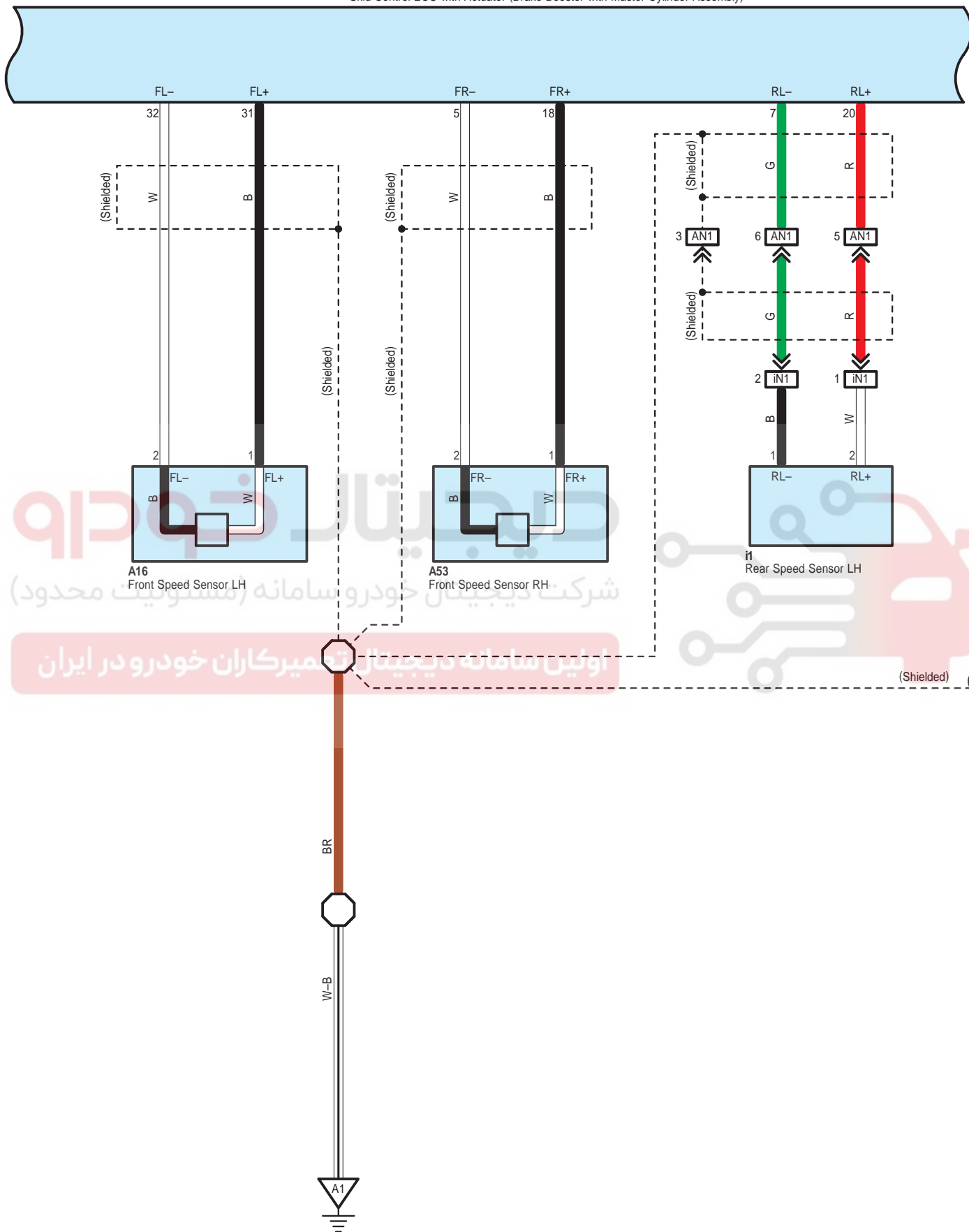

اولین سامانه دیجیتال تعمیرکاران خودرو در ایران  
شرکت دیجیتال خودرو سامانه (تعمیرات محدود)

A28  
Skid Control ECU with Actuator (Brake Booster with Master Cylinder Assembly)

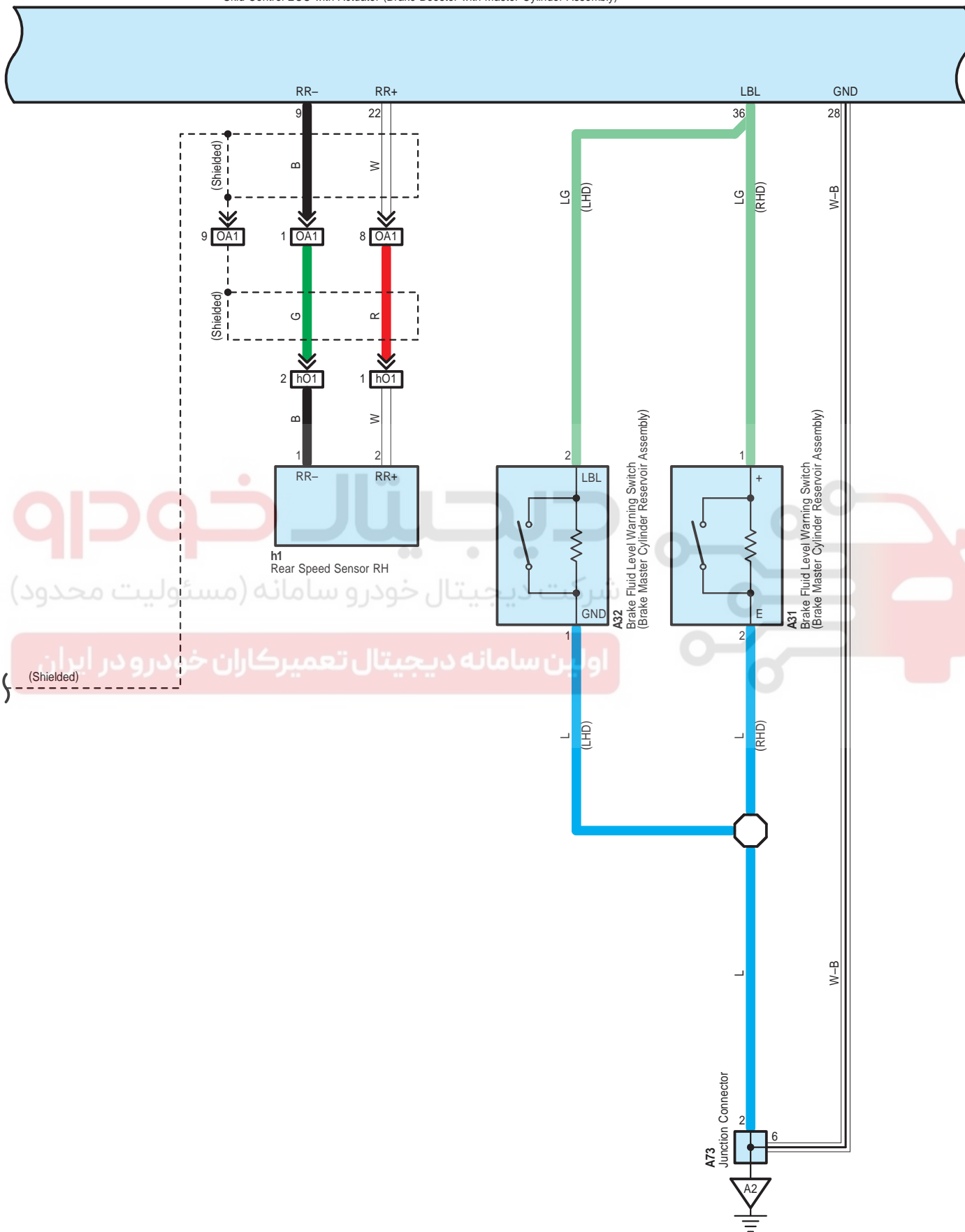

A28  
Skid Control ECU with Actuator (Brake Booster with Master Cylinder Assembly)

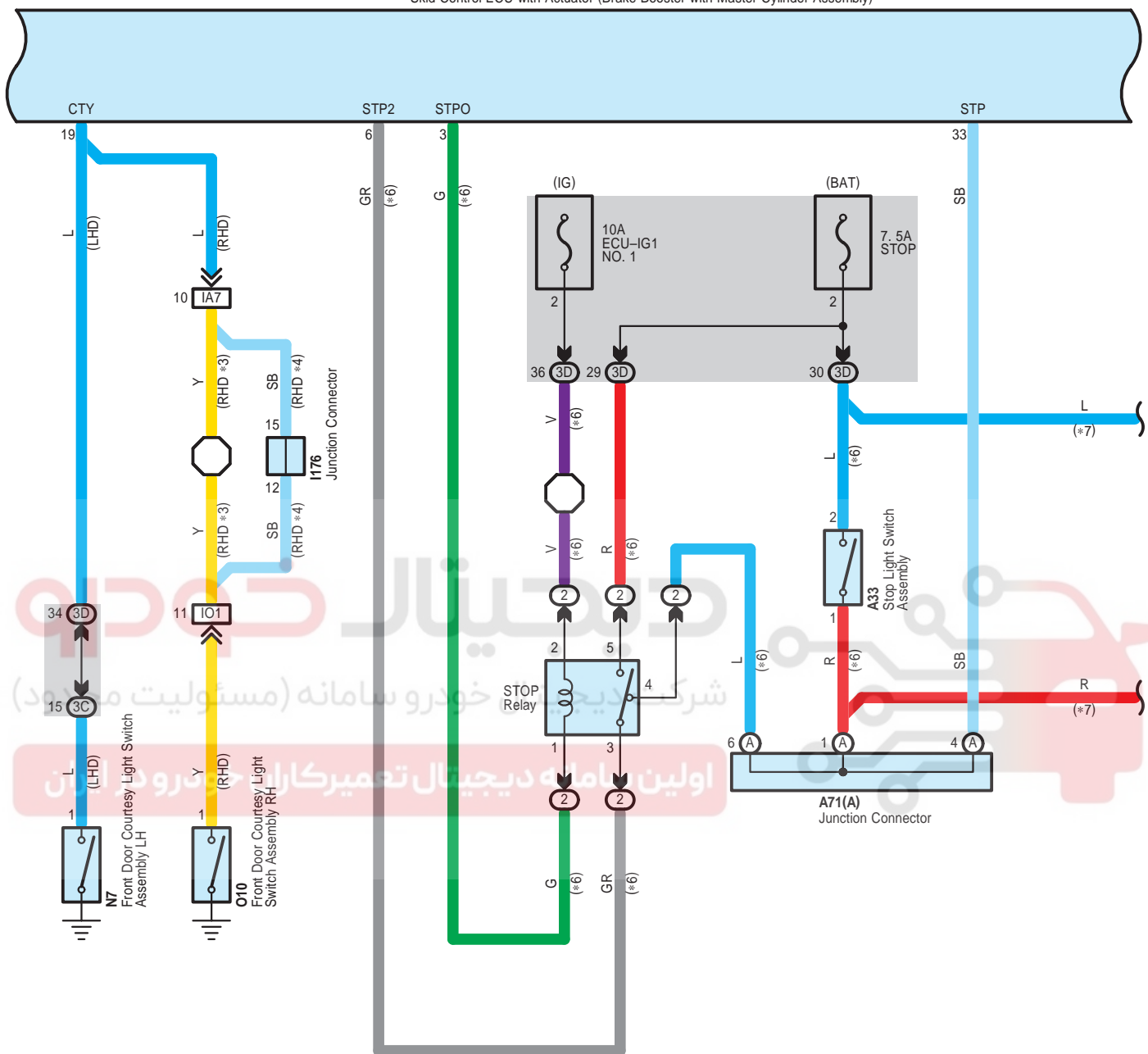

\* 3 : Before Jan. 2012 Production, From Sep. 2013 Production  
 \* 4 : From Jan. 2012 Production until Sep. 2013 Production  
 \* 6 : Before Sep. 2014 Production  
 \* 7 : From Sep. 2014 Production

A28  
Skid Control ECU with Actuator (Brake Booster with Master Cylinder Assembly)

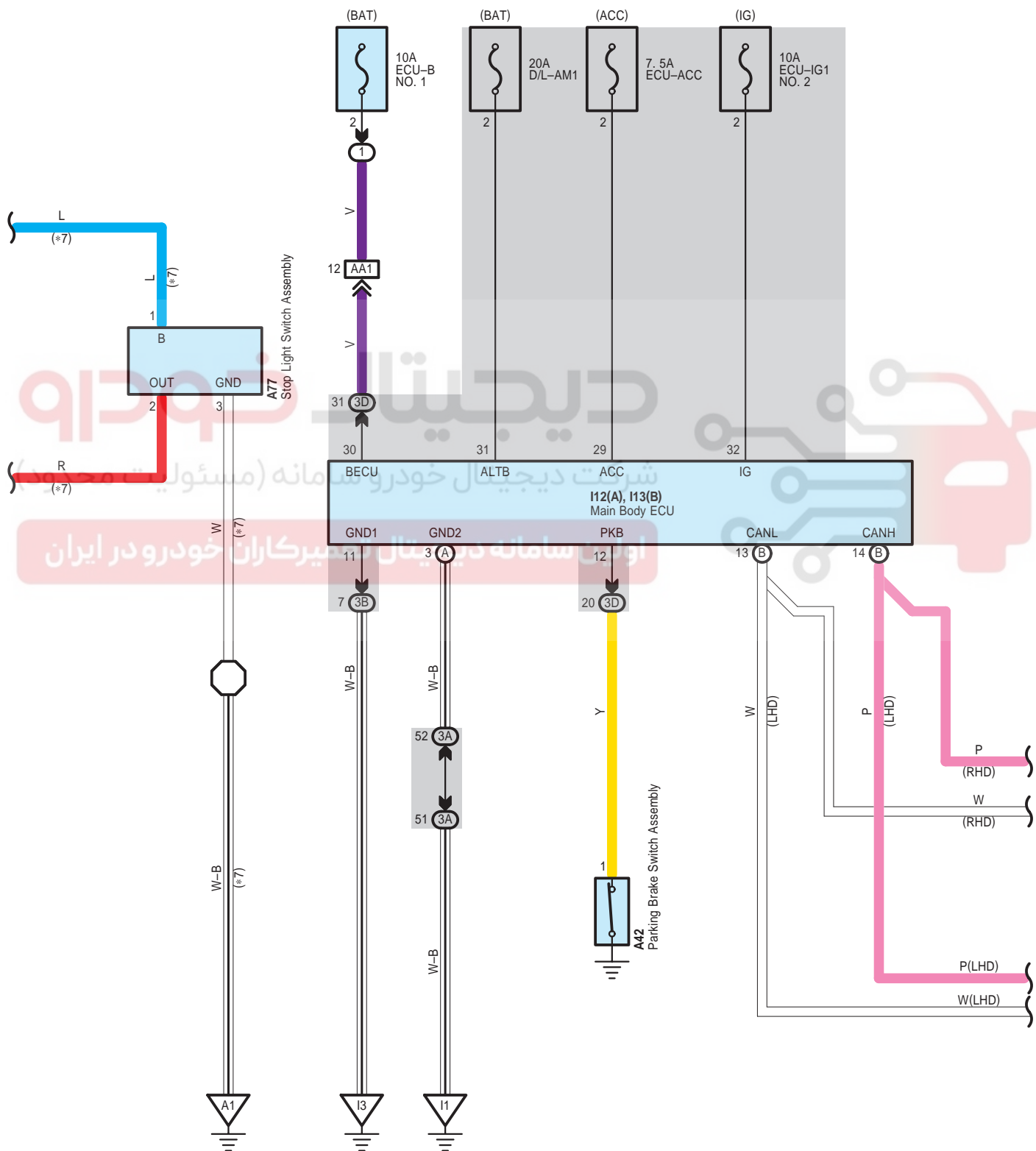

A28  
Skid Control ECU with Actuator (Brake Booster with Master Cylinder Assembly)

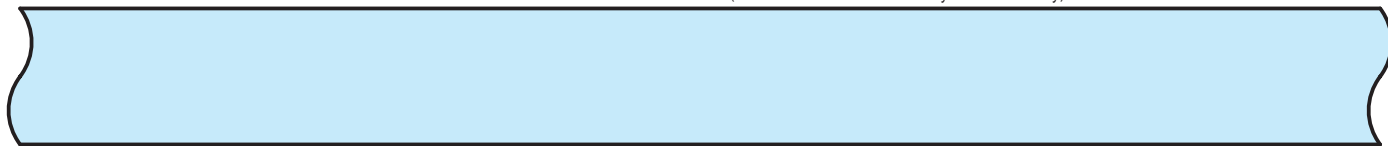

- \* 1 : Separate Type Yaw Rate Sensor
- \* 2 : Built-in Type Yaw Rate Sensor

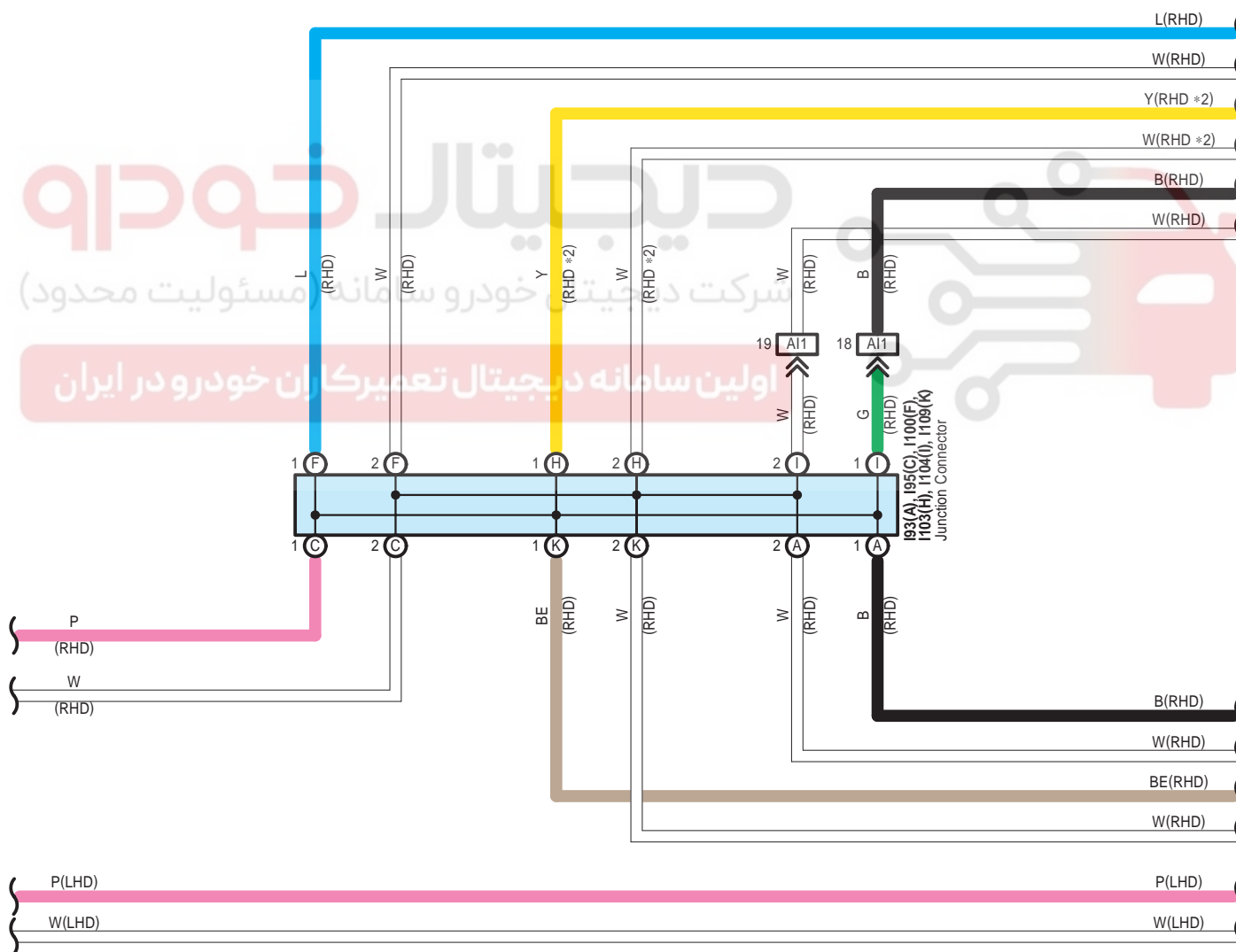

A28  
Skid Control ECU with Actuator (Brake Booster with Master Cylinder Assembly)

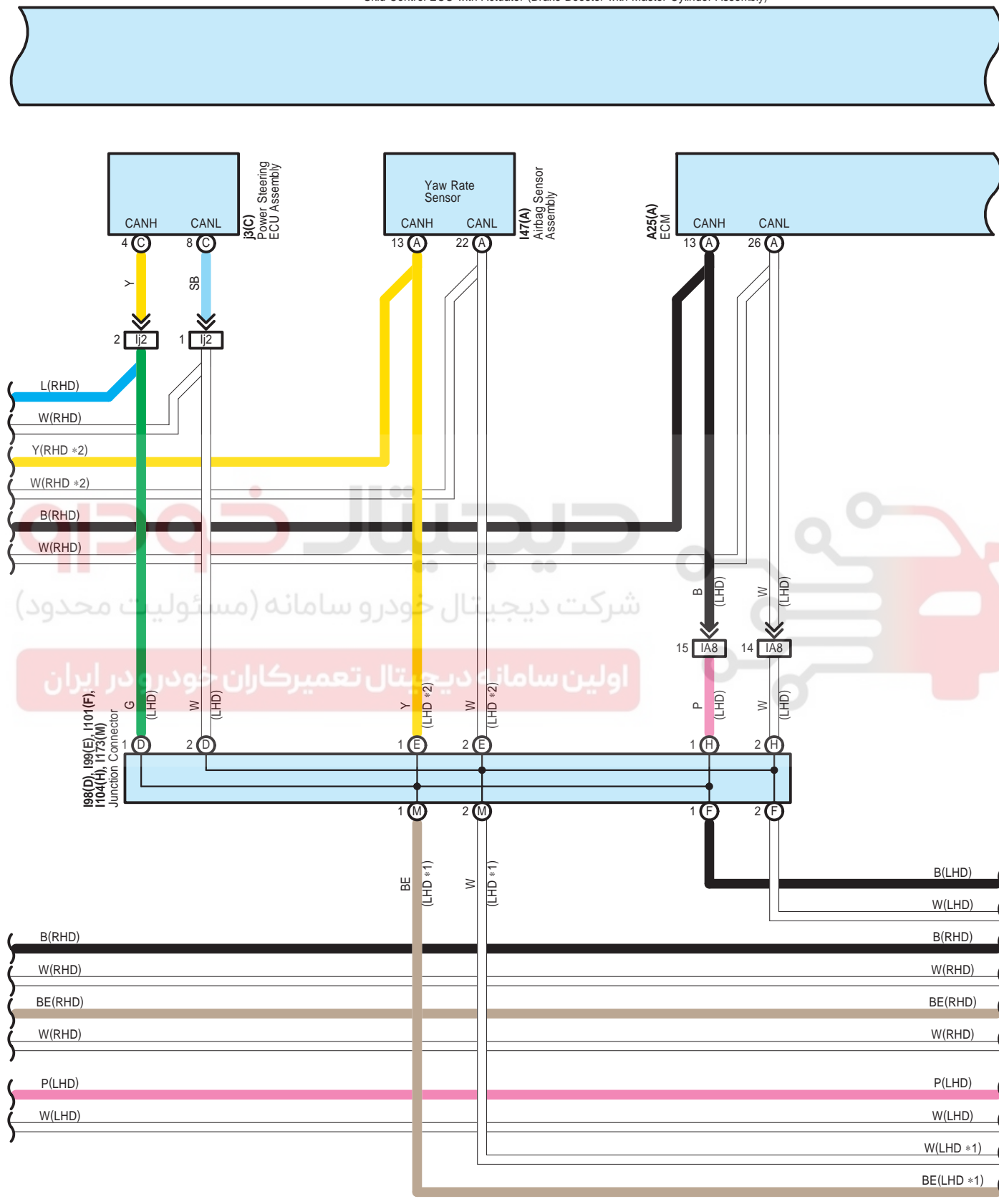



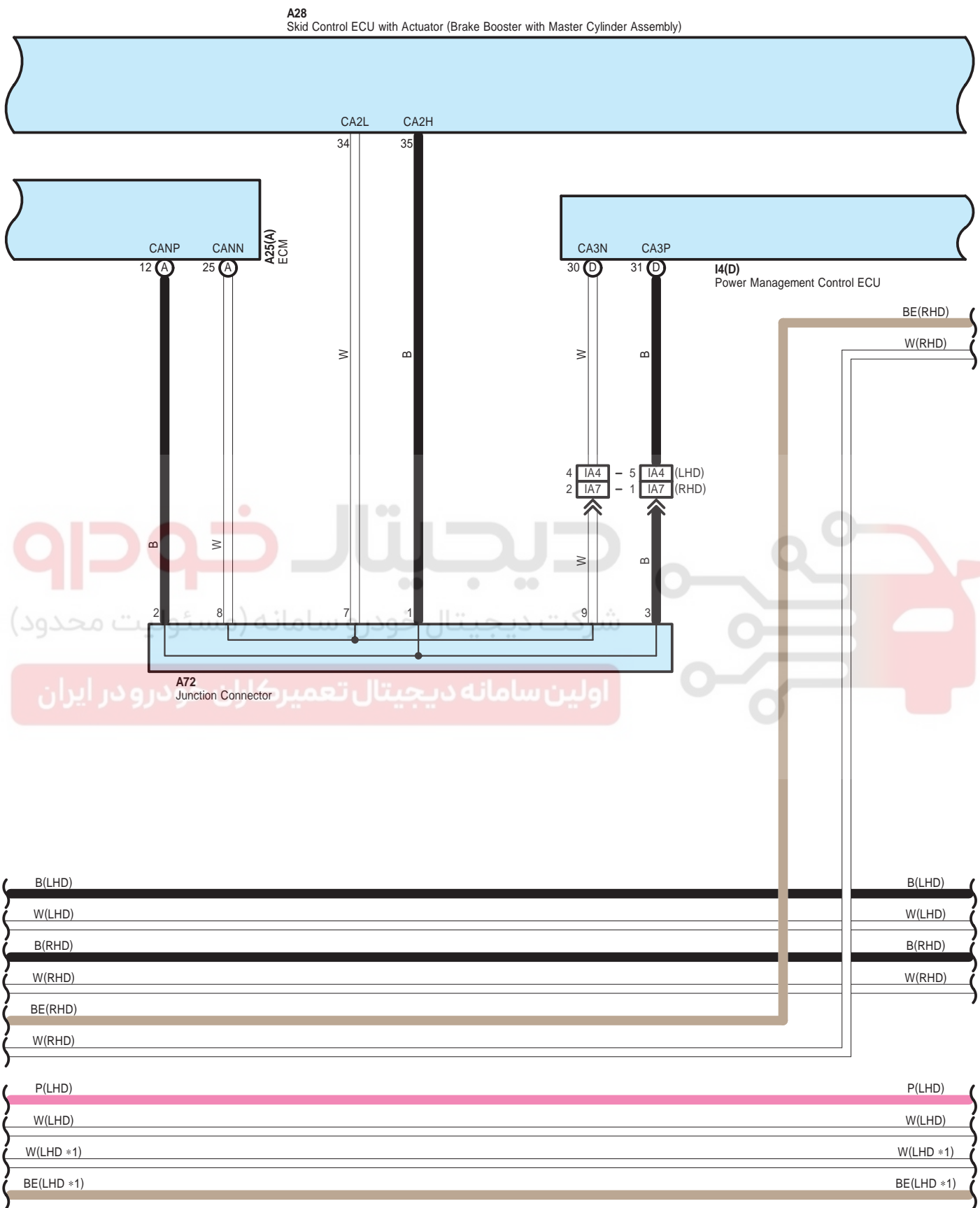

ABS , Brake Assist , EBD , Hill-Start Assist Control , TRC , VSC

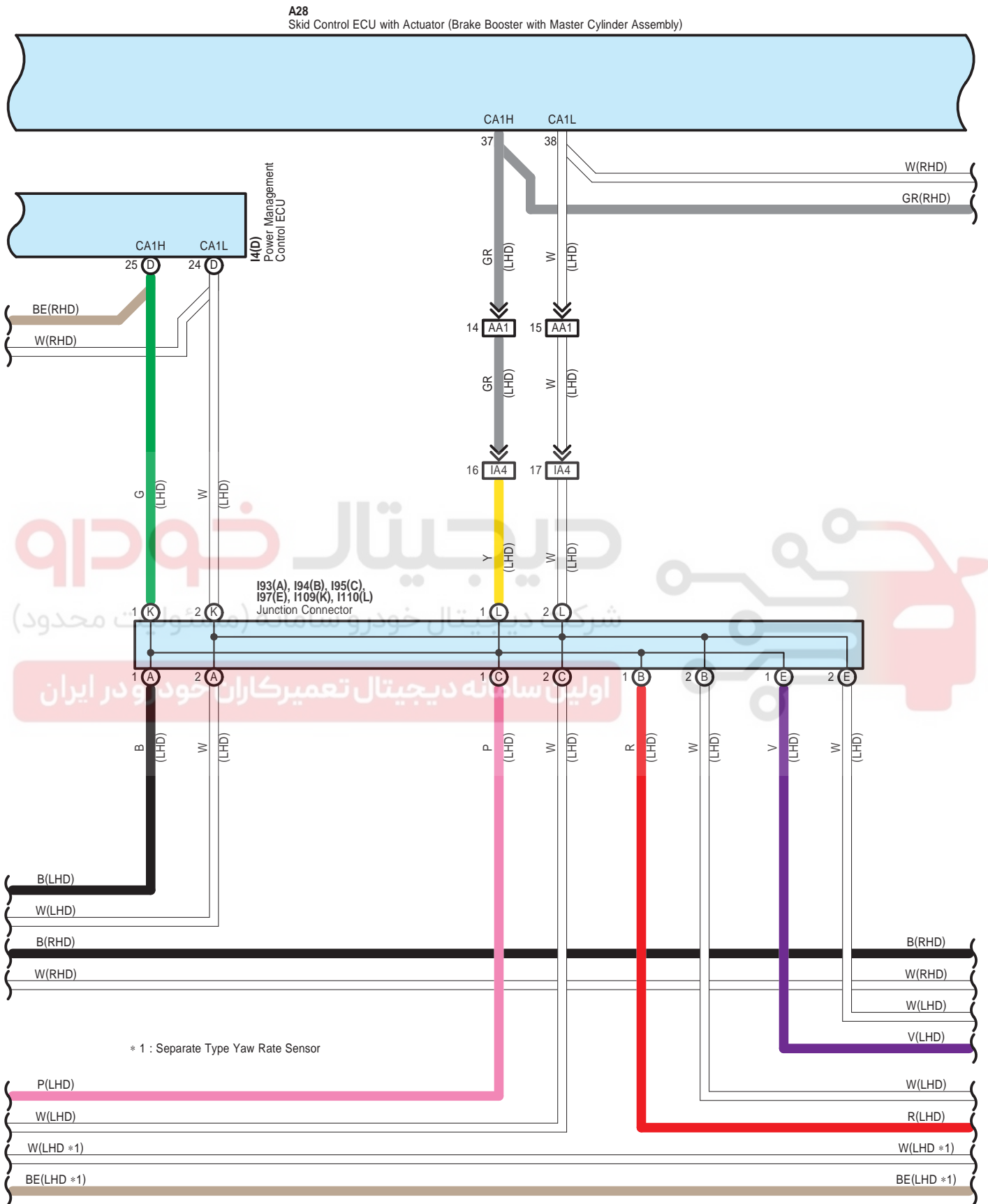



ABS , Brake Assist , EBD , Hill-Start Assist Control , TRC , VSC

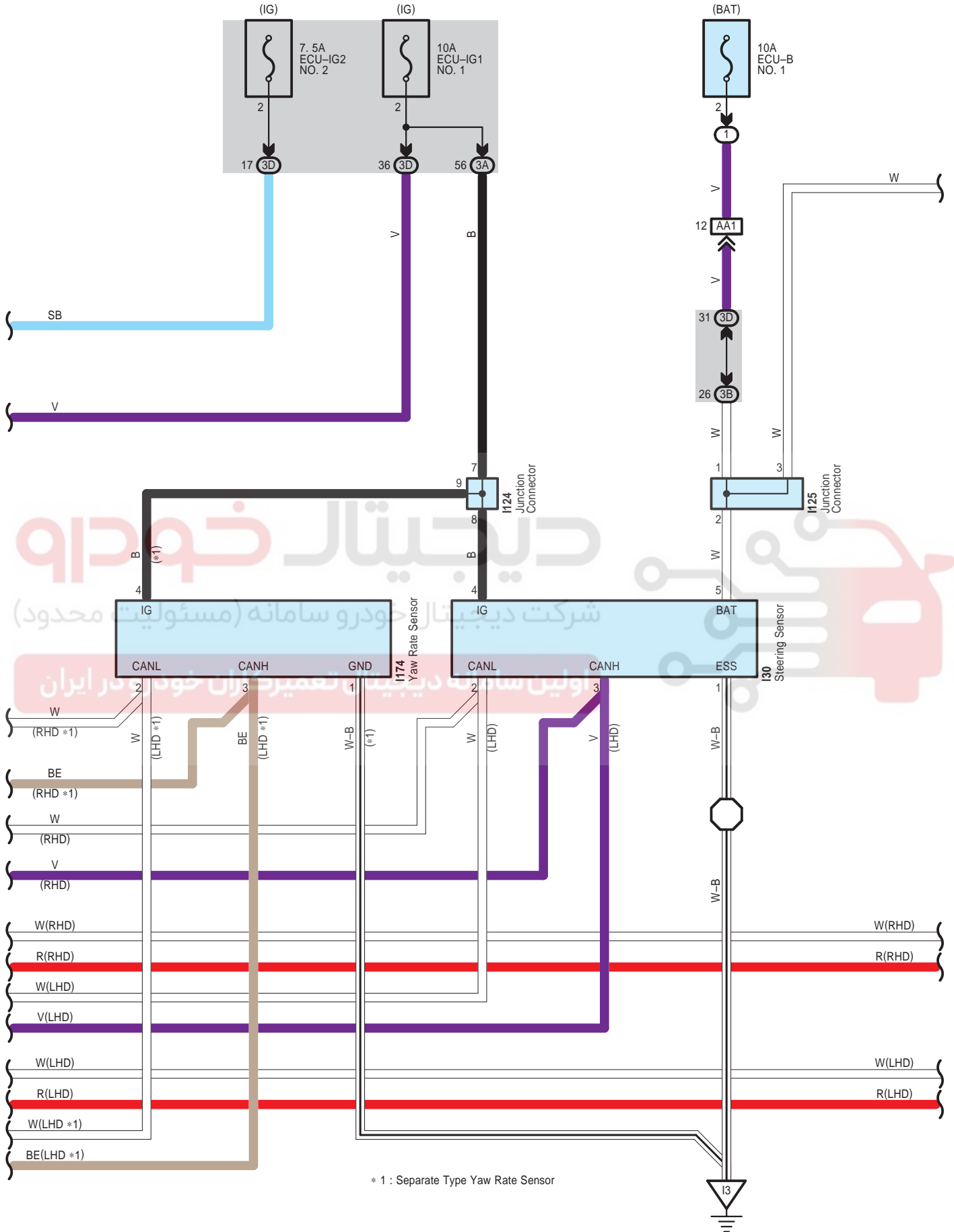

\* 1 : Separate Type Yaw Rate Sensor

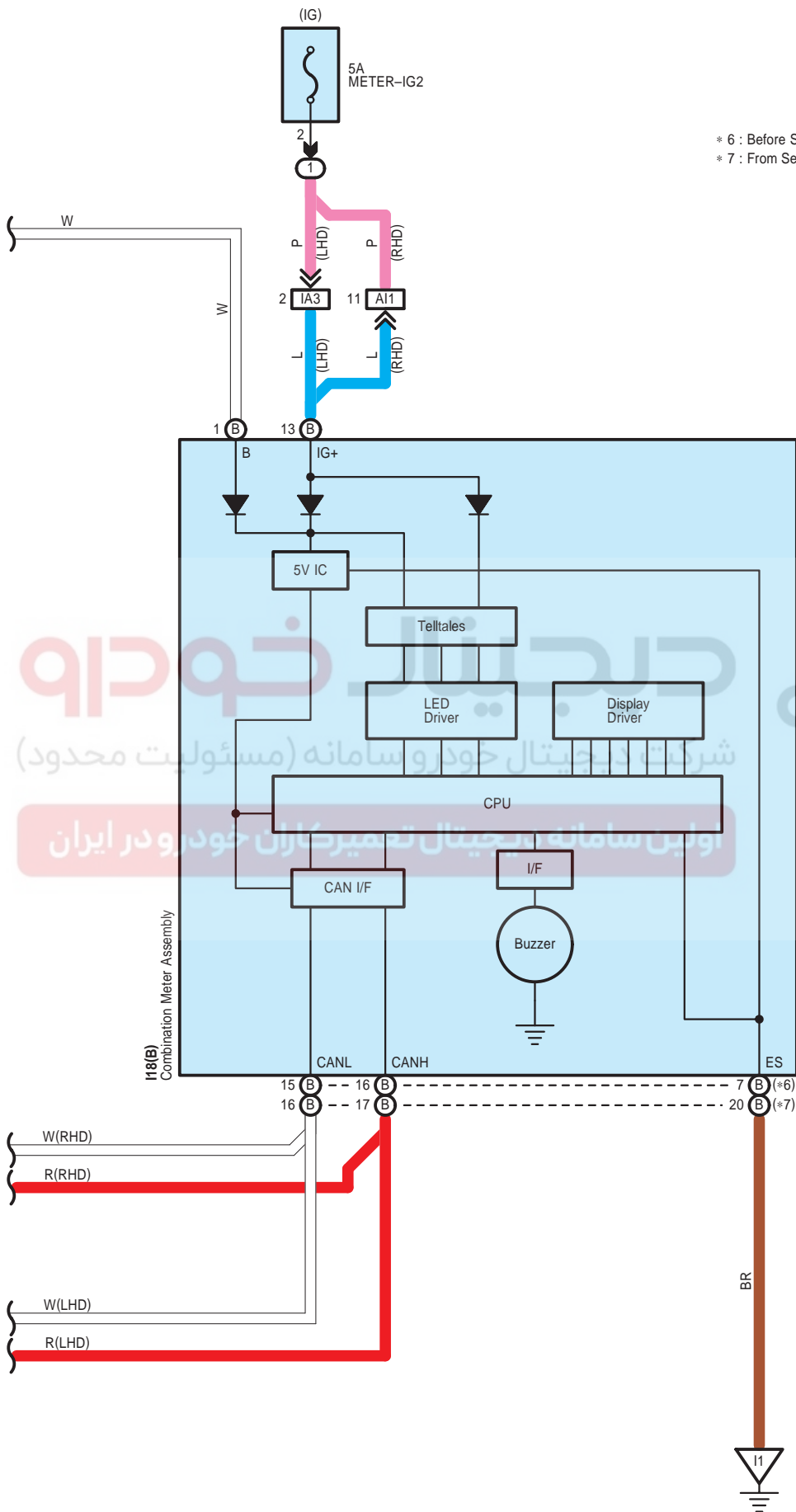

\* 6 : Before Sep. 2014 Production  
\* 7 : From Sep. 2014 Production

دیجیتال خودرو  
شرکت دیجیتال خودرو سامانه (مسئولیت محدود)  
اولین سامانه دیجیتال تعمیرکاران خودرو در ایران



ABS , Brake Assist , EBD , Hill-Start Assist Control , TRC , VSC

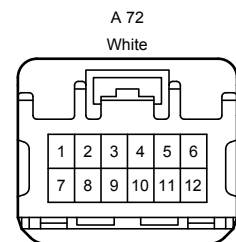
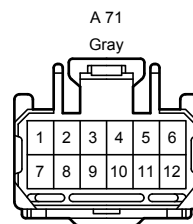
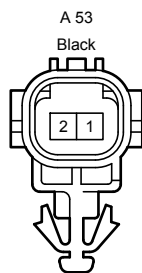
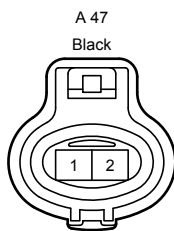
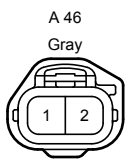
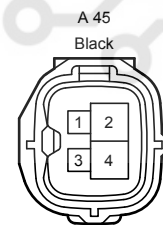
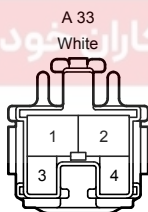
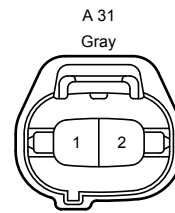
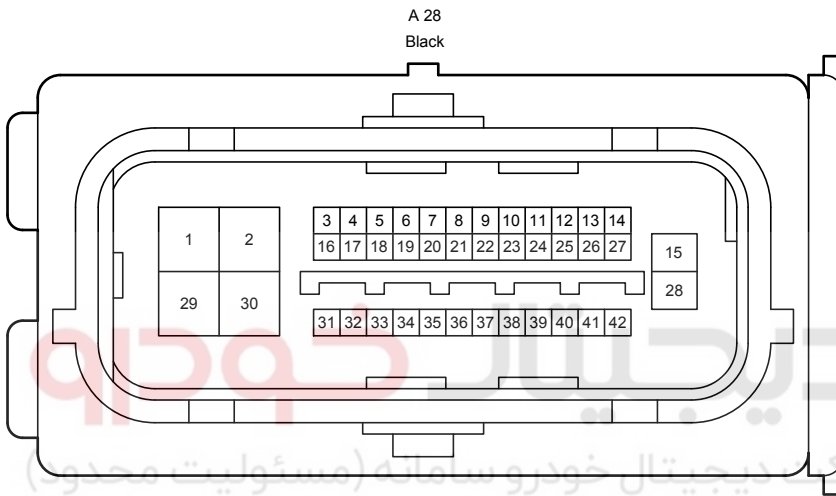
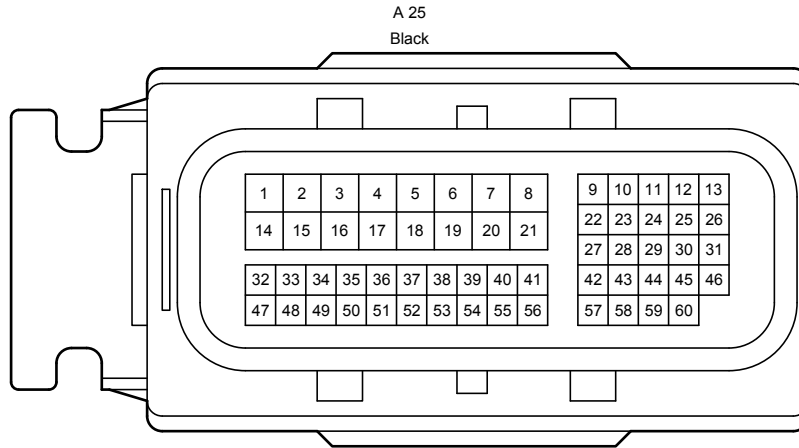
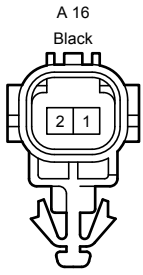



ABS , Brake Assist , EBD , Hill-Start Assist Control , TRC , VSC

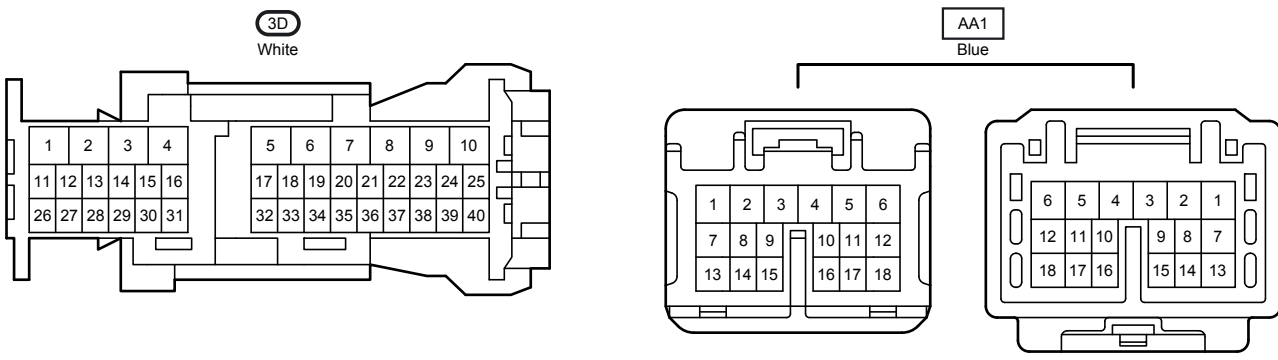
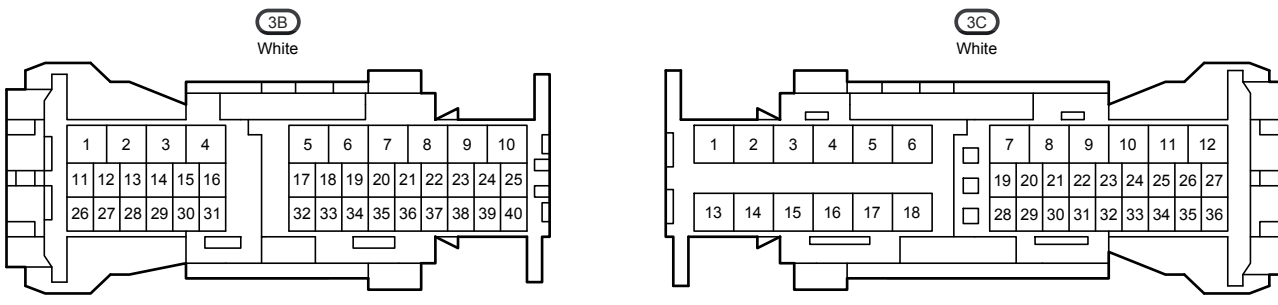
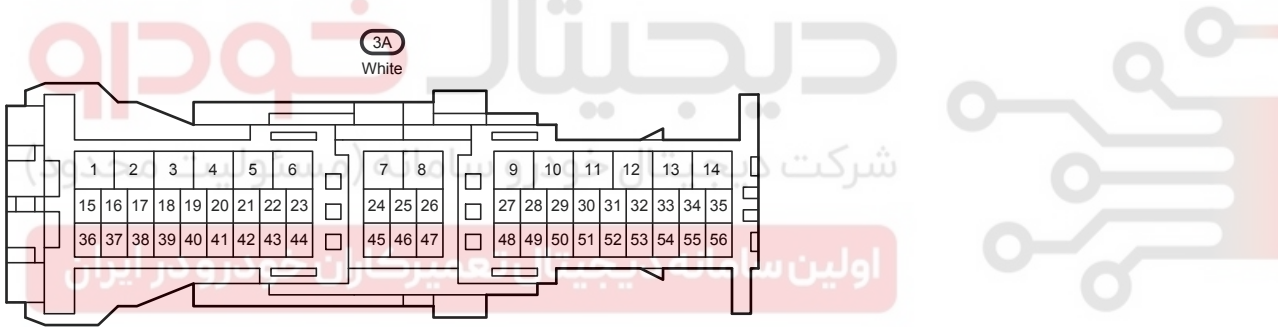
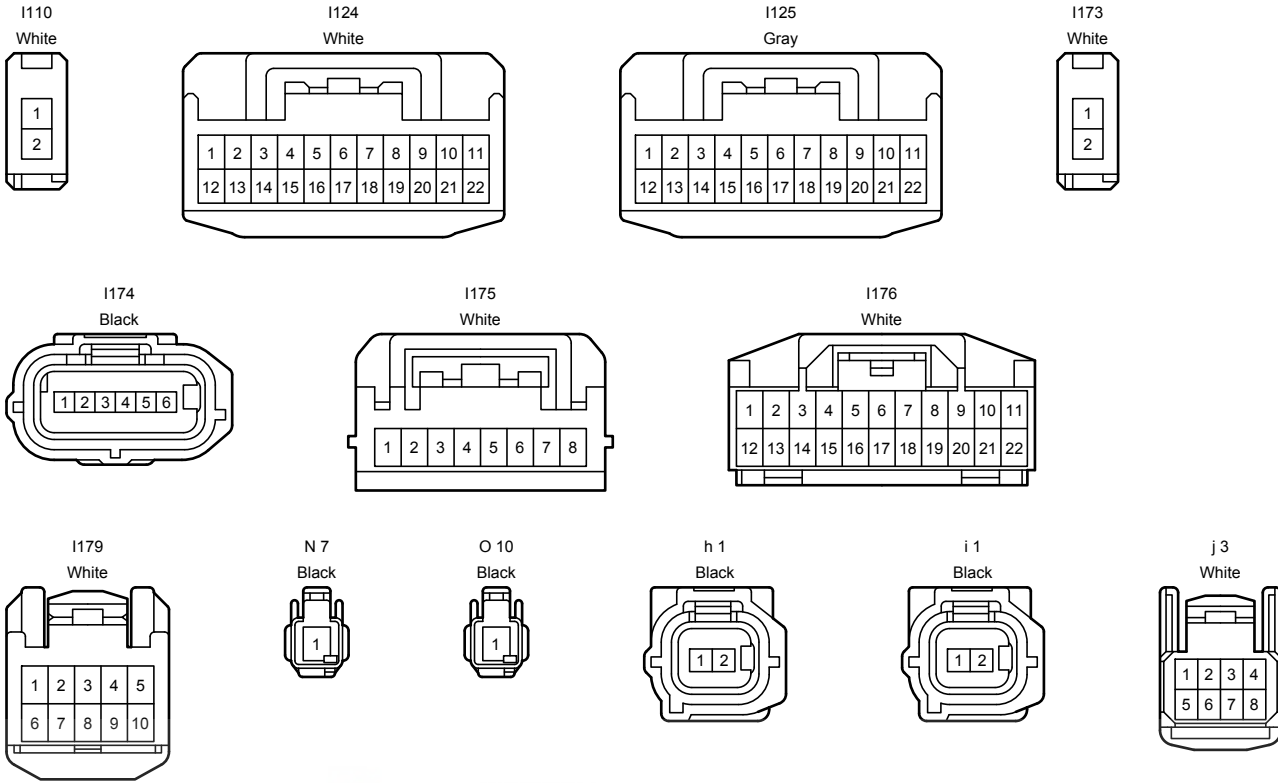



AA2  
White

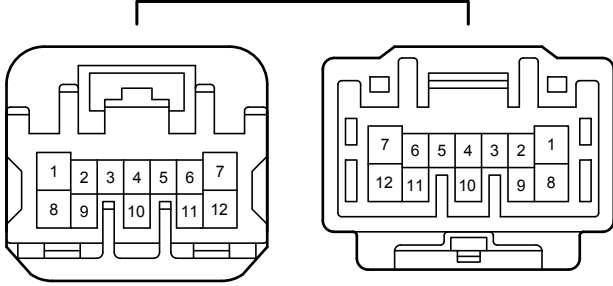

A11  
White

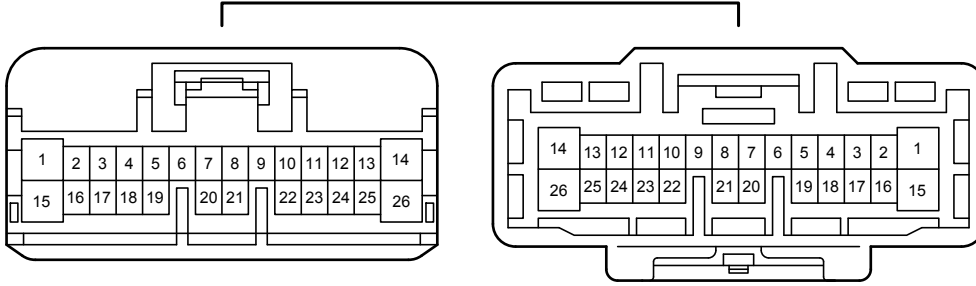

AN1  
White

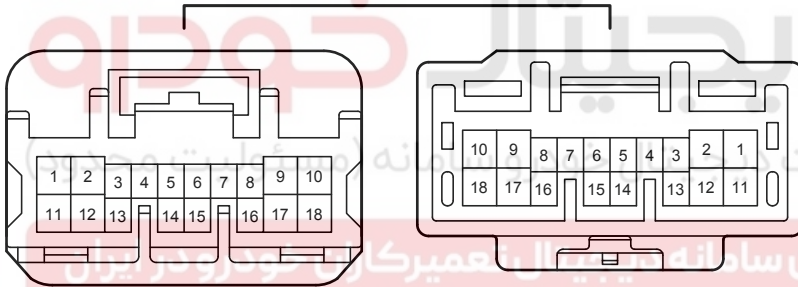

IA3  
Blue

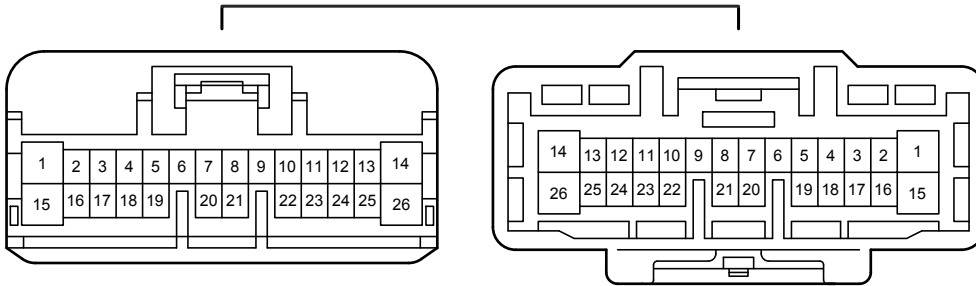

IA4  
Gray

