

Door Lock Control (Except Korea) (Before Oct. 2015 Production)

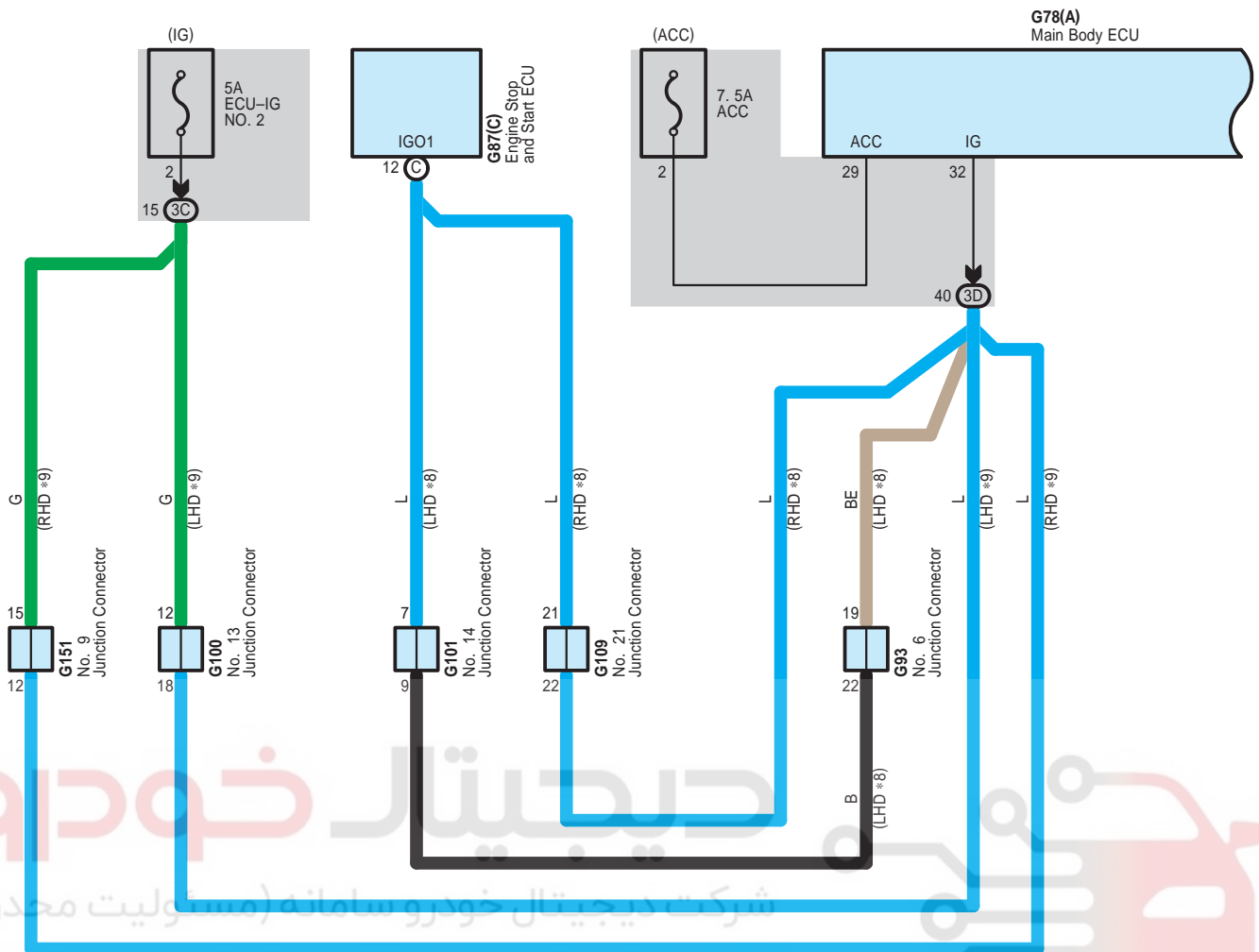

- \* 8 : w/ Stop & Start System
- \* 9 : w/o Stop & Start System
- \*29 : w/ Double Locking
- \*30 : w/o Double Locking
- \*37 : w/ Entry & Start System

Door Lock Control (Korea) (Before Oct. 2015 Production)

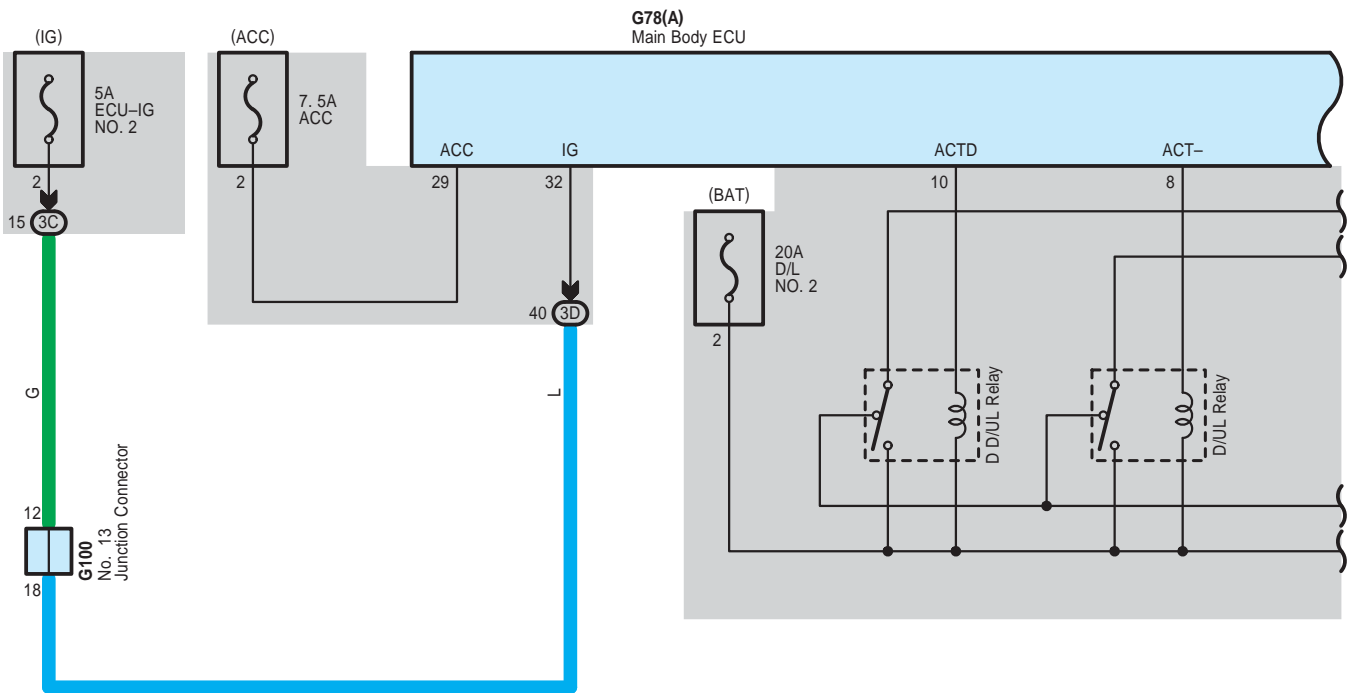

# دیجیتال خودرو

شرکت دیجیتال خودرو سامانه (مسئولیت محدود)

اولین سامانه دیجیتال تعمیرکاران خودرو در ایران



Door Lock Control (Korea) (Before Oct. 2015 Production)

G78(A)  
Main Body ECU

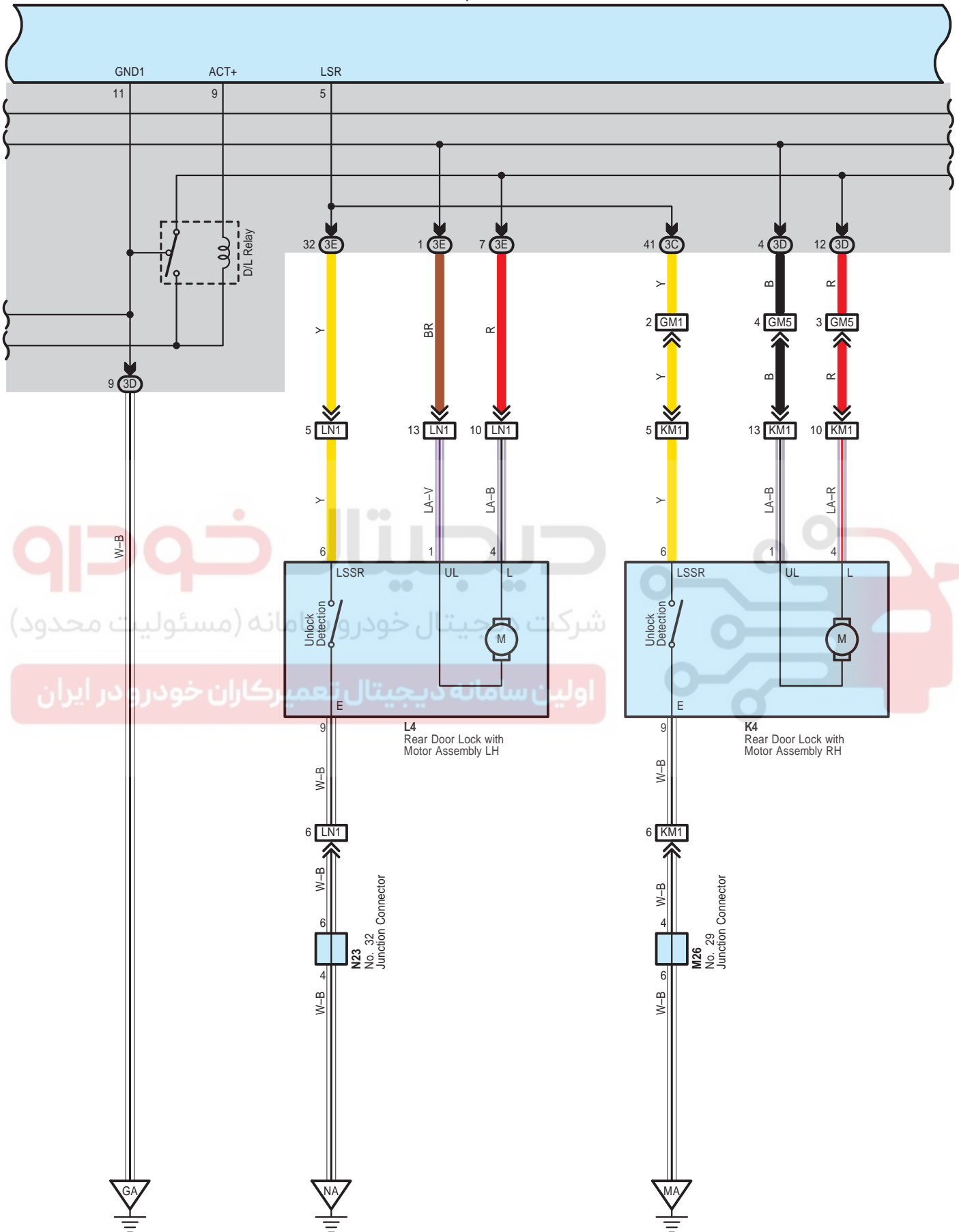

خودرو دیجیتال  
شرکت دیجیتال خودروه (مسئولیت محدود)  
اولین سامانه دیجیتال تعمیرکاران خودرو در ایران

Door Lock Control (Korea) (Before Oct. 2015 Production)

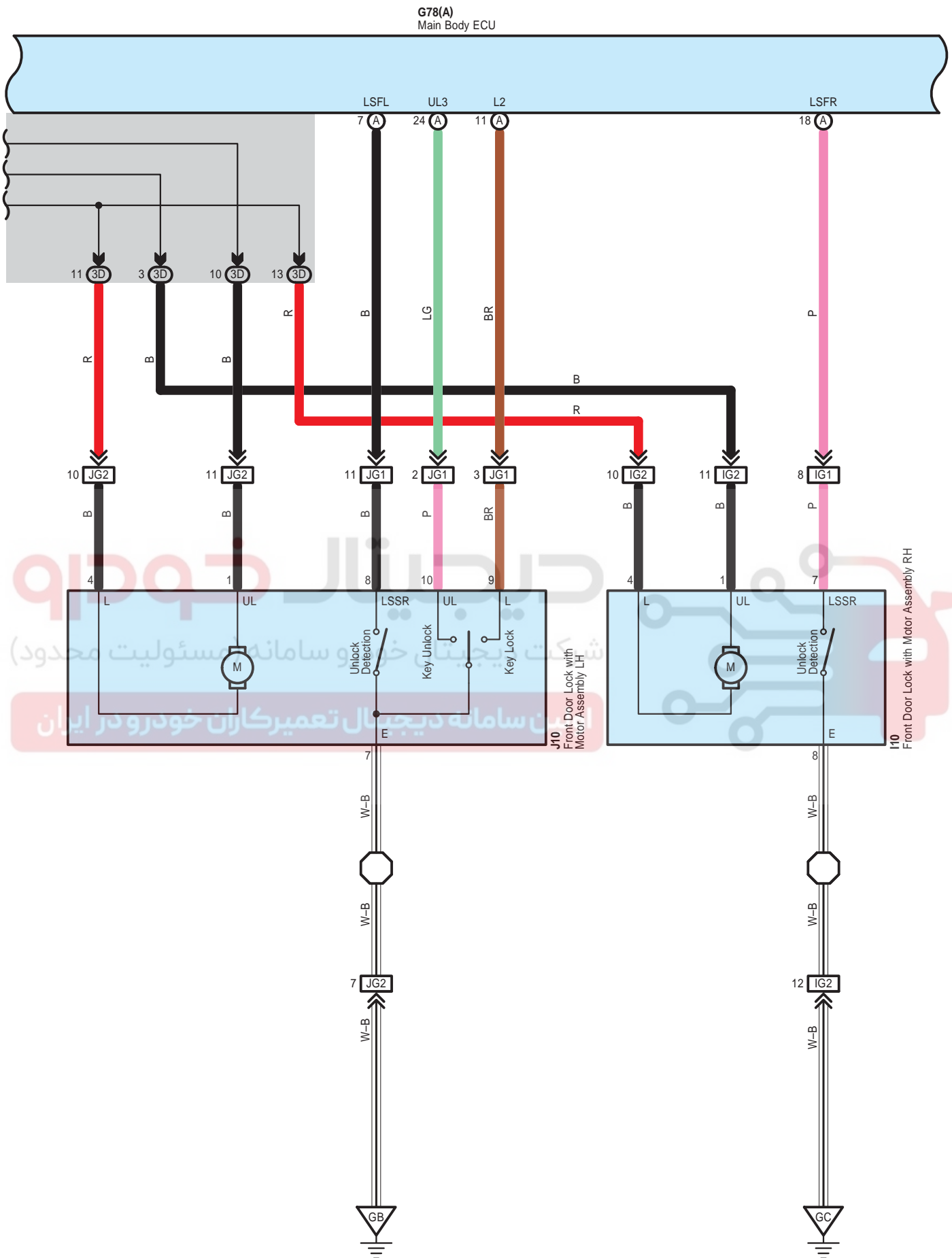

Door Lock Control (Korea) (Before Oct. 2015 Production)

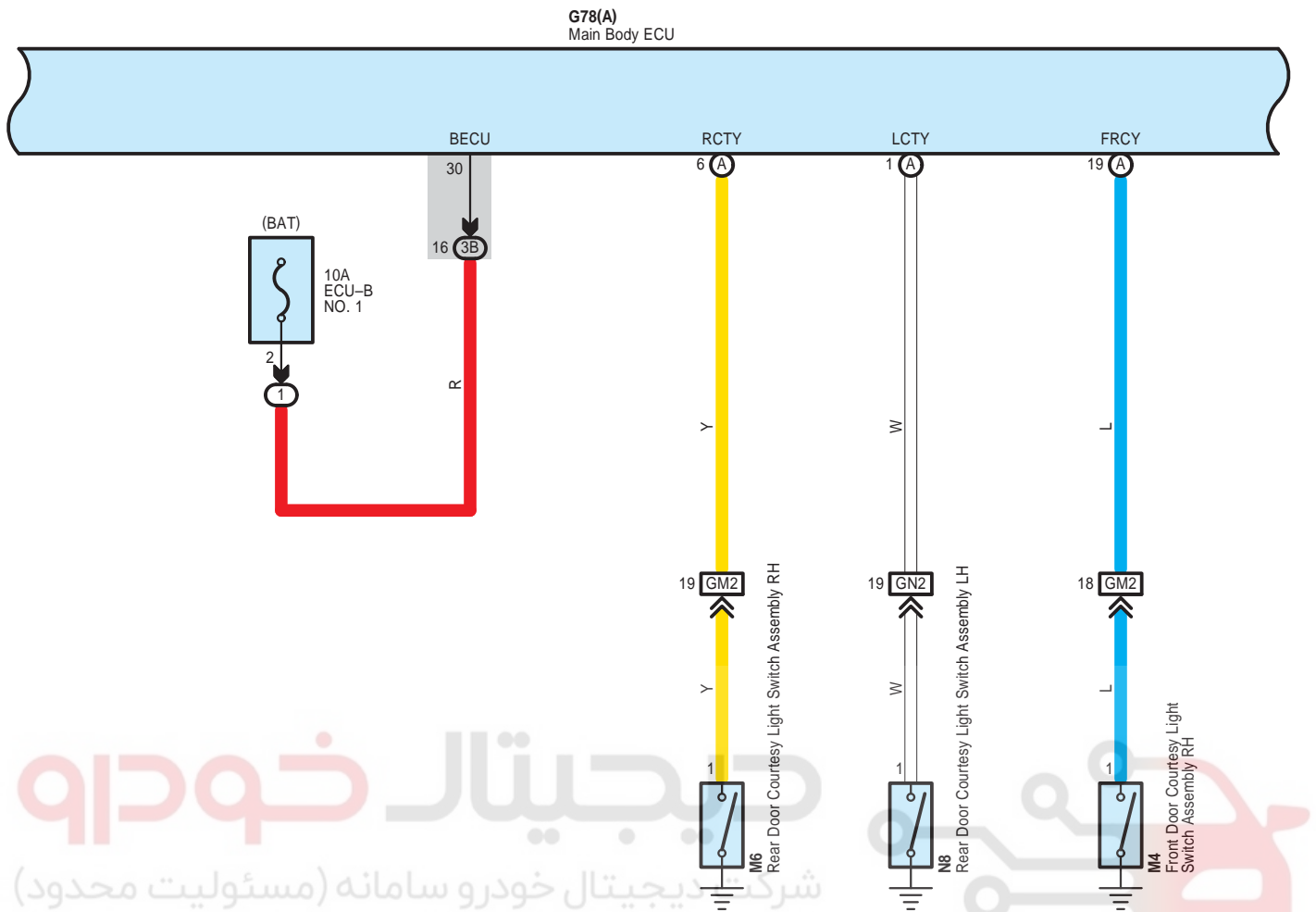

دیجیتال خودرو  
شرکت دیجیتال خودرو سامانه (مسئولیت محدود)

اولین سامانه دیجیتال تعمیرکاران خودرو در ایران

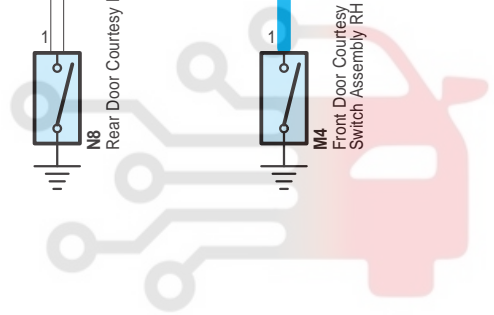

Door Lock Control (Korea) (Before Oct. 2015 Production)

G78(A)  
Main Body ECU

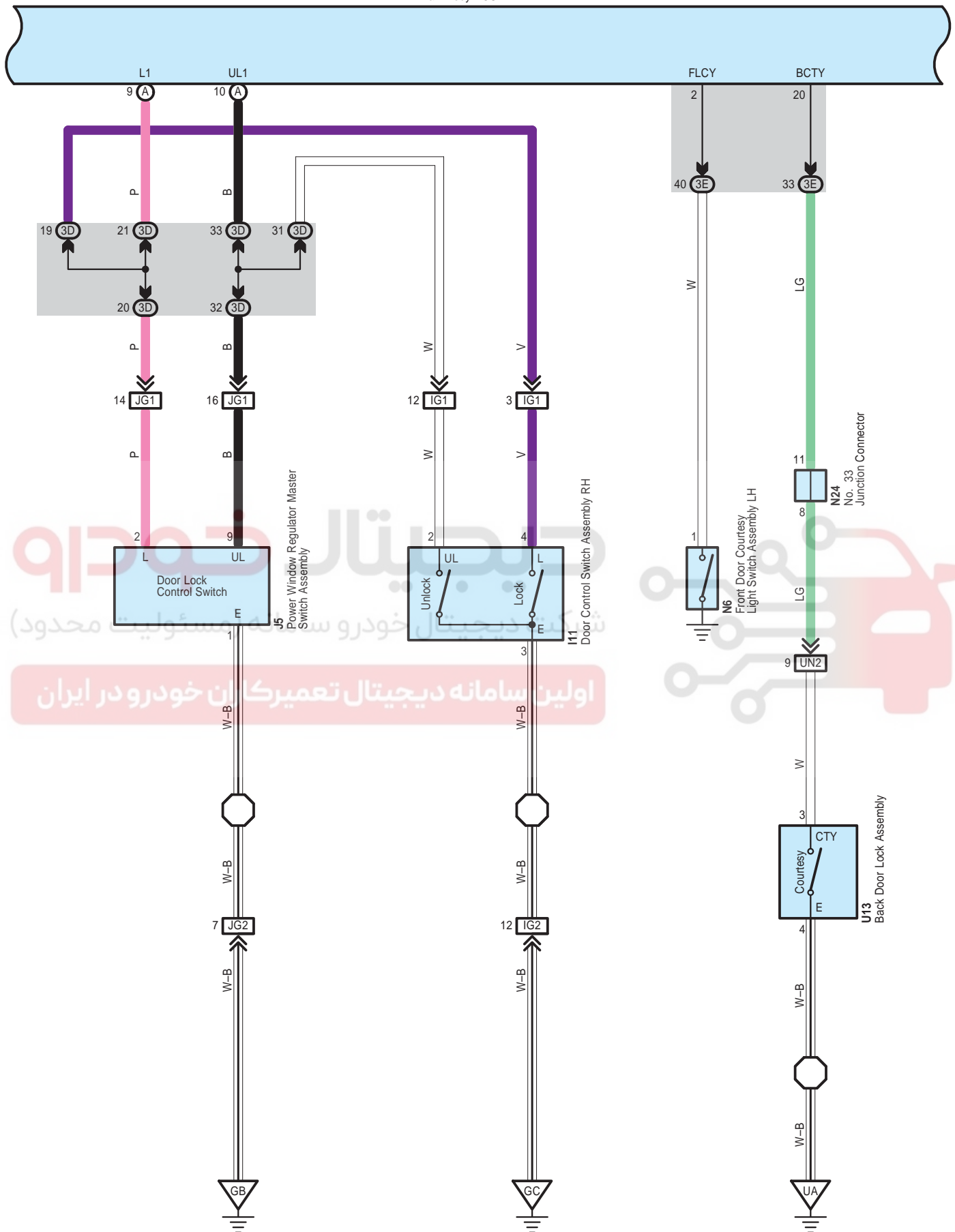

اولین سامانه دیجیتال تعمیرکاران خودرو ساز است (محدود)

Door Lock Control (Korea) (Before Oct. 2015 Production)

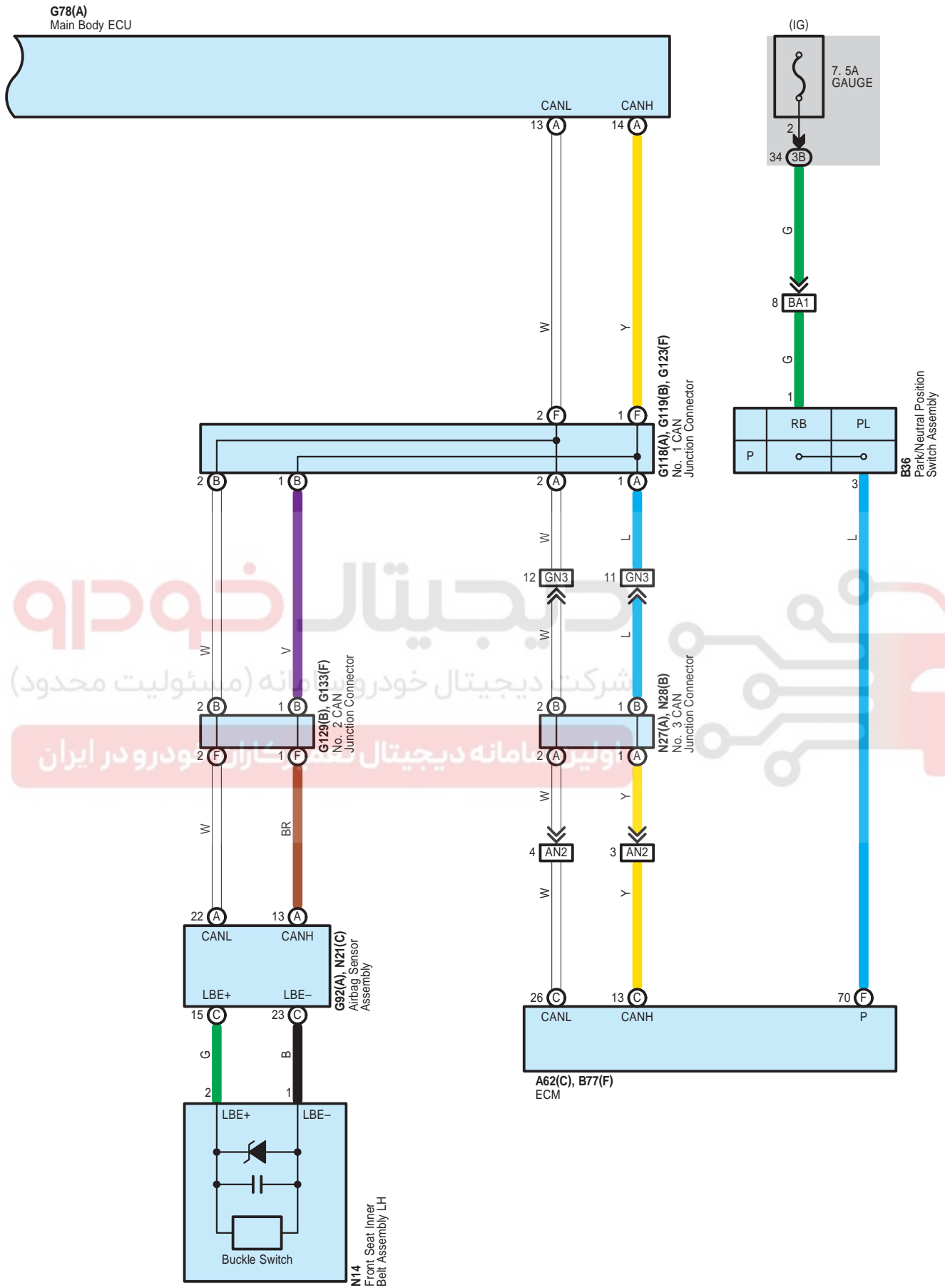

Door Lock Control (Korea) (Before Oct. 2015 Production)

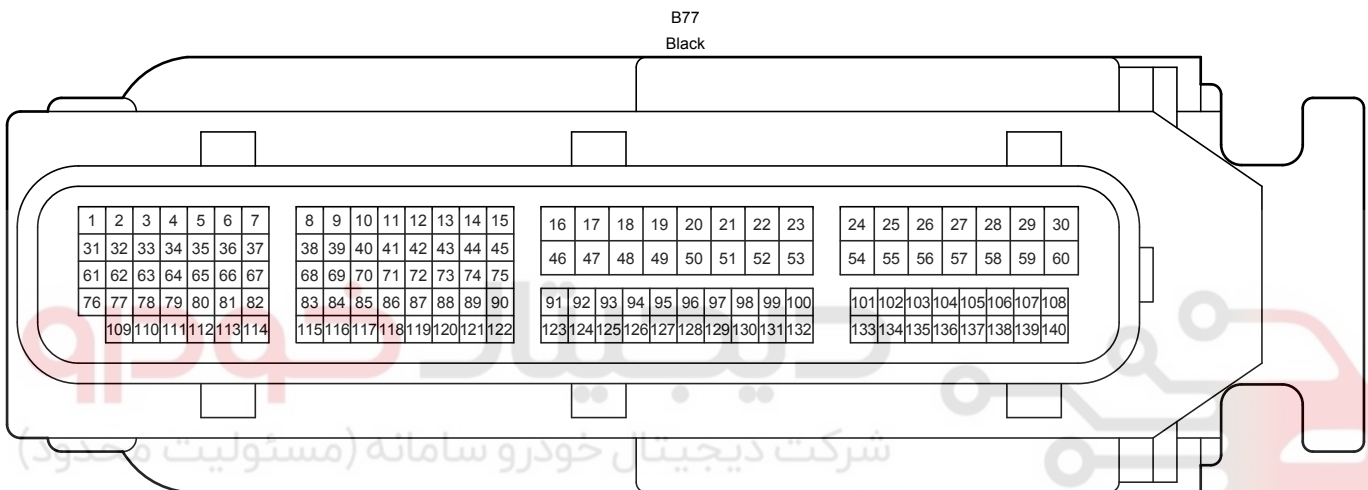
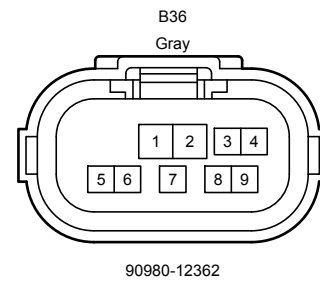
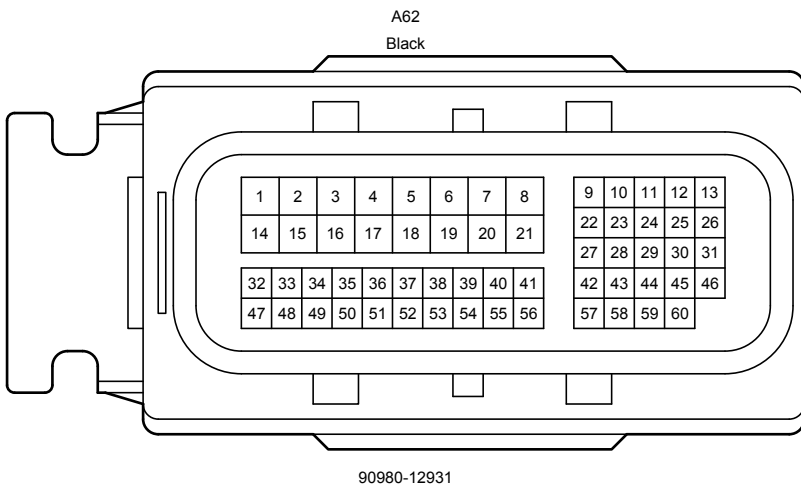

اولین سامانه دیجیتال تعمیرکاران خودرو در ایران

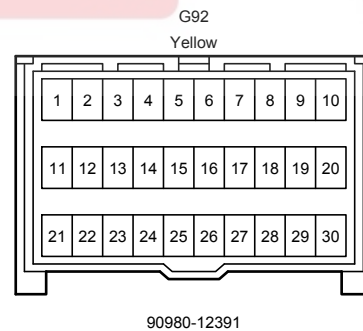
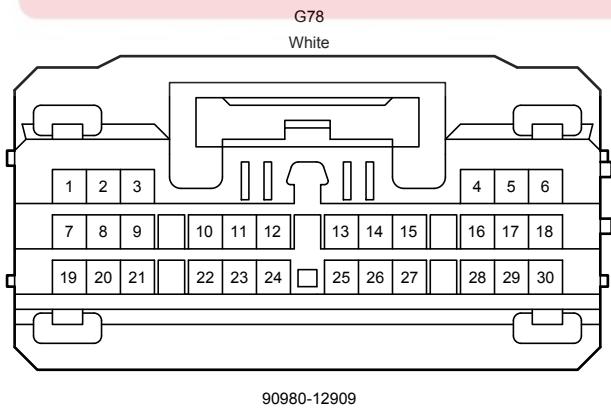



Door Lock Control (Korea) (Before Oct. 2015 Production)

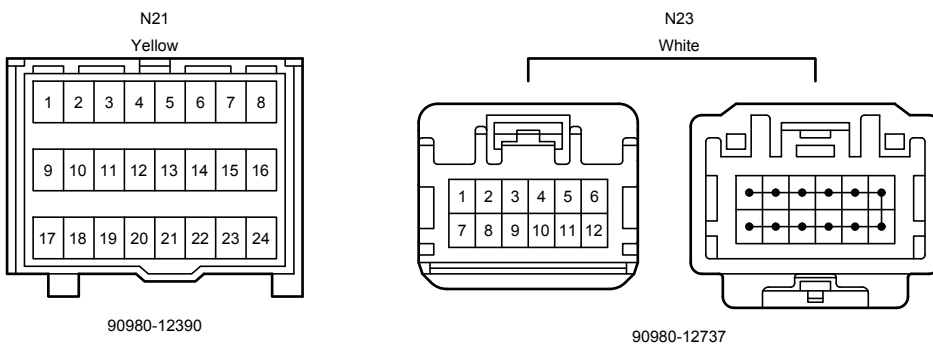
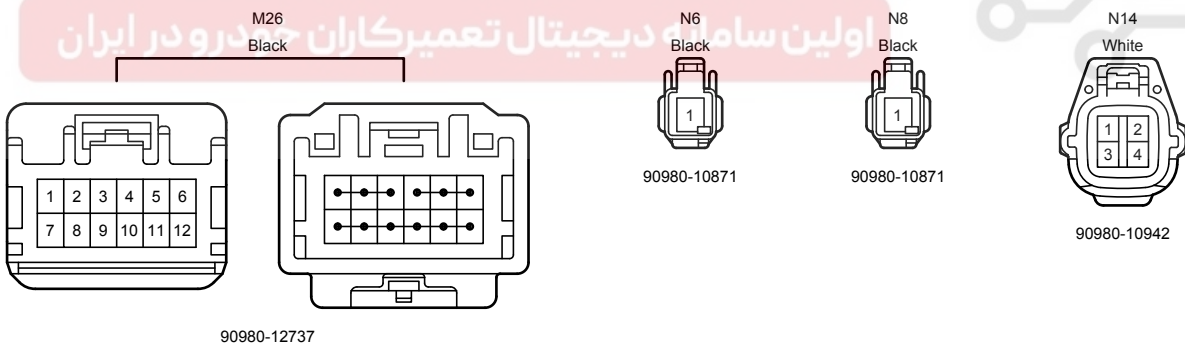
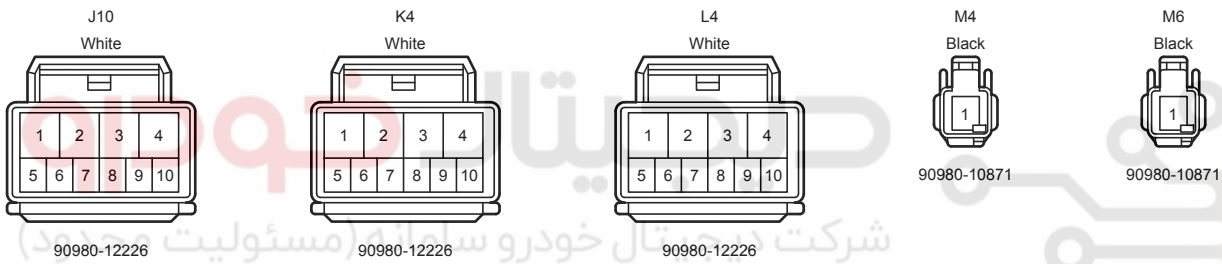
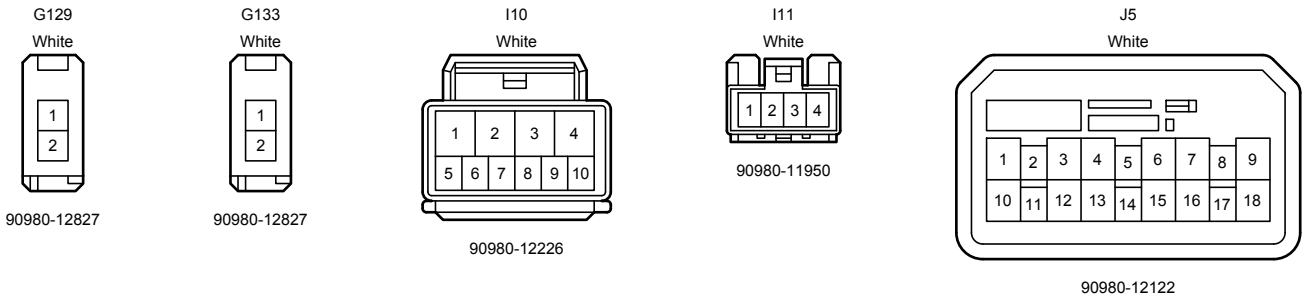
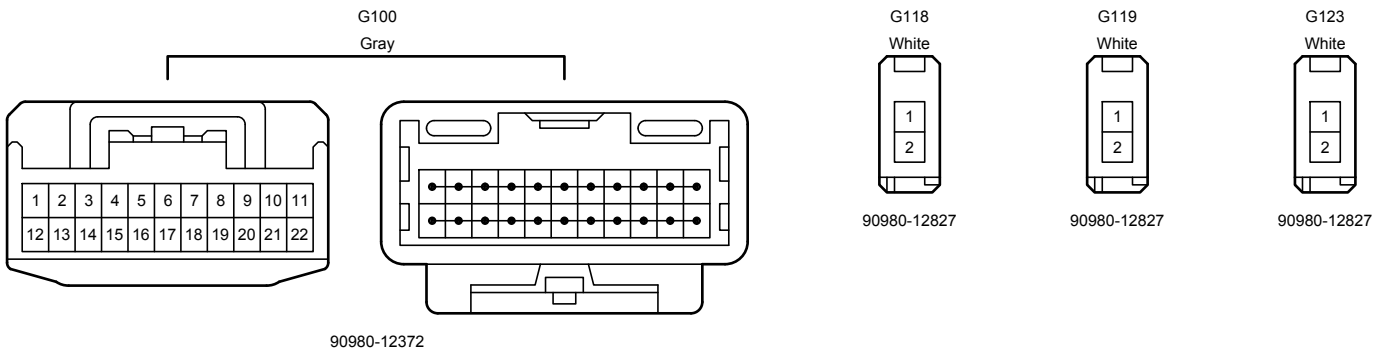

Door Lock Control (Korea) (Before Oct. 2015 Production)

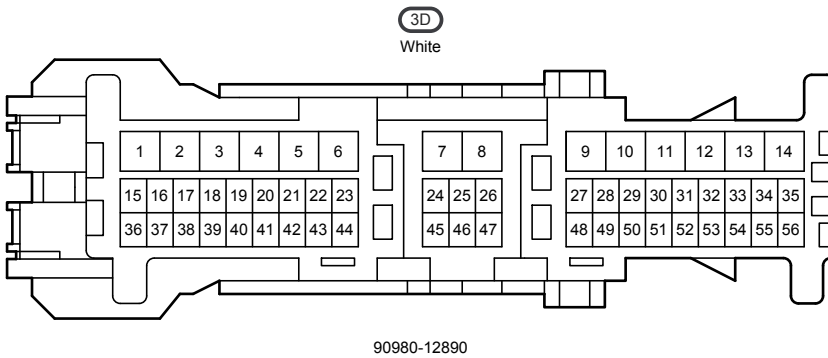
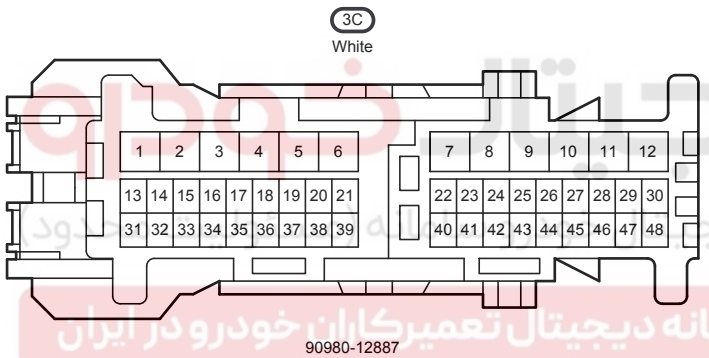
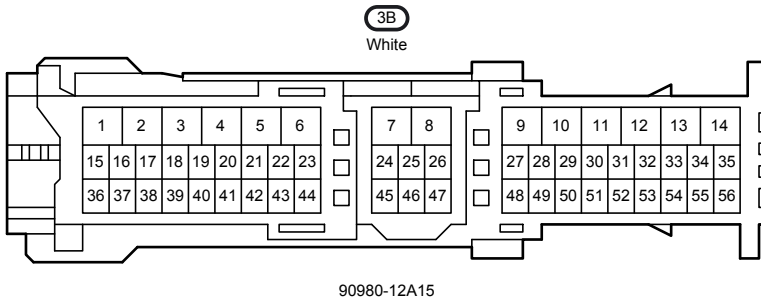
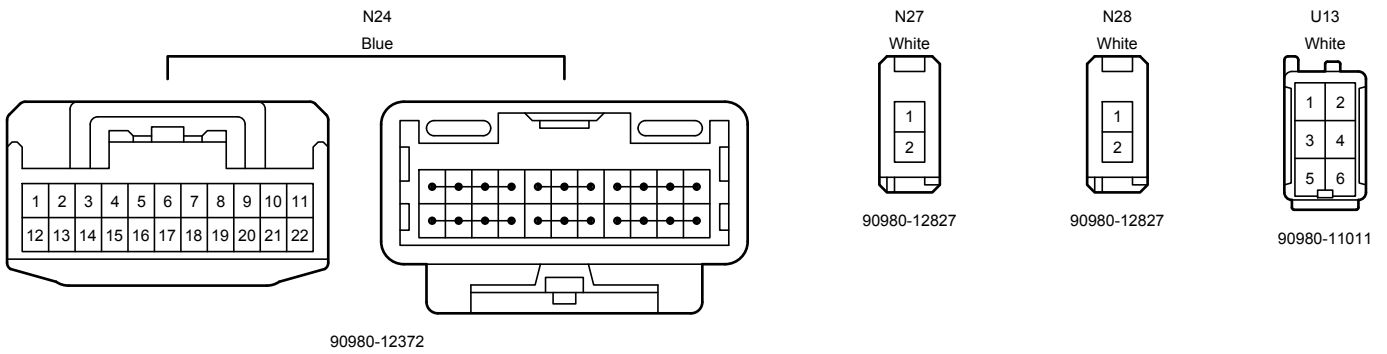

Door Lock Control (Korea) (Before Oct. 2015 Production)

3E

White

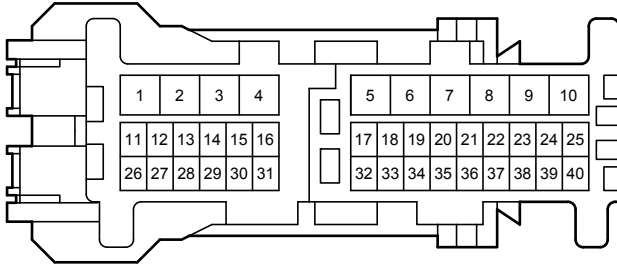

90980-12884

AN2

White

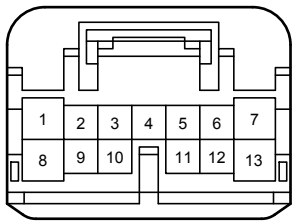

90980-12767

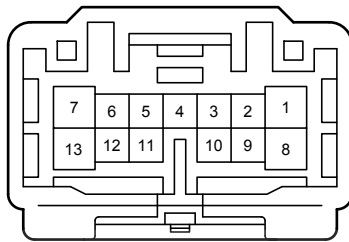

90980-12766

BA1

Blue

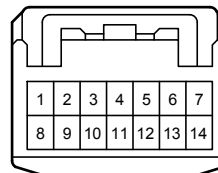

90980-12370

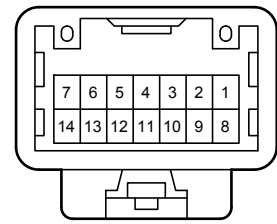

90980-12369

GM1

White

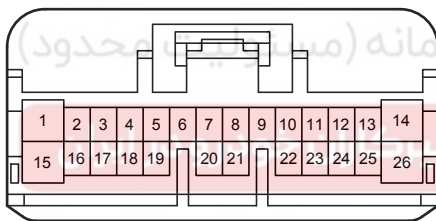

90980-12771

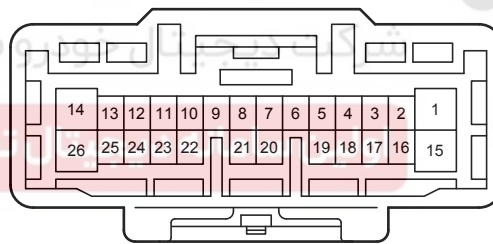

90980-12770

GM2

Blue

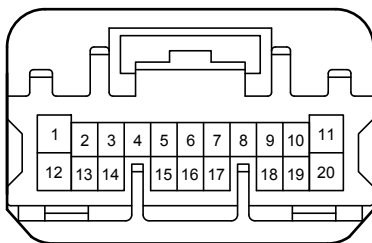

90980-12741

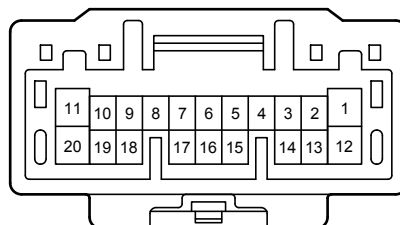

90980-12740

GM5

White

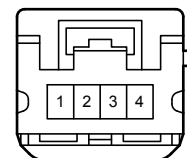

90980-12733

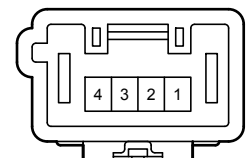

90980-12732

Door Lock Control (Korea) (Before Oct. 2015 Production)

GN2  
Blue

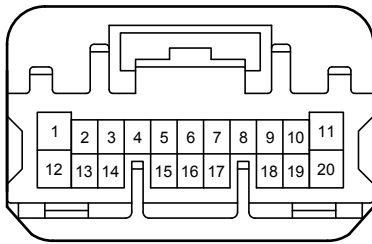

90980-12741

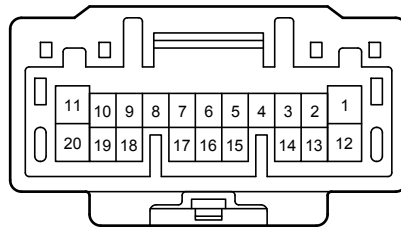

90980-12740

GN3  
White

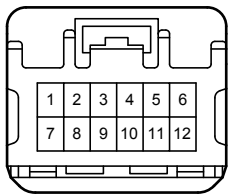

90980-12737

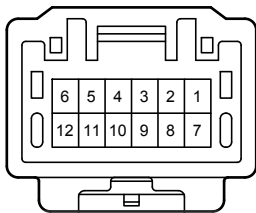

90980-12736

IG1  
White

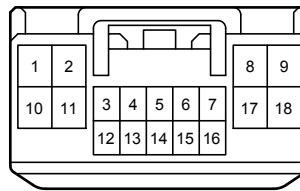

90980-12A21

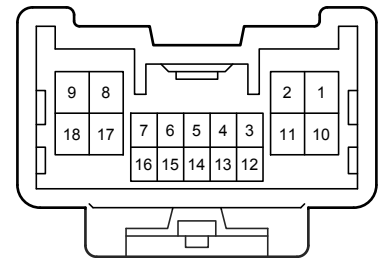

90980-12546

IG2  
White

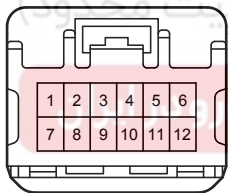

90980-12737

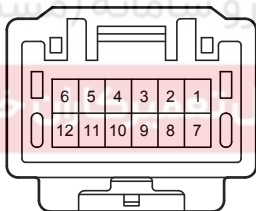

90980-12736

JG1  
White

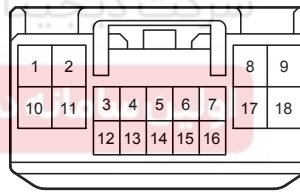

90980-12A21

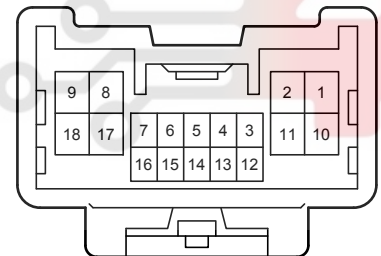

90980-12546

JG2  
White

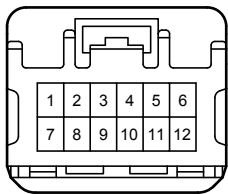

90980-12737

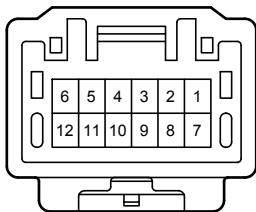

90980-12736

Door Lock Control (Korea) (Before Oct. 2015 Production)

KM1  
White

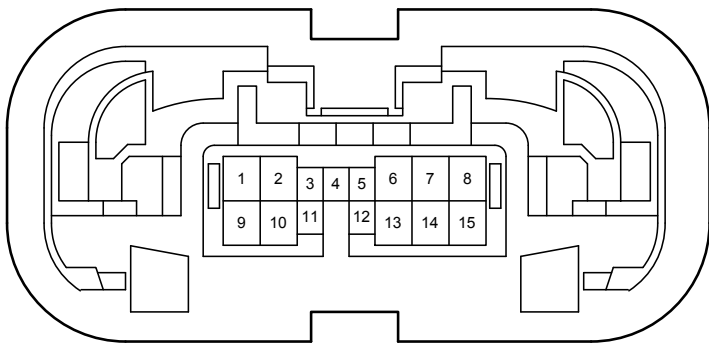

90980-12A01

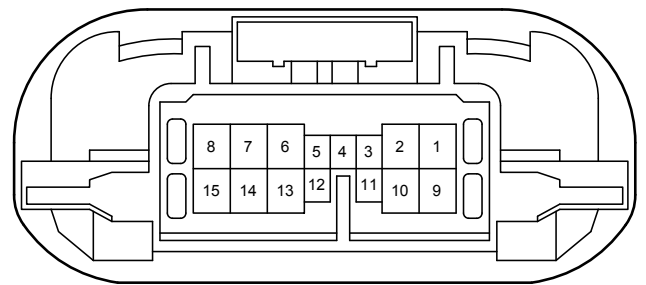

90980-12A00

LN1  
White

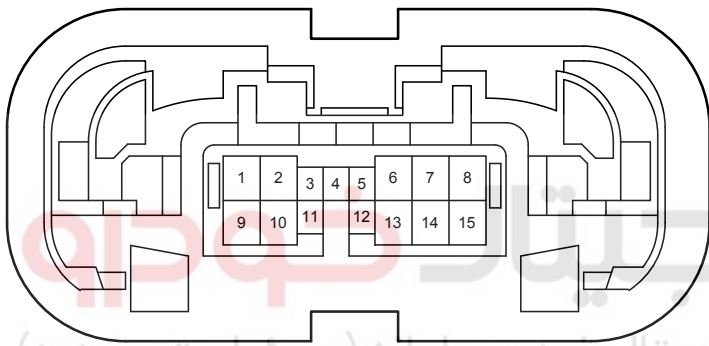

90980-12A01

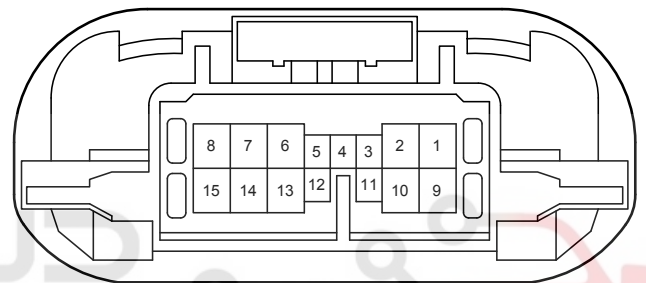

90980-12A00

شرکت دیجیتال خودرو سامانه (مسئولیت محدود)

اولین سامانه دیجیتال تعمیرگاه خودرو در ایران

UN2  
White

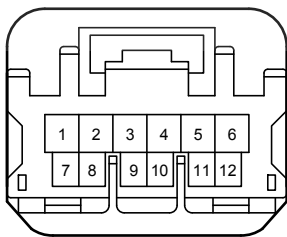

90980-12814

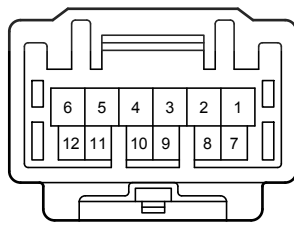

90980-12813

Door Lock Control (Except Korea) (Before Oct. 2015 Production)

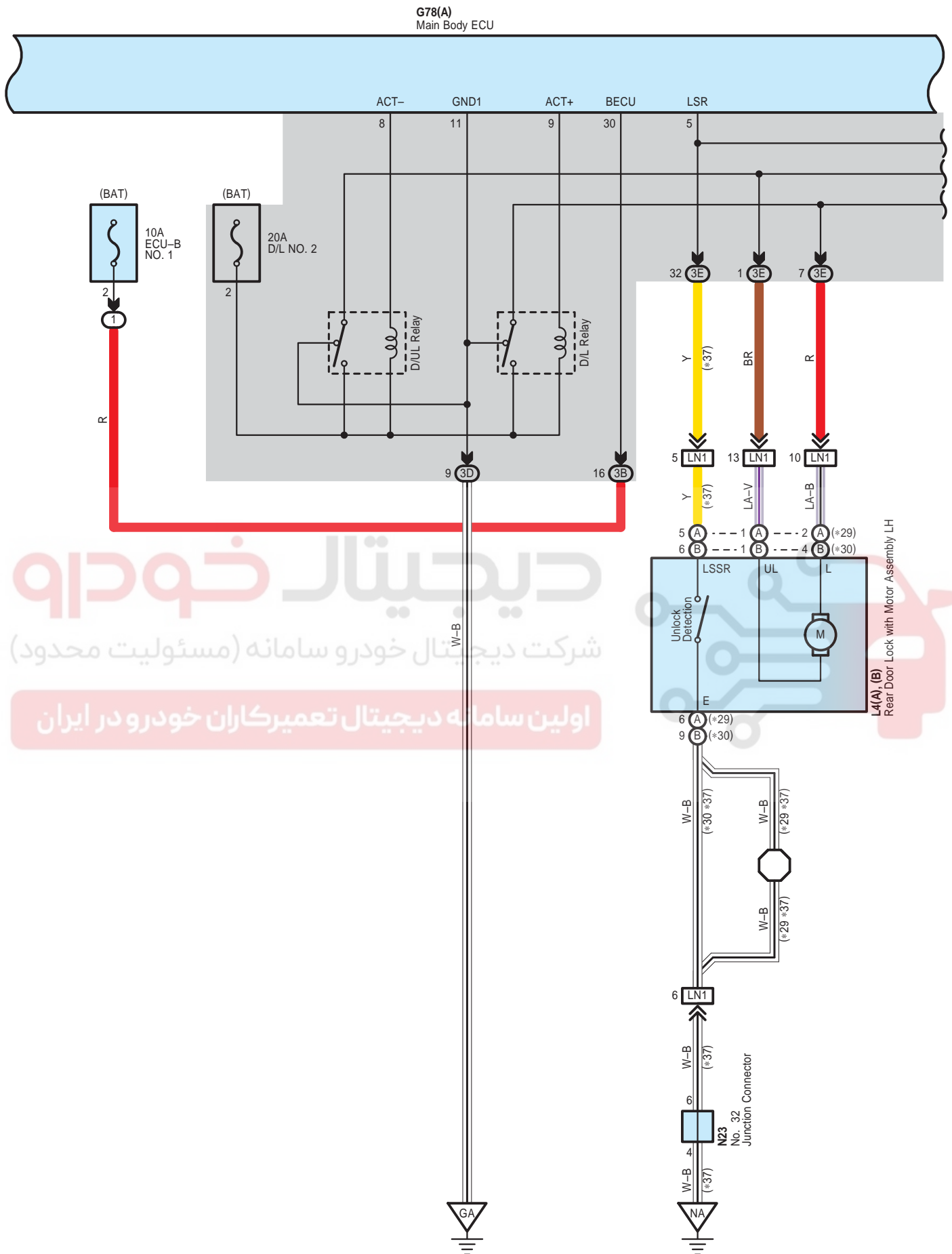

دیجیتال خودرو  
شرکت دیجیتال خودرو سامانه (مسئولیت محدود)  
اولین سامانه دیجیتال تعمیرکاران خودرو در ایران

Door Lock Control (Except Korea) (Before Oct. 2015 Production)

G78(A)  
Main Body ECU

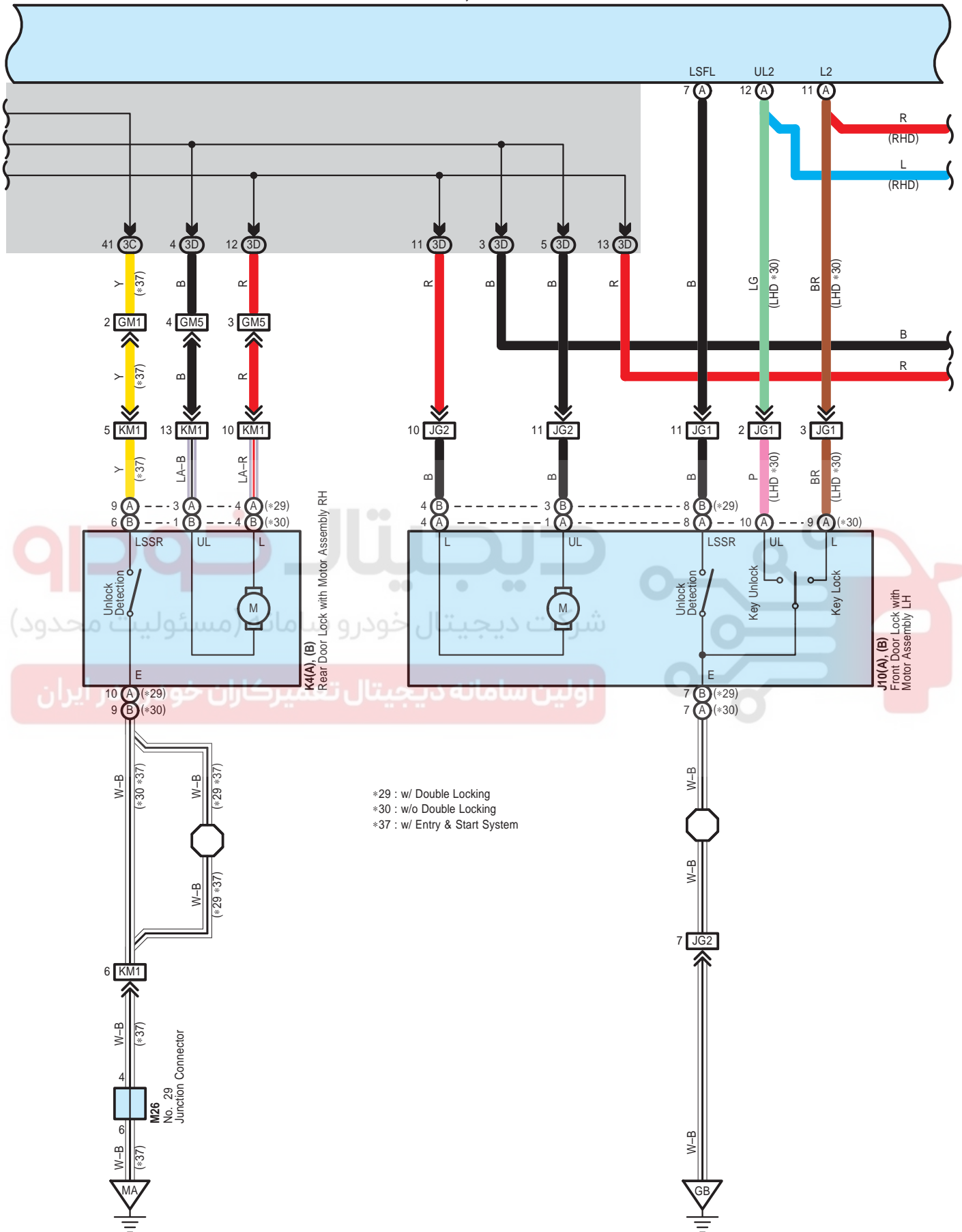

Door Lock Control (Except Korea) (Before Oct. 2015 Production)

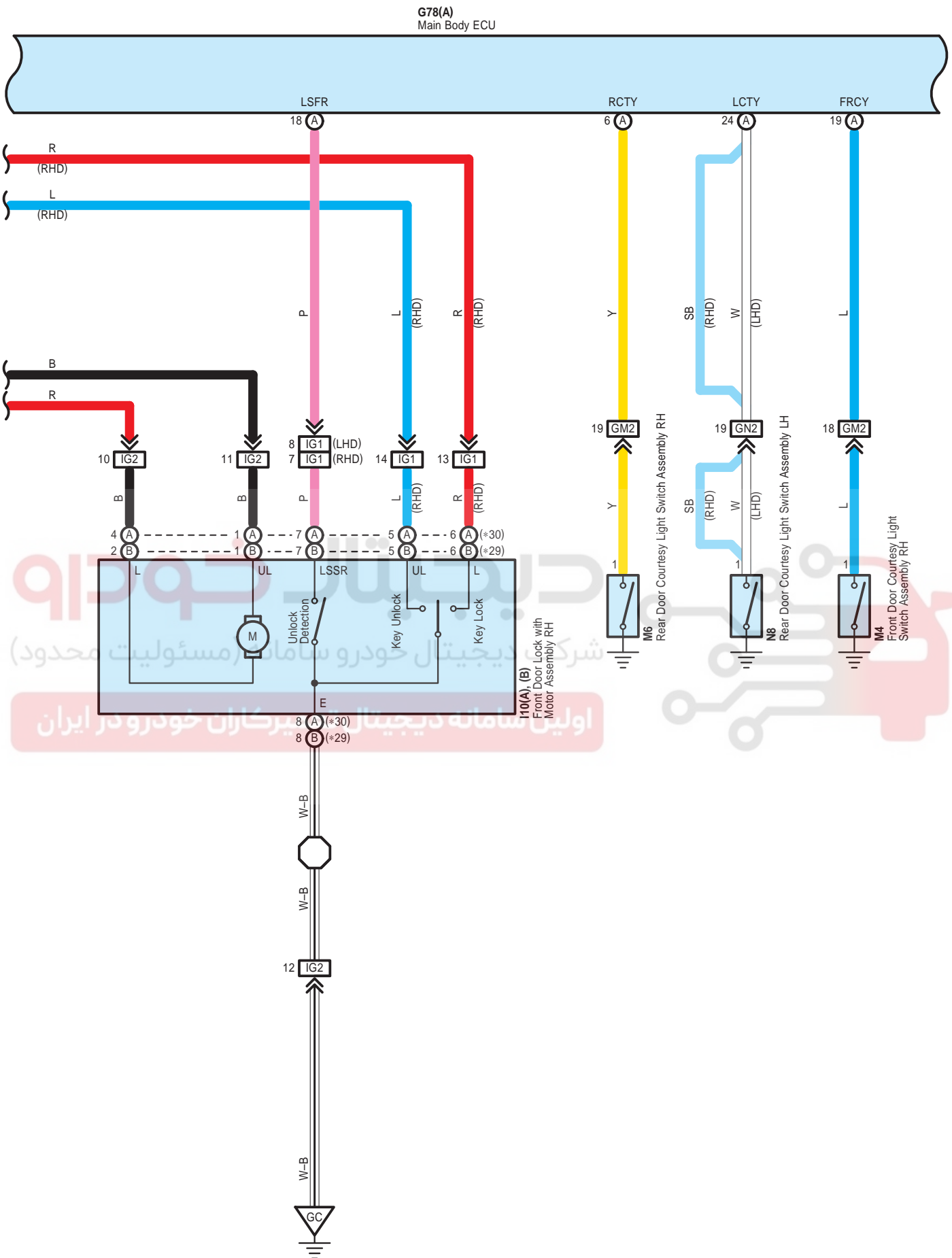





Door Lock Control (Except Korea) (Before Oct. 2015 Production)

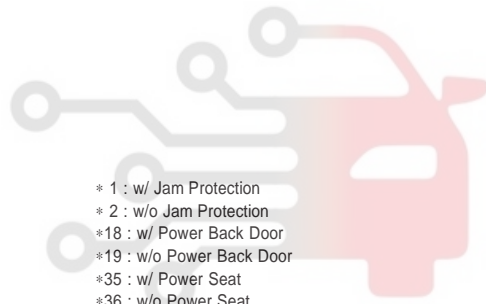
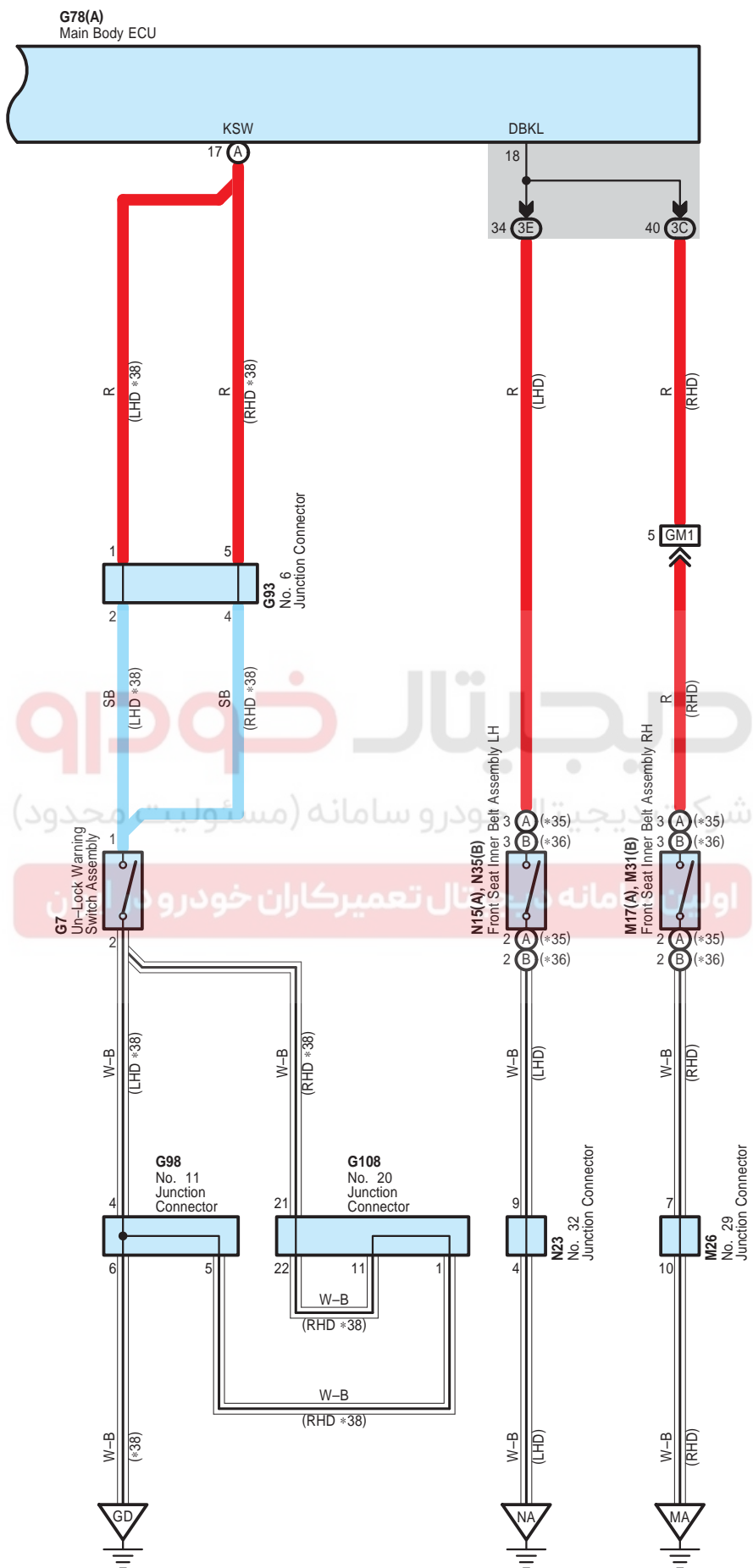

- \* 1 : w/ Jam Protection
- \* 2 : w/o Jam Protection
- \*18 : w/ Power Back Door
- \*19 : w/o Power Back Door
- \*35 : w/ Power Seat
- \*36 : w/o Power Seat
- \*38 : w/o Entry & Start System

Door Lock Control (Except Korea) (Before Oct. 2015 Production)

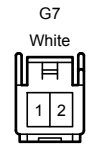

90980-12063

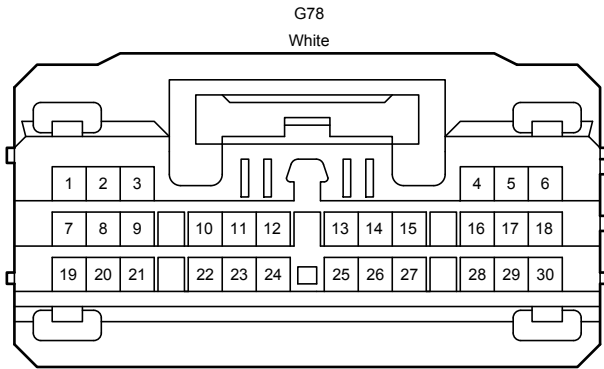

90980-12909

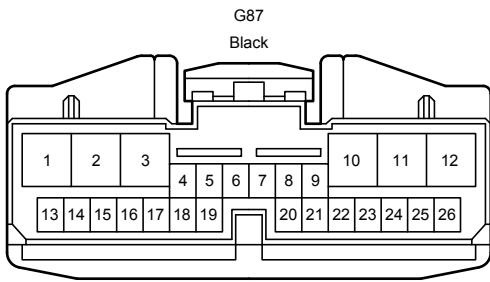

82824-12510

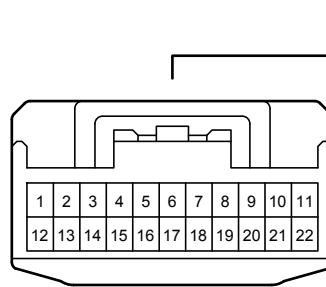

90980-12372

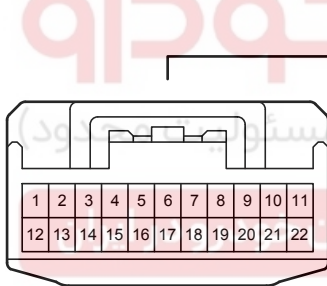
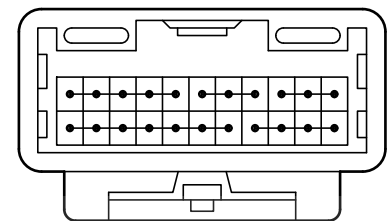

90980-12372

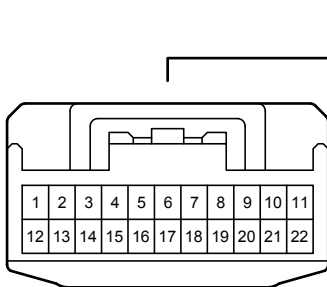
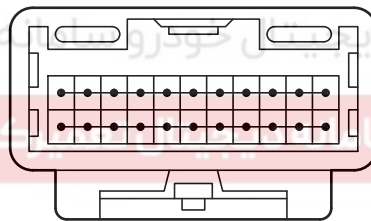

90980-12372

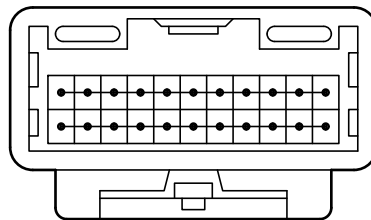

Door Lock Control (Except Korea) (Before Oct. 2015 Production)

G101  
White

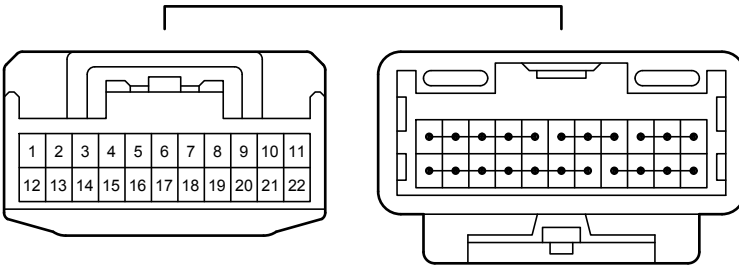

90980-12372

G108  
Gray

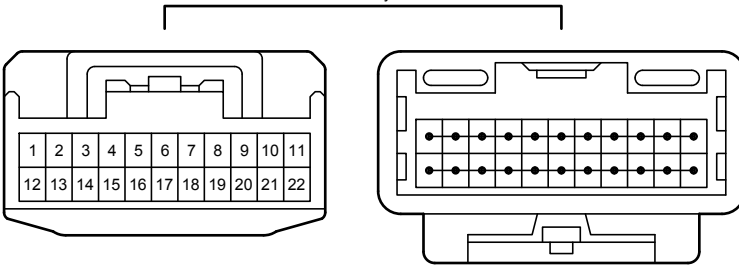

90980-12372

G109  
White

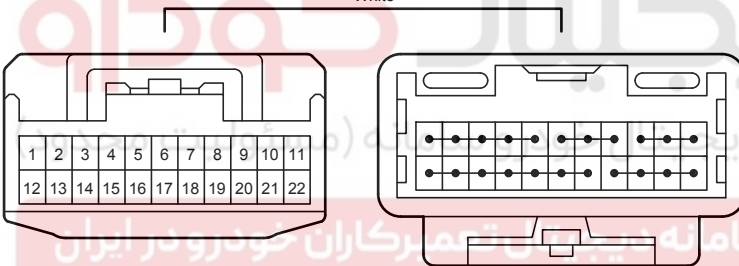

90980-12372

G151  
Gray

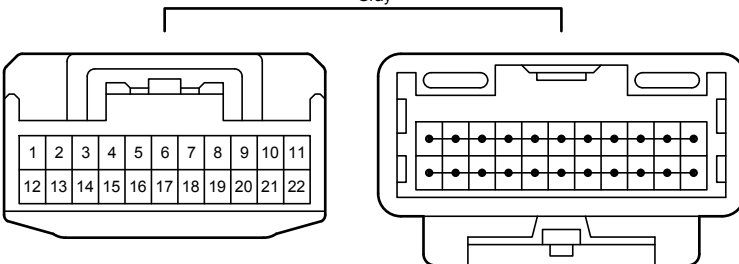

90980-12372

15  
White

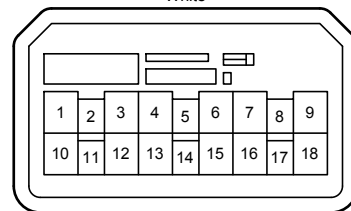

90980-12122

Door Lock Control (Except Korea) (Before Oct. 2015 Production)

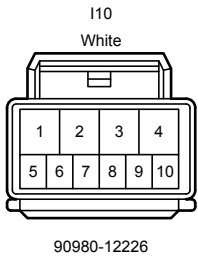

90980-12226

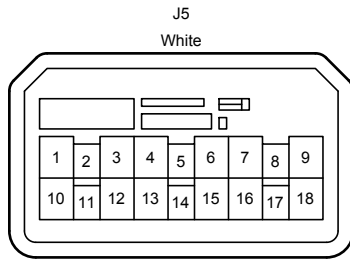

90980-12122

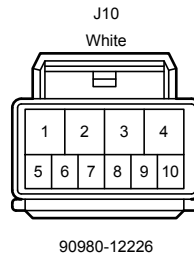

90980-12226

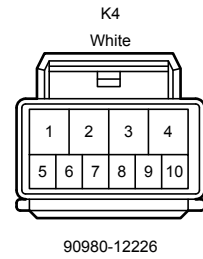

90980-12226

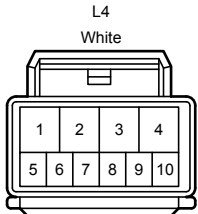

90980-12226

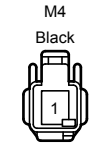

90980-10871



90980-10871

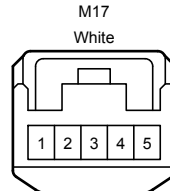

90980-12366

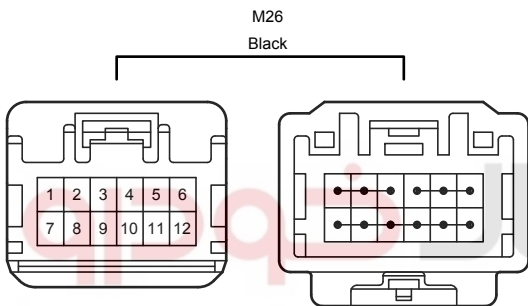

90980-12737

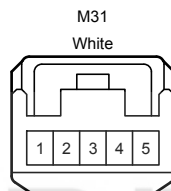

90980-12366

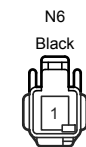

90980-10871

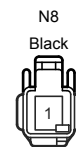

90980-10871

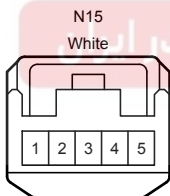

90980-12366

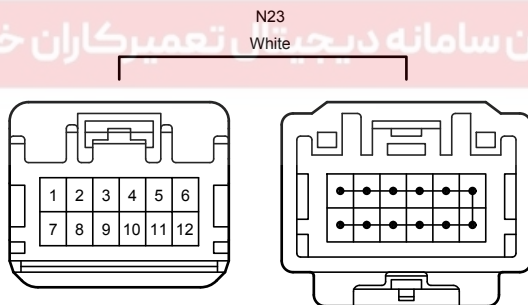

90980-12737

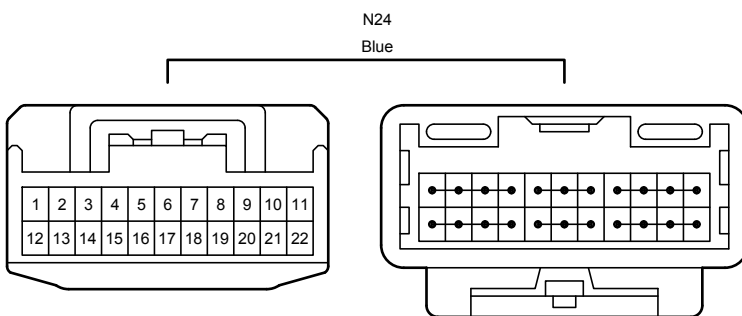

90980-12372

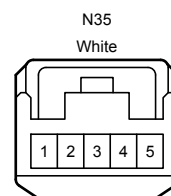

90980-12366

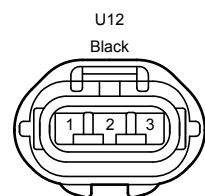

90980-11349

Door Lock Control (Except Korea) (Before Oct. 2015 Production)

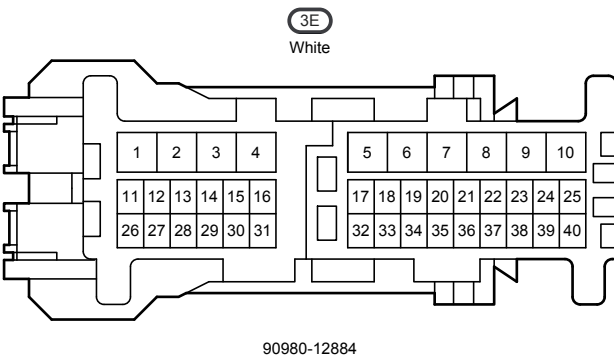
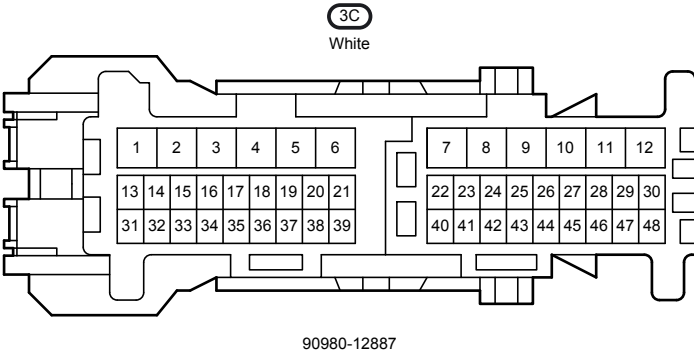
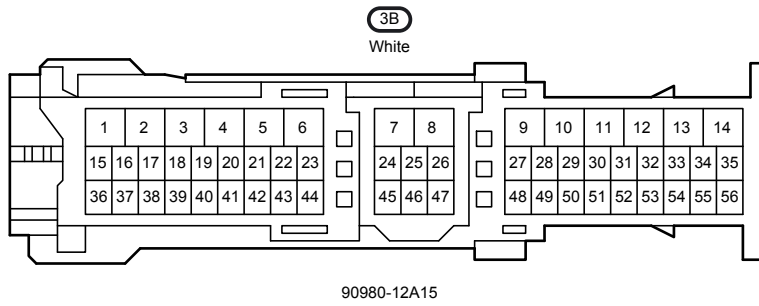
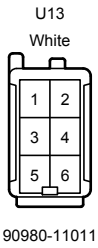

Door Lock Control (Except Korea) (Before Oct. 2015 Production)

GM1

White

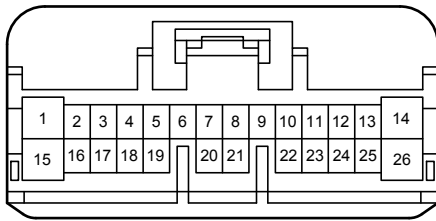

90980-12771

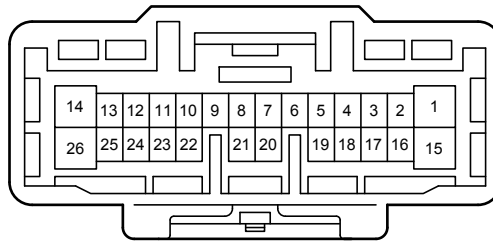

90980-12770

GM2

Blue

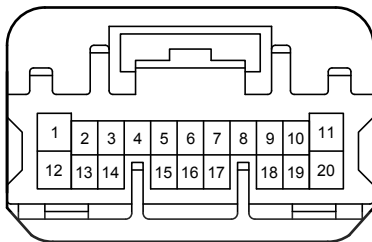

90980-12741

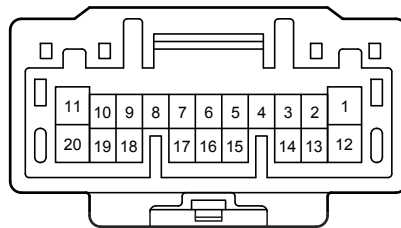

90980-12740

GM5

White

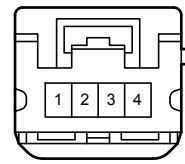

90980-12733

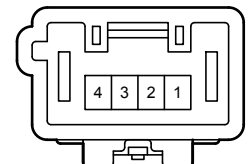

90980-12732

GN2

Blue

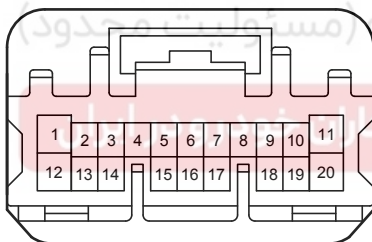

90980-12741

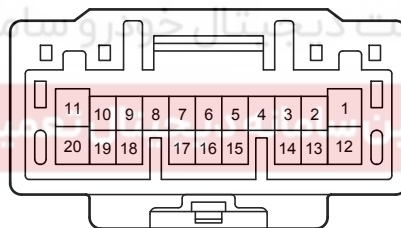

90980-12740

IG1

White

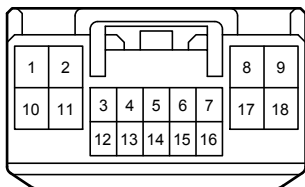

90980-12A21

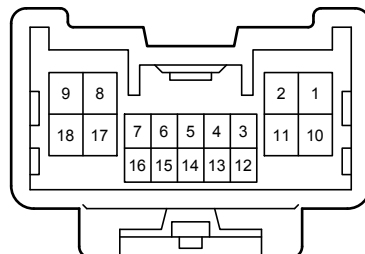

90980-12546

IG2

White

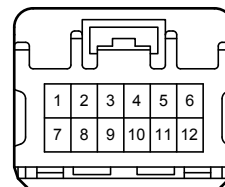

90980-12737

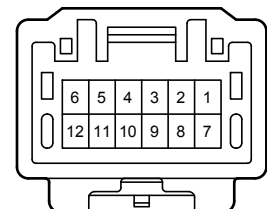

90980-12736

Door Lock Control (Except Korea) (Before Oct. 2015 Production)

JG1  
White

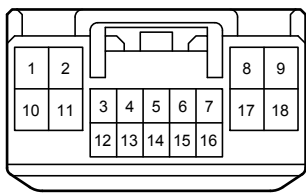

90980-12A21

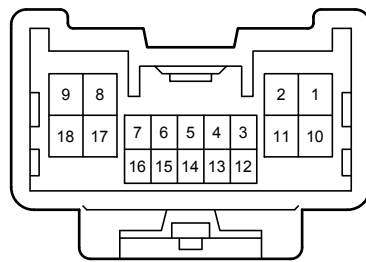

90980-12546

JG2  
White

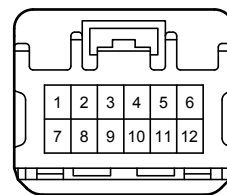

90980-12737

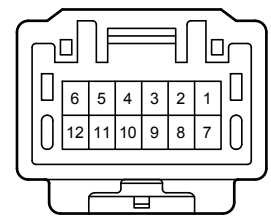

90980-12736

KM1  
White

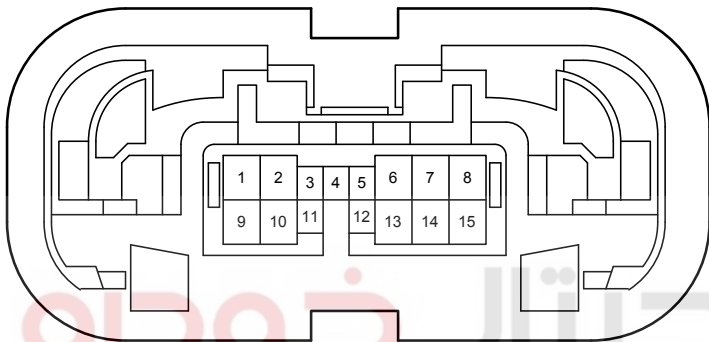

90980-12A01

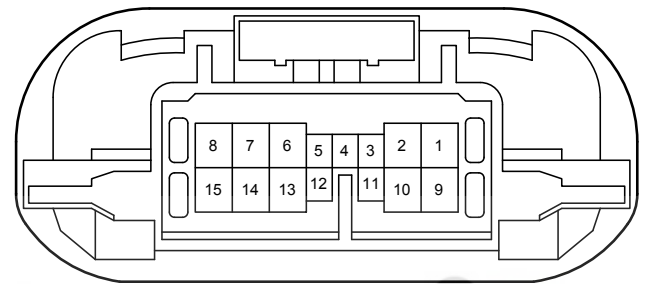

90980-12A00

LN1  
White

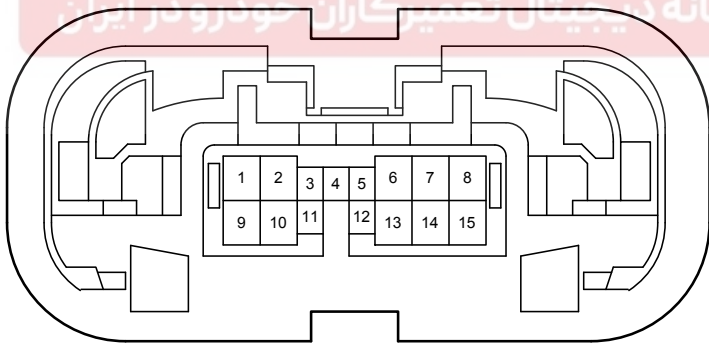

90980-12A01

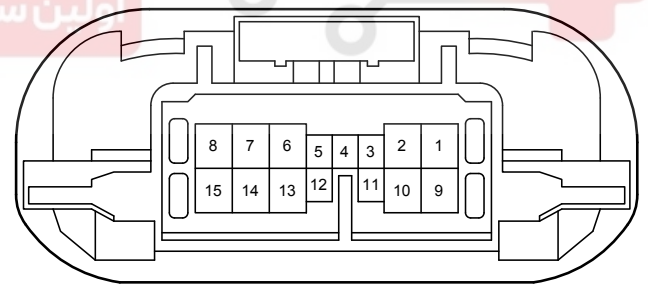

90980-12A00



Door Lock Control (Except Korea) (Before Oct. 2015 Production)

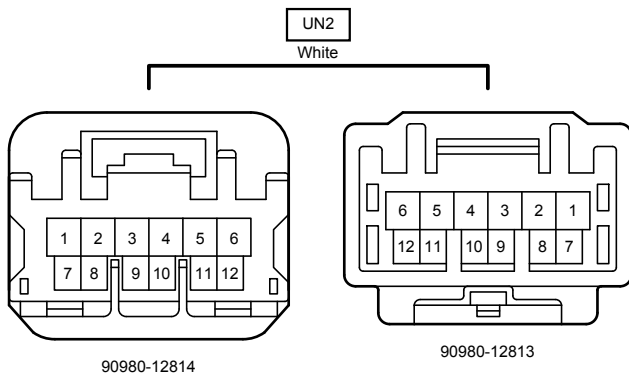

# دیجیتال خودرو

شرکت دیجیتال خودرو سامانه (مسئولیت محدود)

اولین سامانه دیجیتال تعمیرکاران خودرو در ایران

