

Blind Spot Monitor (Before Oct. 2015 Production)

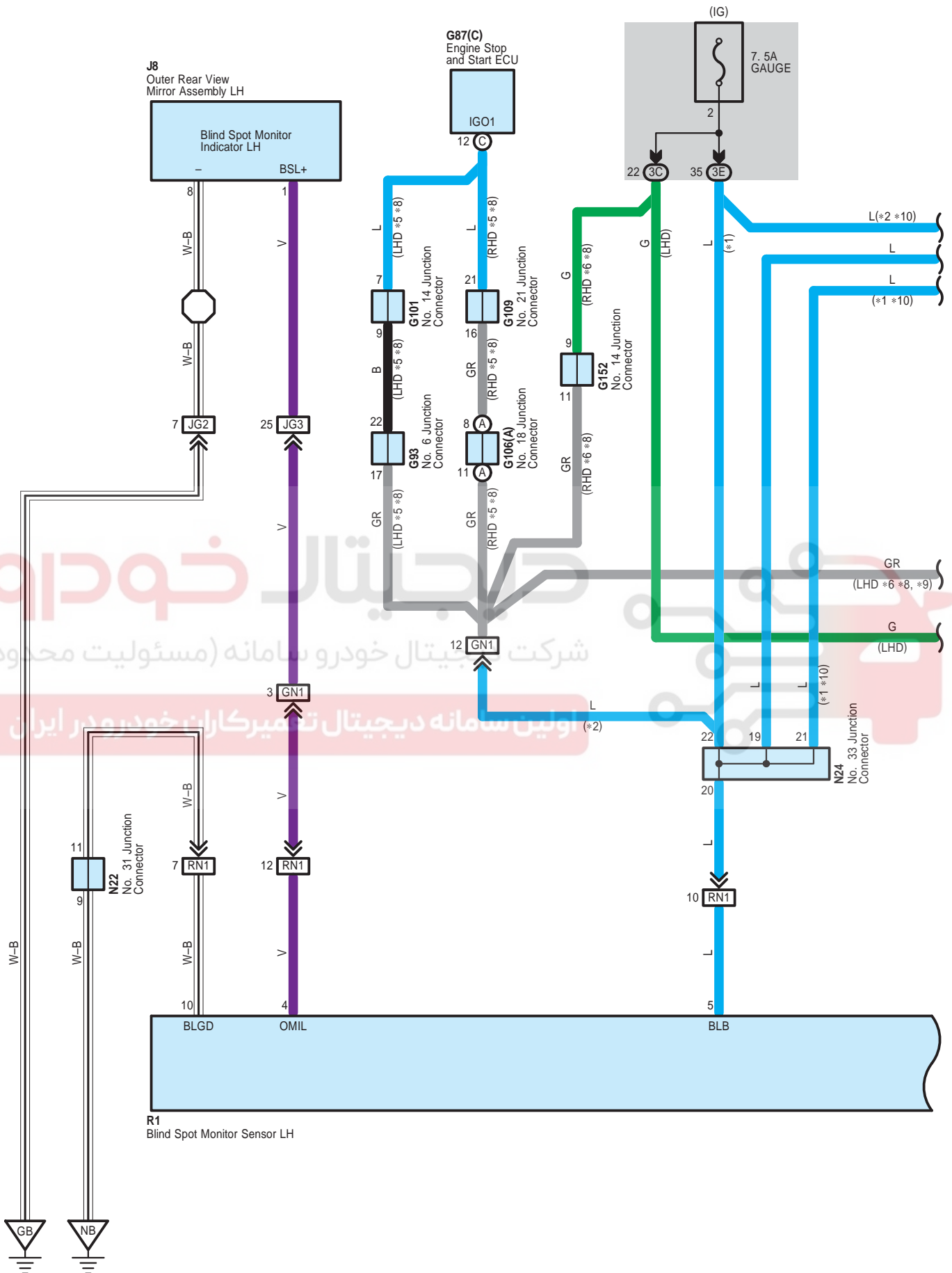

Blind Spot Monitor (Before Oct. 2015 Production)

- * 1 : Before Oct. 2014 Production
- * 2 : From Oct. 2014 Production
- * 5 : w/ Stop & Start System
- * 6 : w/o Stop & Start System
- * 8 : From Apr. 2015 Production
- * 9 : From Oct. 2014 Production until Apr. 2015 Production
- *10 : w/ Rear Cross Traffic Alert Buzzer

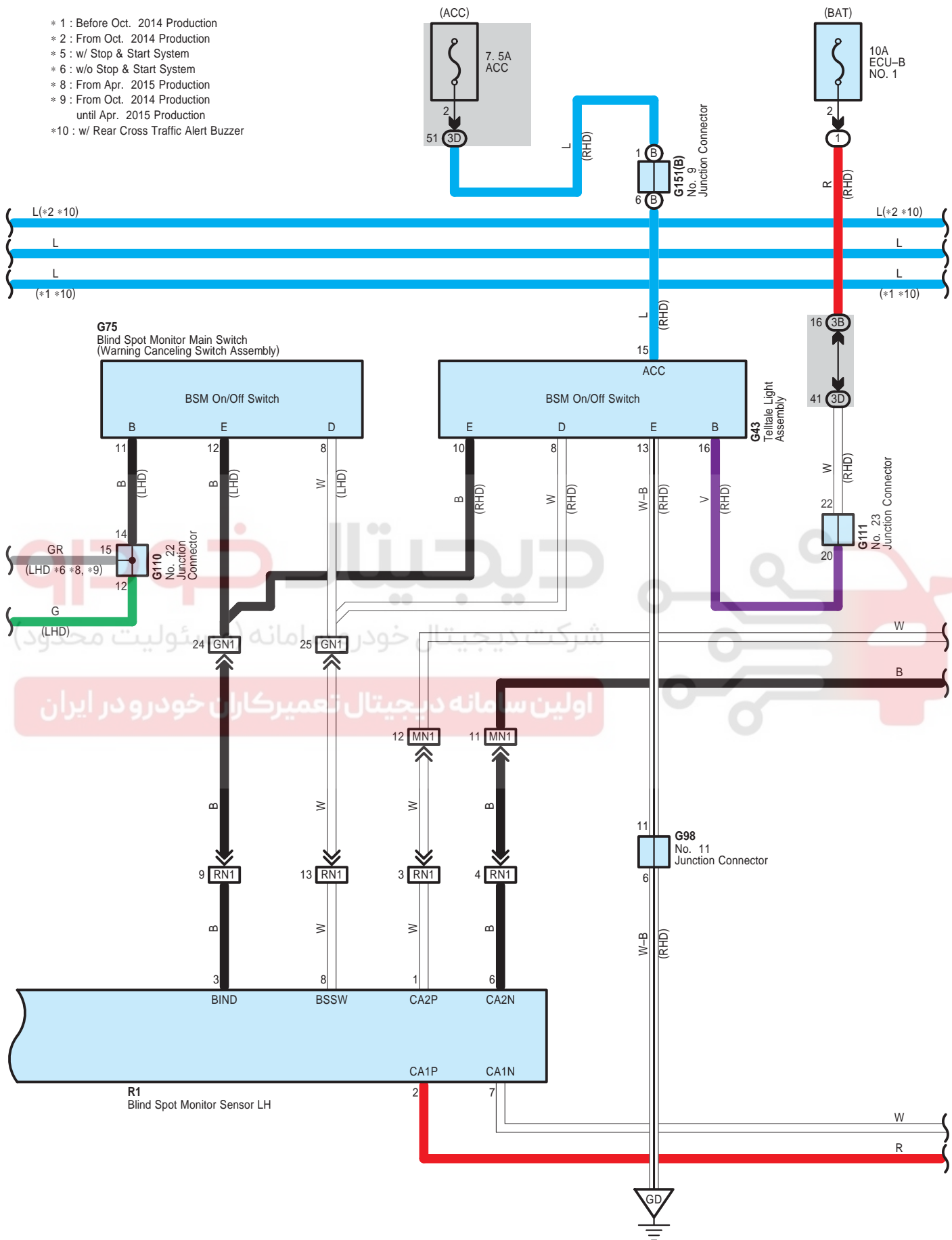

Blind Spot Monitor (Before Oct. 2015 Production)

- * 1 : Before Oct. 2014 Production
- * 2 : From Oct. 2014 Production
- *10 : w/ Rear Cross Traffic Alert Buzzer
- *11 : Except 2AR-FE
- *12 : 2AR-FE
- *13 : A/T, CVT
- *14 : M/T

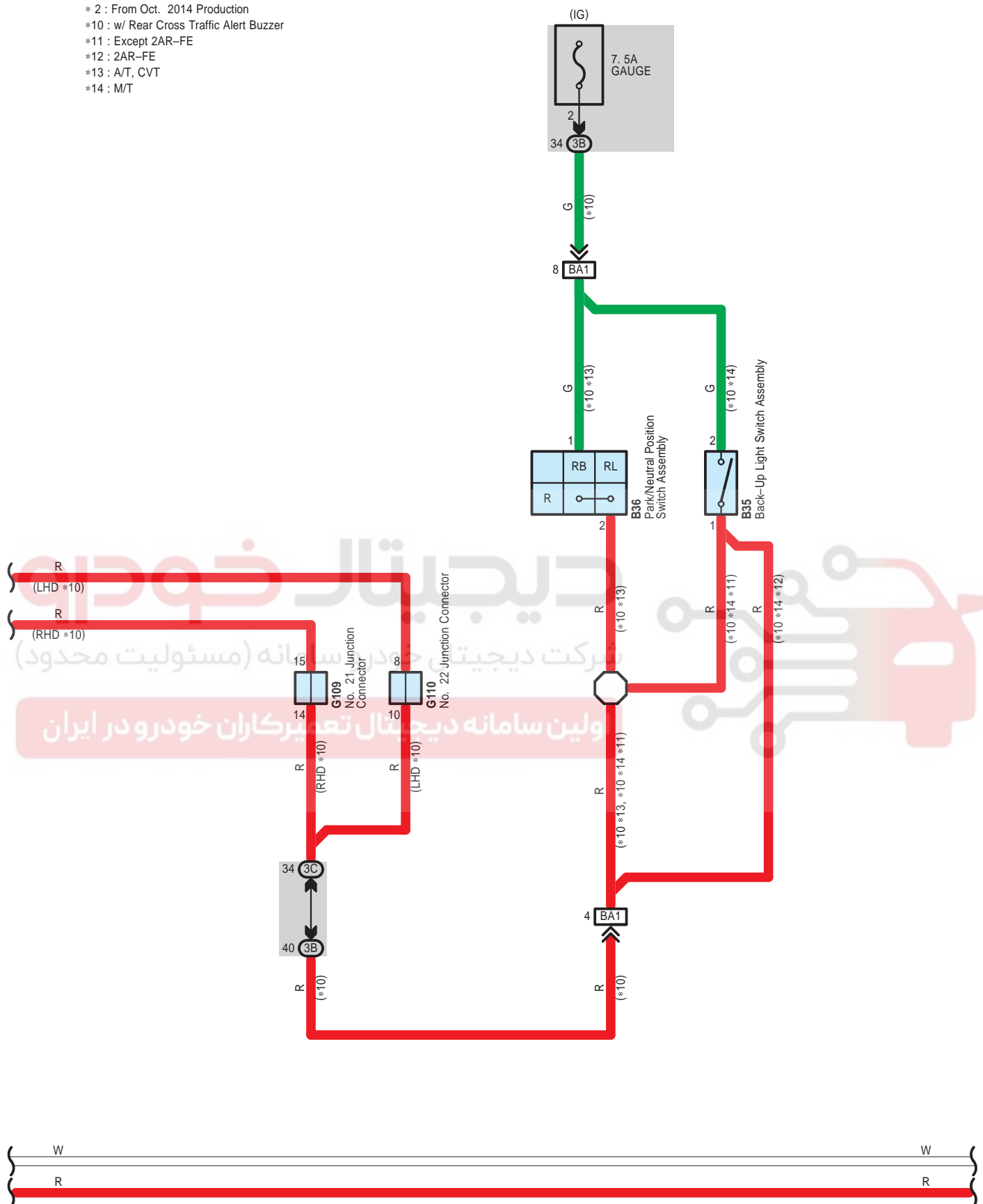

Blind Spot Monitor (Before Oct. 2015 Production)

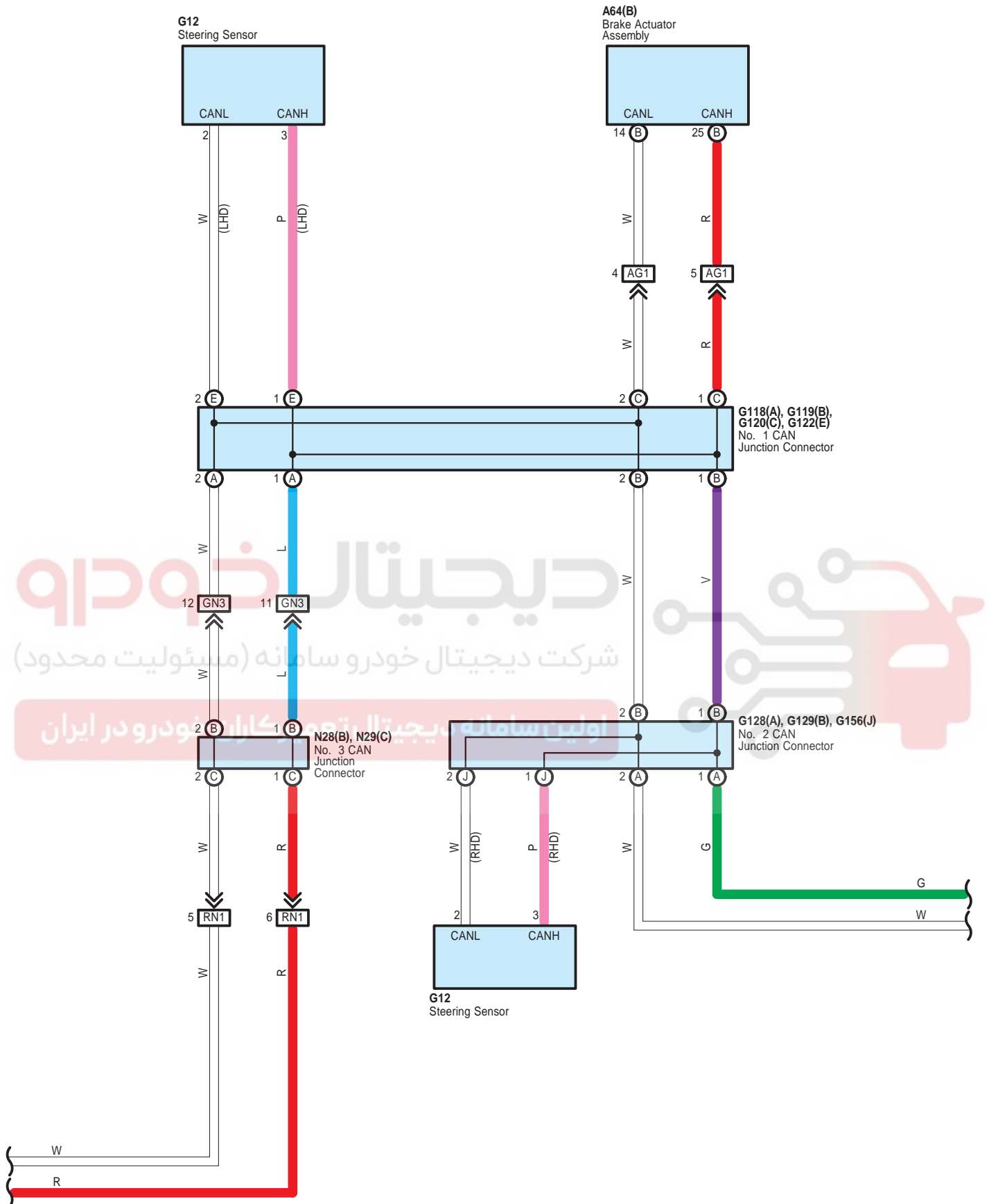

Blind Spot Monitor (Before Oct. 2015 Production)

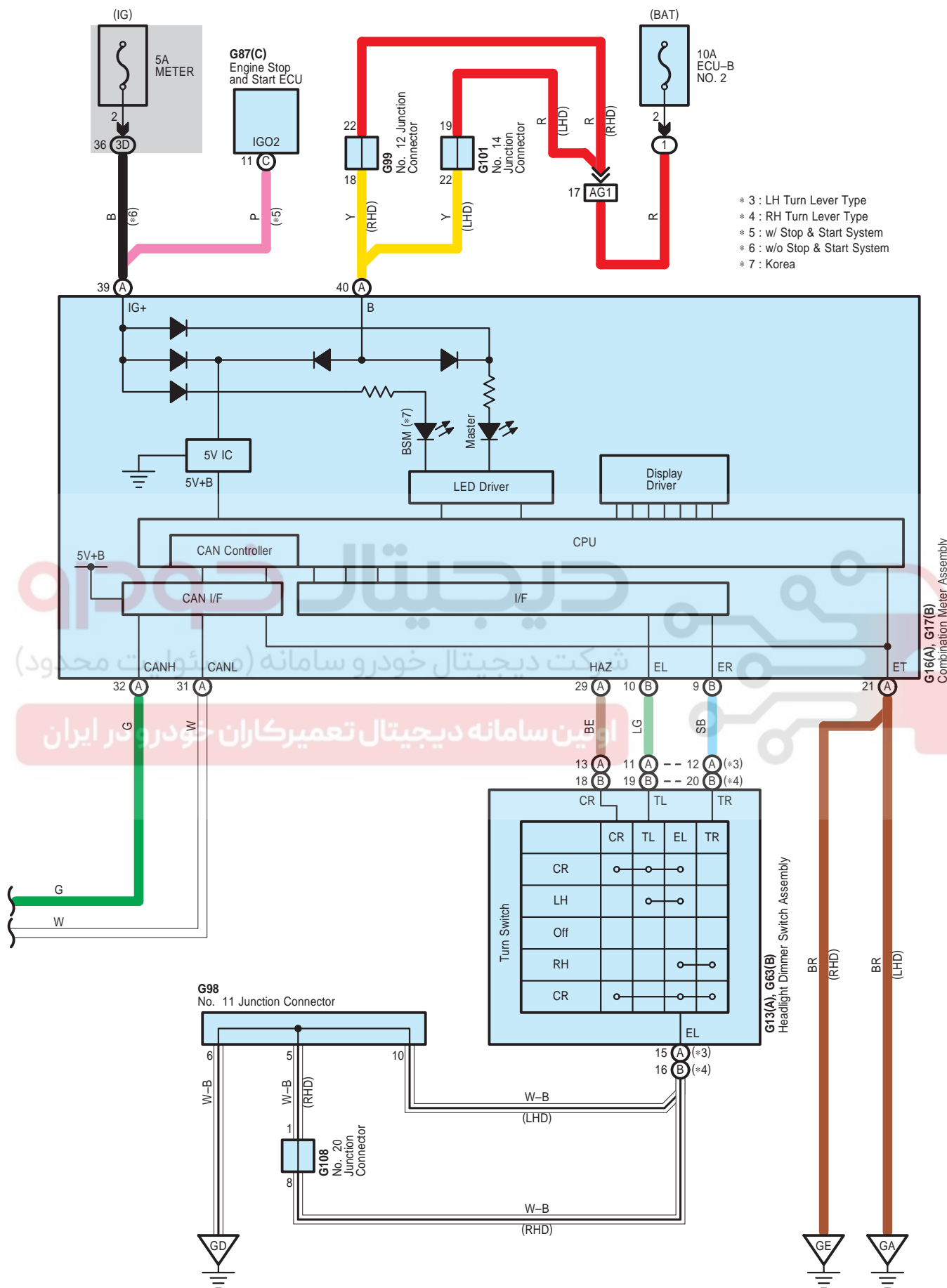

- * 3 : LH Turn Lever Type
- * 4 : RH Turn Lever Type
- * 5 : w/ Stop & Start System
- * 6 : w/o Stop & Start System
- * 7 : Korea

Blind Spot Monitor (Before Oct. 2015 Production)

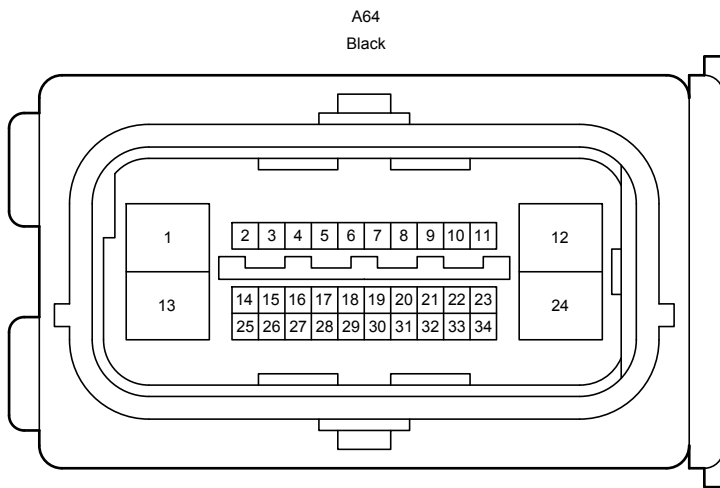

90980-12686

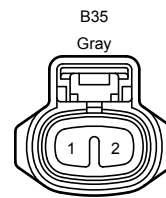

90980-11250

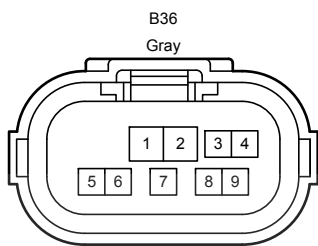

90980-12362

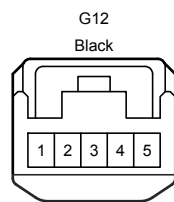

90980-12366

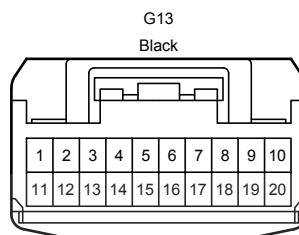

90980-12460

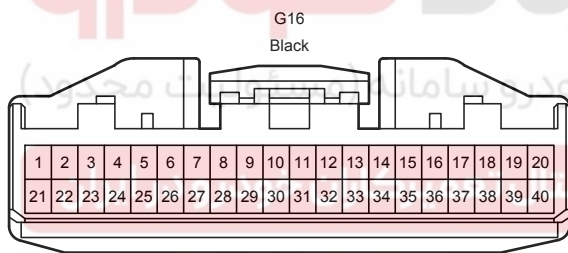

90980-12557

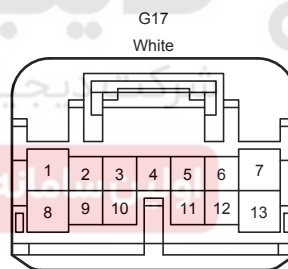

90980-12767

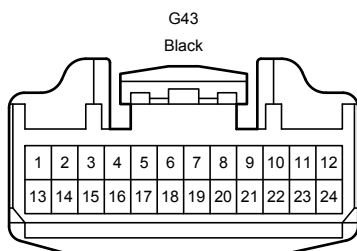

90980-12554

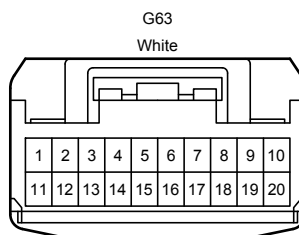

90980-12460

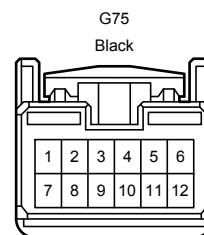

90980-12614

Blind Spot Monitor (Before Oct. 2015 Production)

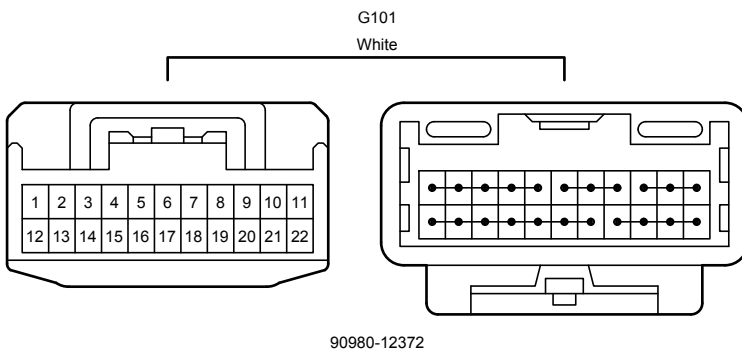
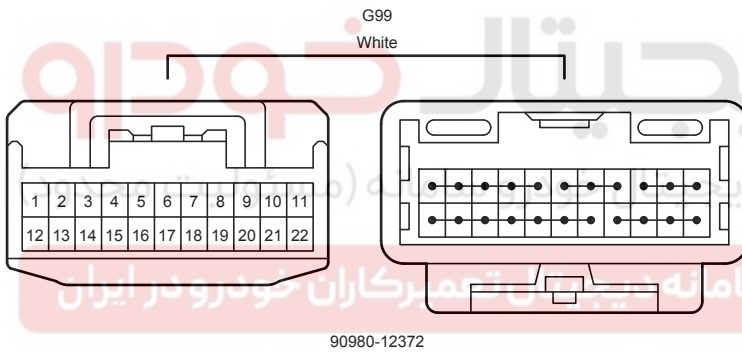
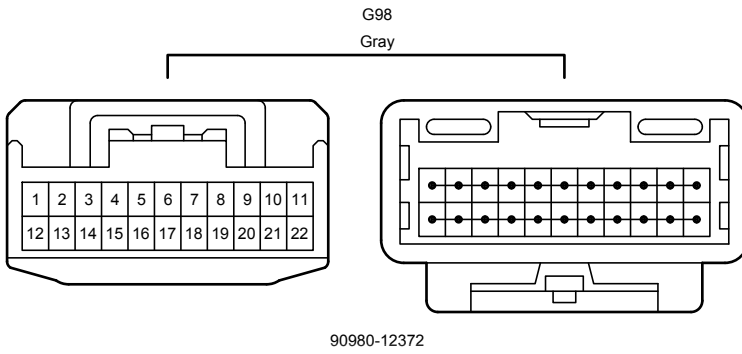
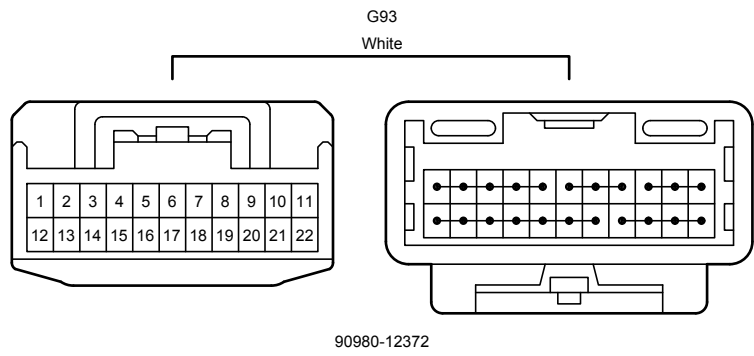
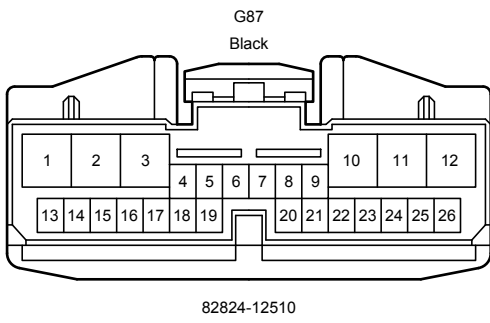

Blind Spot Monitor (Before Oct. 2015 Production)

G106
Blue

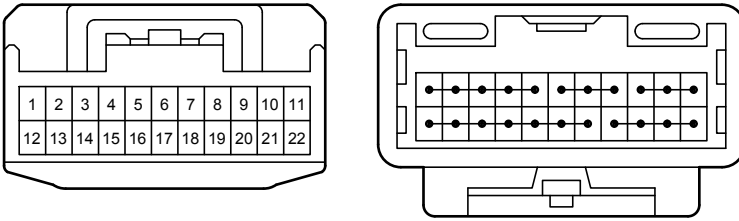

90980-12372

G108
Gray

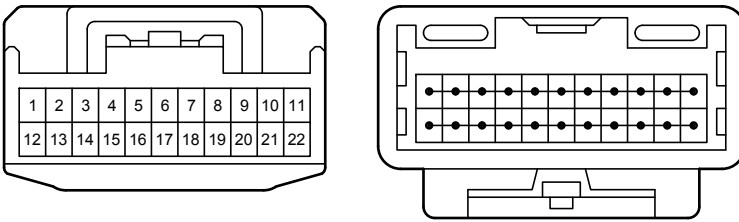

90980-12372

G109
White

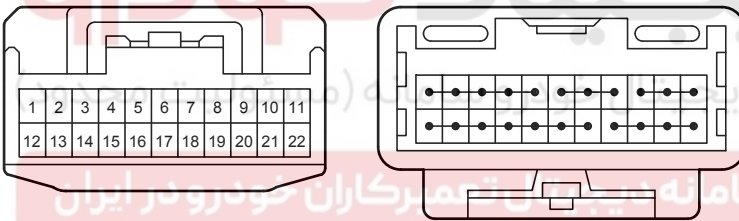

90980-12372

G110
Blue

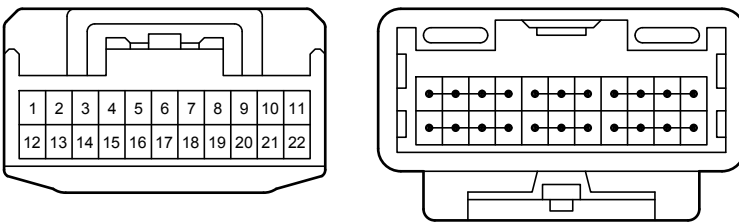

90980-12372



Blind Spot Monitor (Before Oct. 2015 Production)

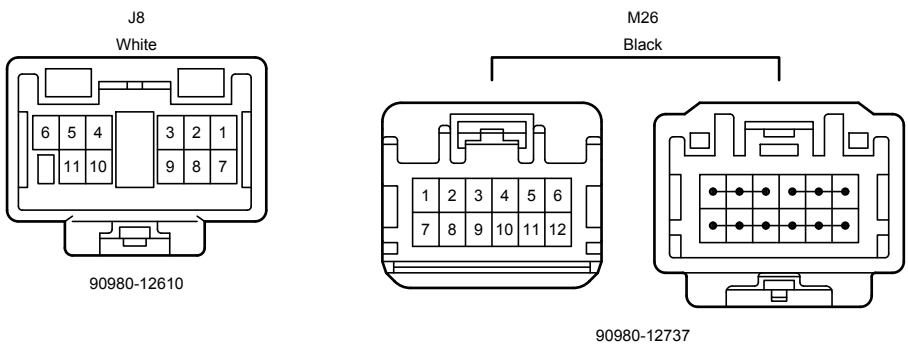
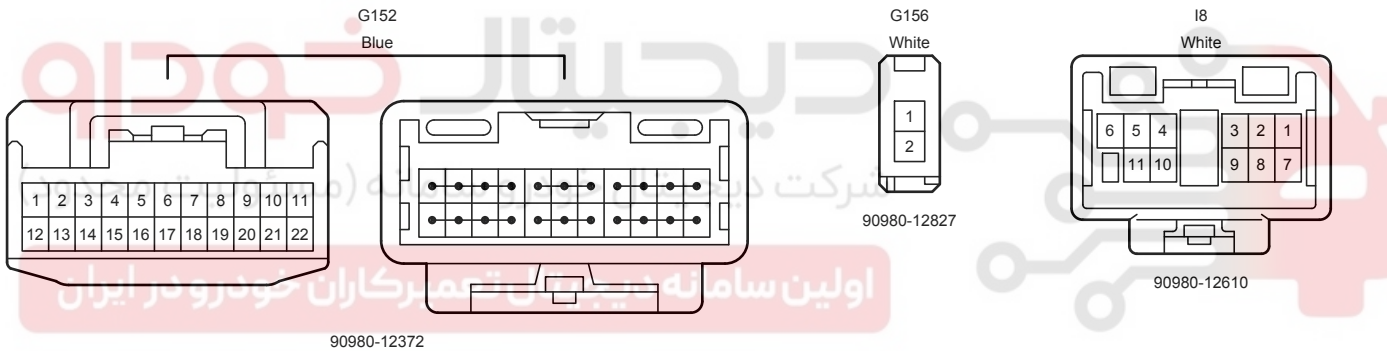
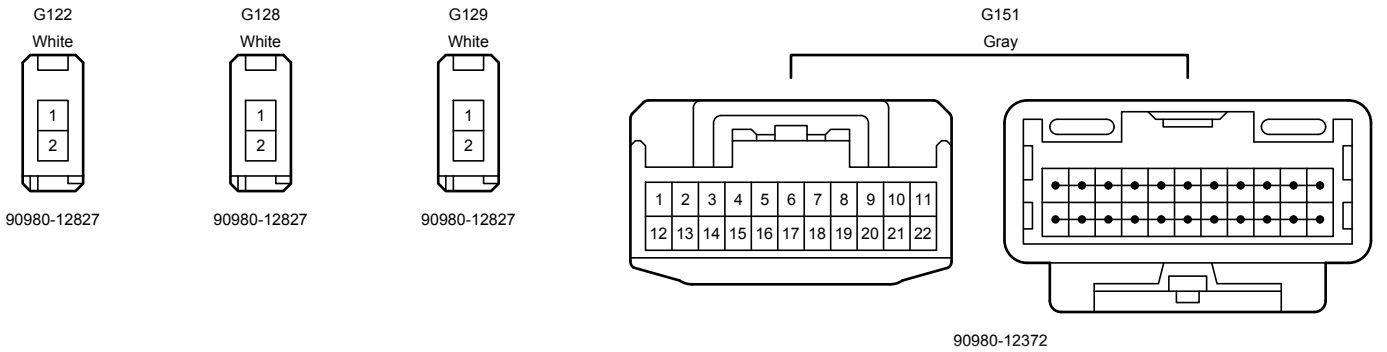
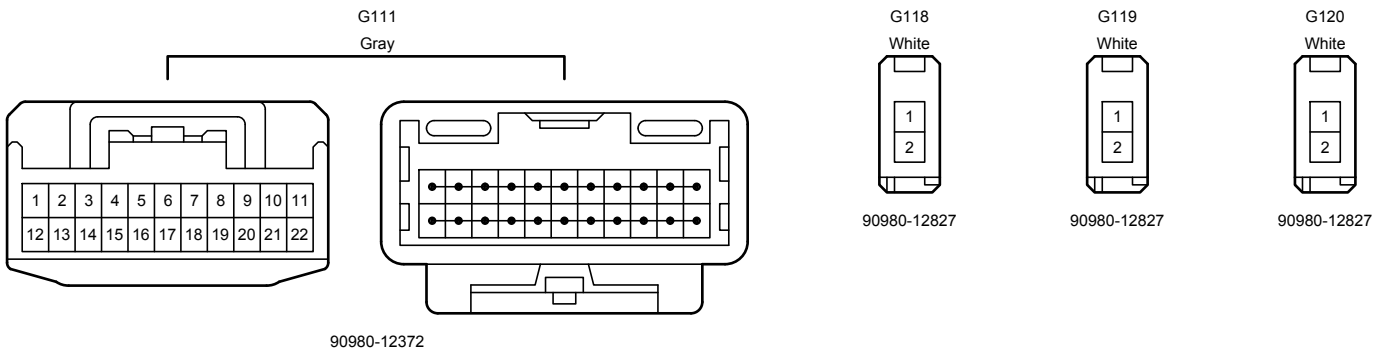

Blind Spot Monitor (Before Oct. 2015 Production)

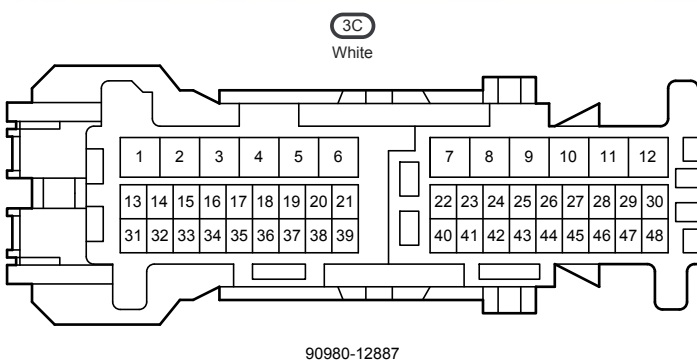
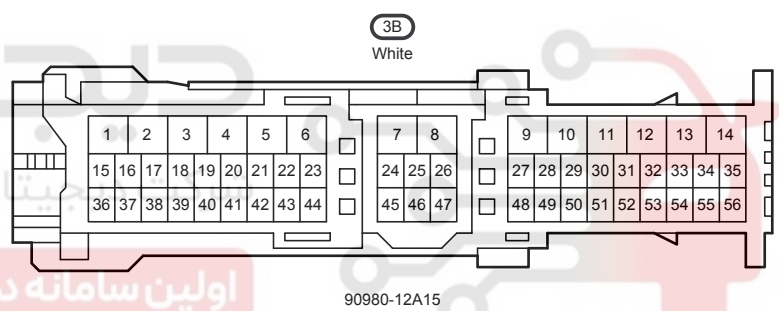
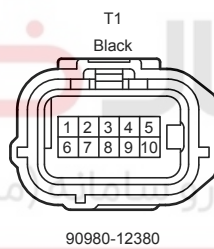
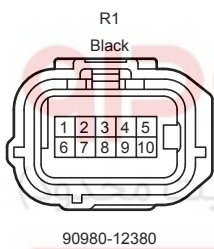
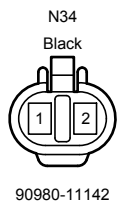
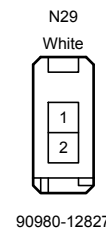
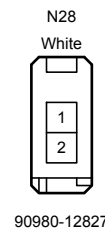
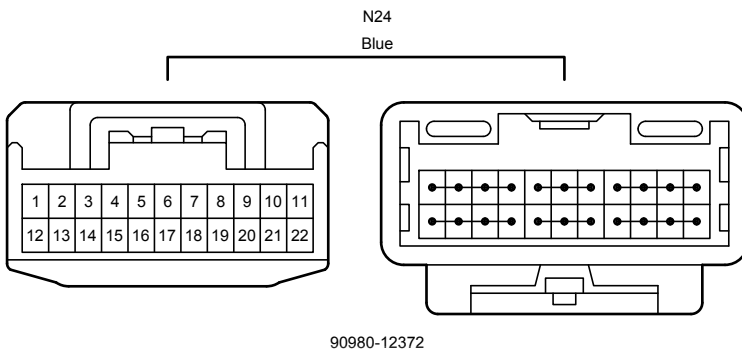
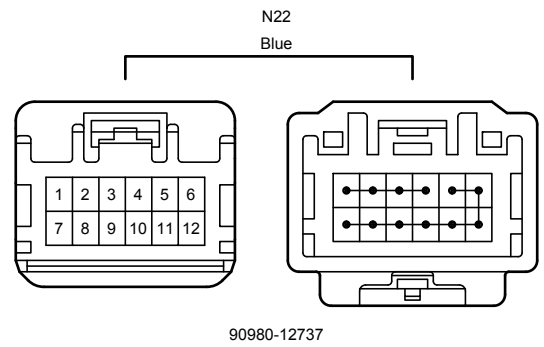
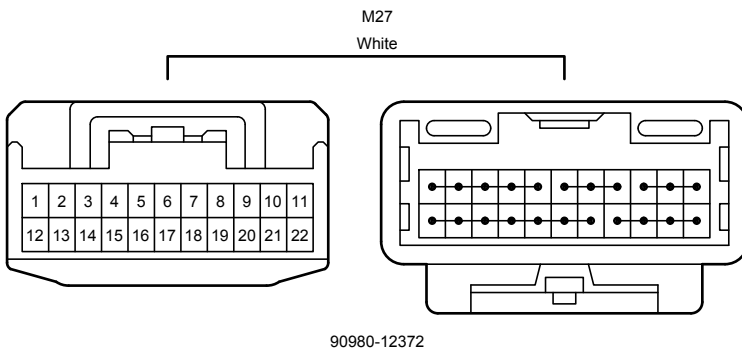

Blind Spot Monitor (Before Oct. 2015 Production)

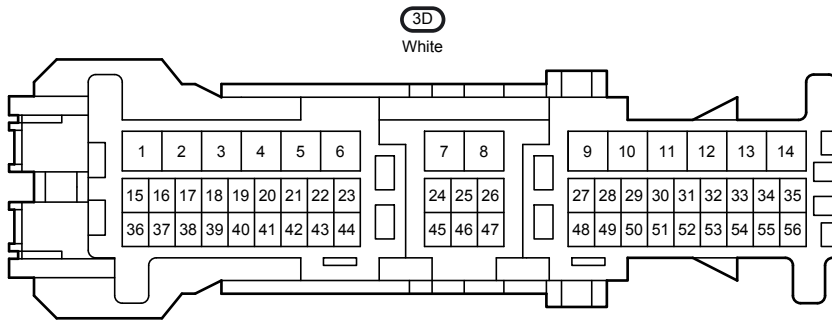

90980-12890

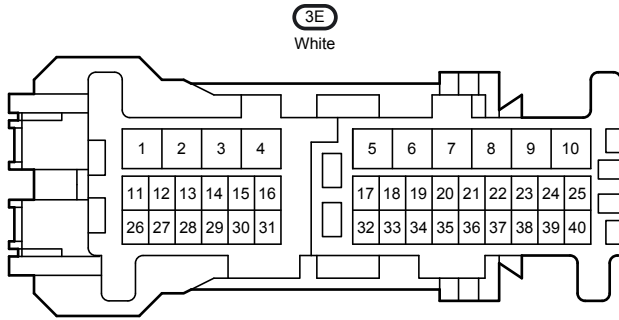

90980-12884



90980-12771

90980-12770

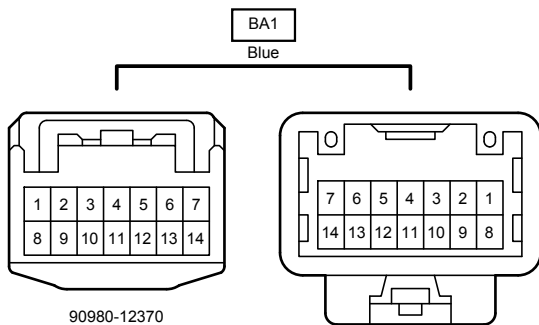

90980-12370

90980-12369

Blind Spot Monitor (Before Oct. 2015 Production)

GM1
White

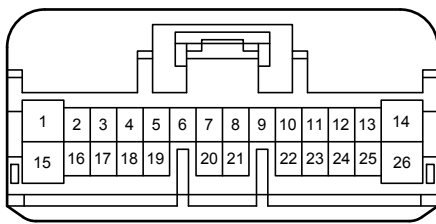

90980-12771

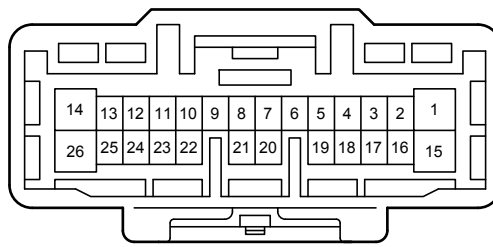

90980-12770

GN1
White

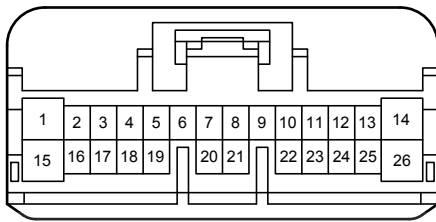

90980-12771

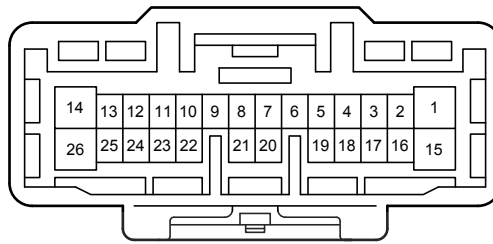

90980-12770

GN3
White

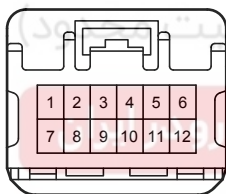

90980-12737

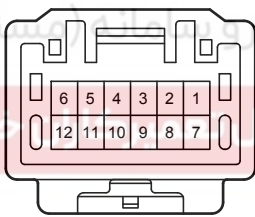

90980-12736

IG1
White

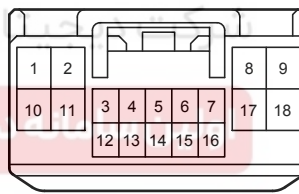

90980-12A21

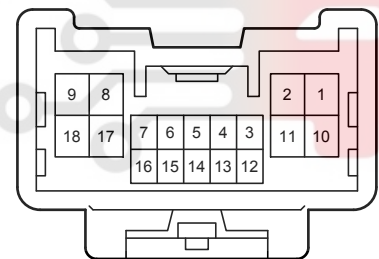

90980-12546

IG2
White

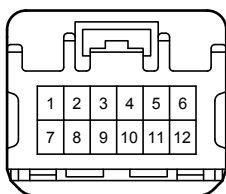

90980-12737

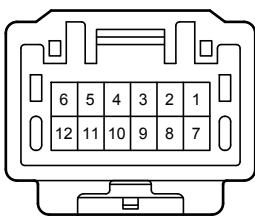

90980-12736

JG2
White

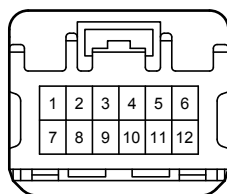

90980-12737

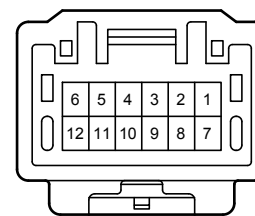

90980-12736

Blind Spot Monitor (Before Oct. 2015 Production)

JG3
Black

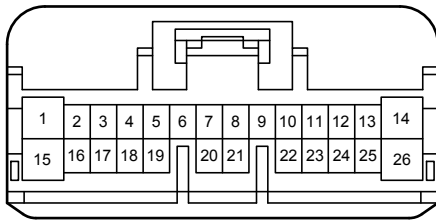

90980-12771

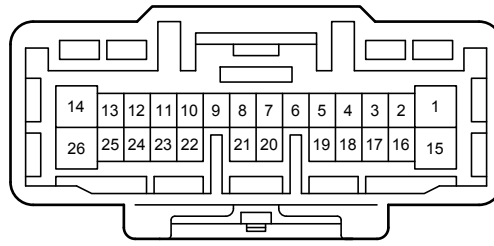

90980-12770

MN1
White

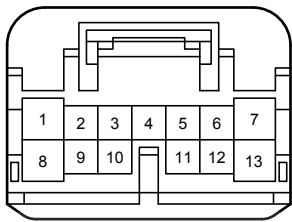

90980-12767

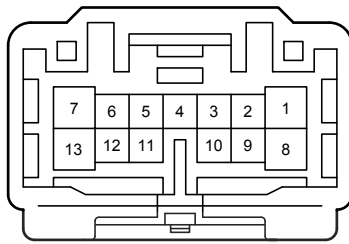

90980-12766

RN1
White

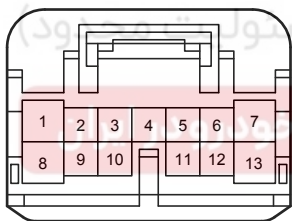

90980-12767

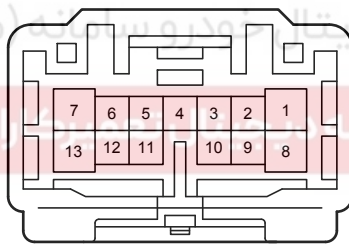

90980-12766

TM1
White

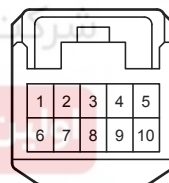

90980-12368

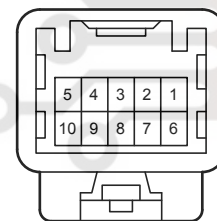

90980-12367