

EMS Sensor 1

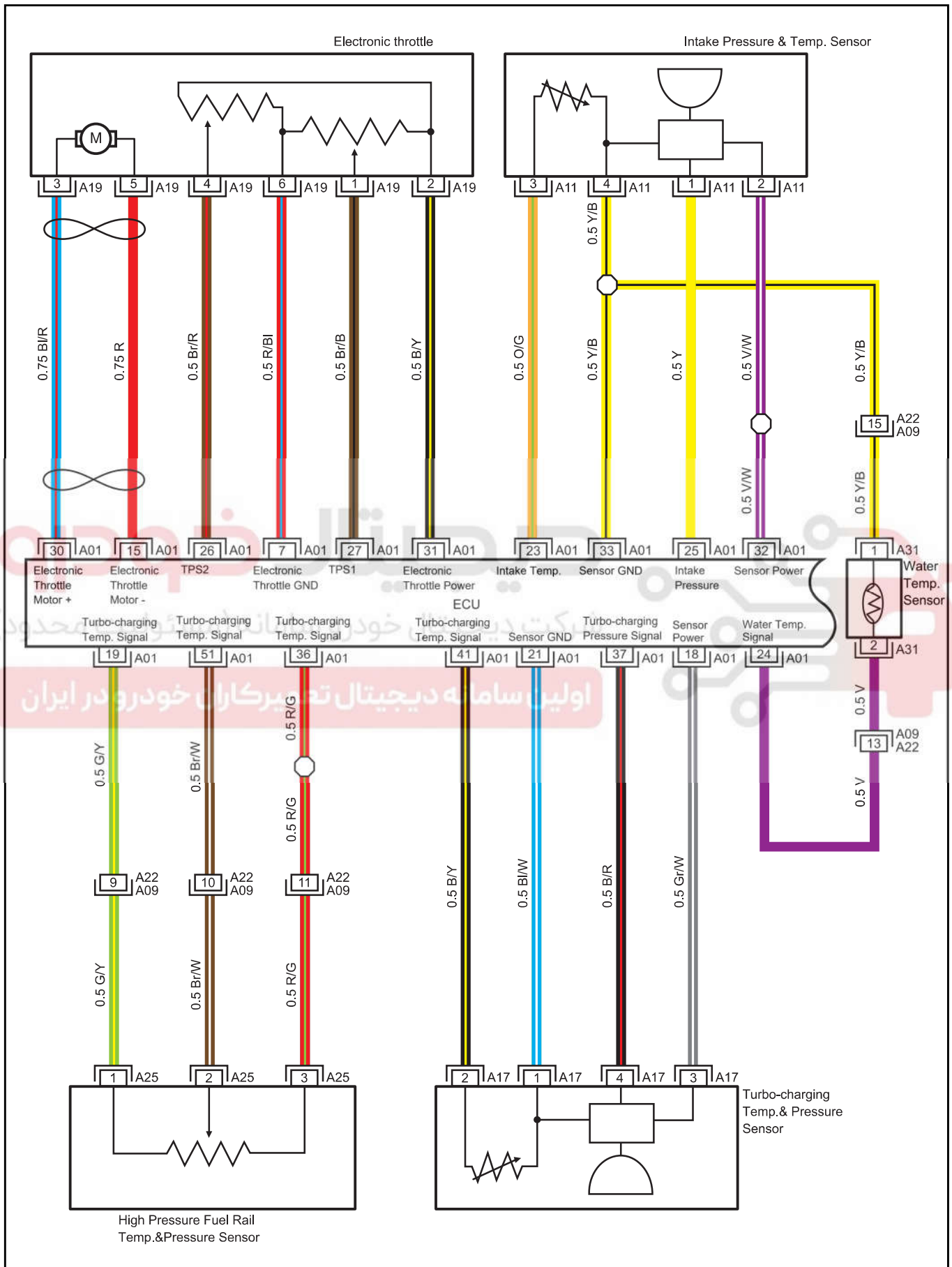

Connector	Name	Page
A01	ECU-E	19
A09	To Control W.H. Connector I	19
A11	Intake Temp.& Pressure Sensor	19
A17	Turbo-charging Pressure Sensor	19
A19	Throttle	19
A22	To Control W.H. Connector II	19
A25	Rail Pressure Sensor	19
A31	Water Temp. Sensor	19

دیجیتال خودرو

شرکت دیجیتال خودرو سامانه (مسئولیت محدود)

اولین سامانه دیجیتال تعمیرکاران خودرو در ایران

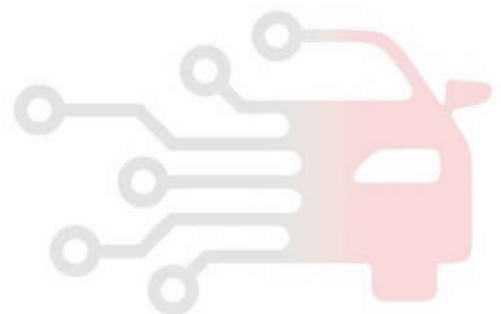

A11 Intake Temp.& Pressure Sensor

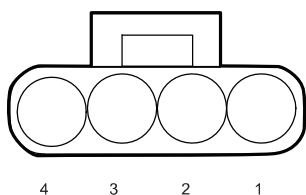

A01 ECU-E

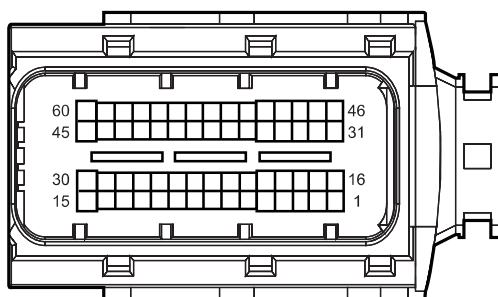

A17 Turbo-charging Pressure Sensor

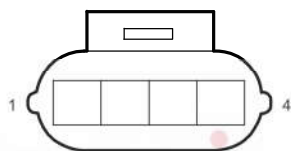

A09 To Control W.H. Connector I

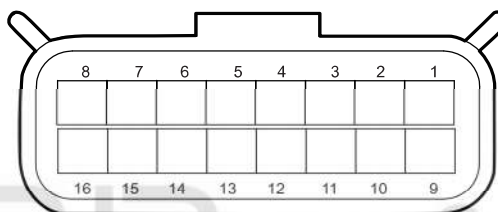

دیجیتال خودرو
شرکت دیجیتال خودرو سامانه (مسئولیت محدود)
اولین سامانه دیجیتال تعمیرکاران خودرو در ایران

A19 Throttle

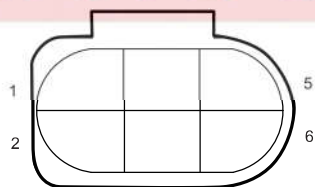

A22 To Control W.H. Connector ii

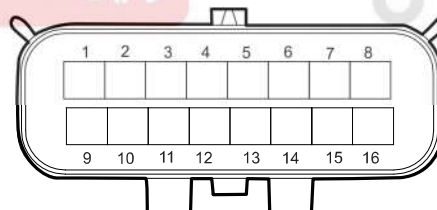

A25 Rail Pressure Sensor

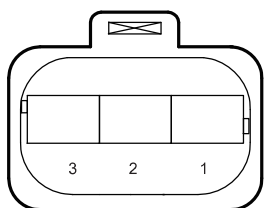

A31 Water Temp. Sensor

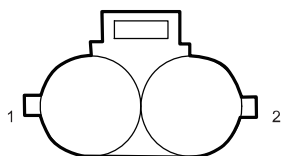

EMS Sensor 2

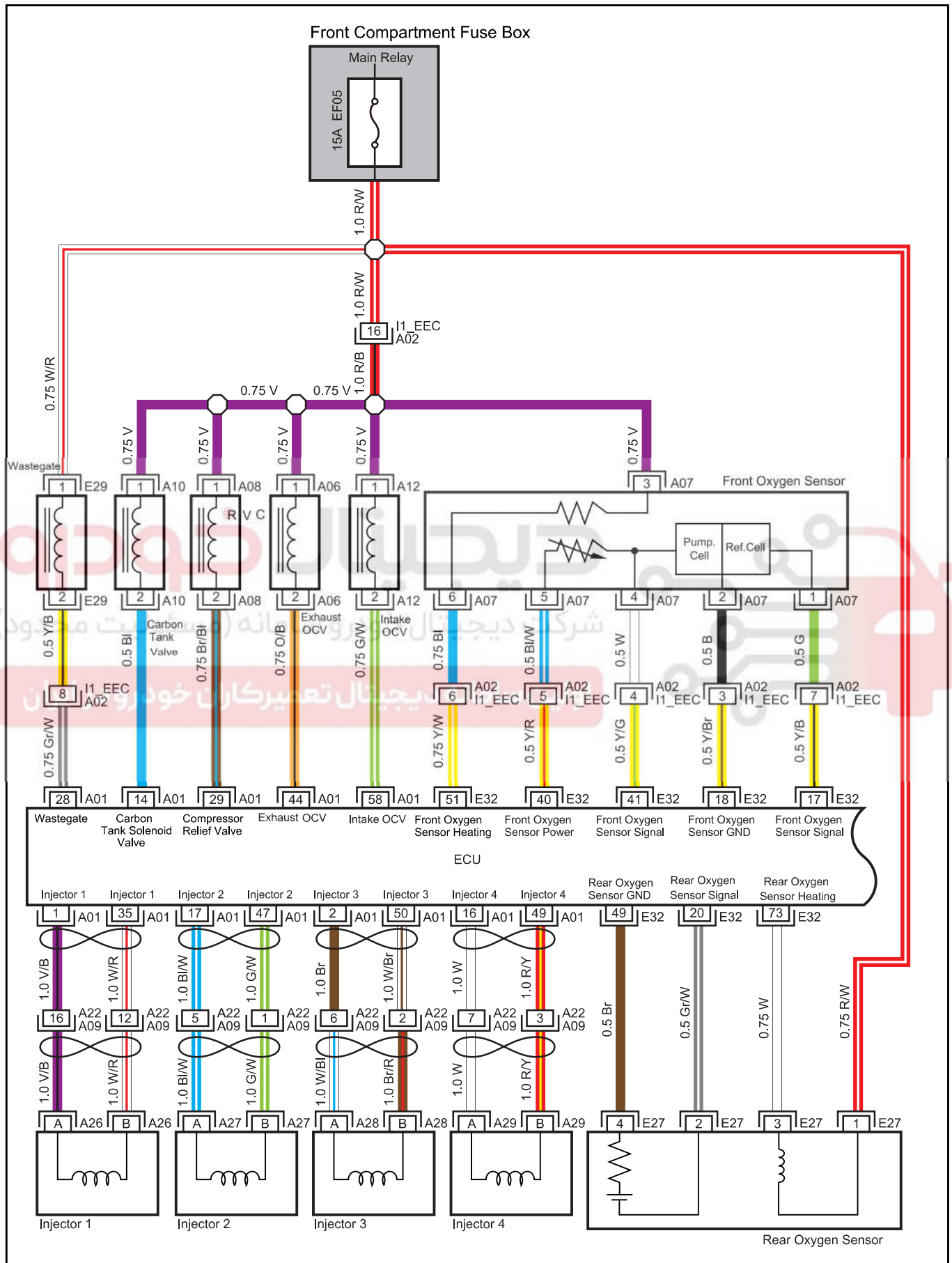

Connector	Name	Page
A01	ECU-E	19
A02	To Vehicle Connector	19
A06	Exhaust OVC	19
A07	Front Oxygen Sensor	19
A08	RVC	19
A09	To Control W.H. Connector I	19
A10	Carbon Tank Solenoid Valve	19
A12	Intake OCV	19
A22	To Control W.H. Connector ii	19
A26	Injector 1	19
A27	Injector 2	19
A28	Injector 3	19
A29	Injector 4	19
E27	Rear Oxygen Sensor _1.5T	16
E29	Turbo-charging Control	17
E32	1.5T Engine W.H. Connector Connecting EMS	17
I1_EEC	Engine W.H. Connector Connecting Engine Control W.H.(National VI)	17

دیجیتال خودرو

شرکت دیجیتال خودرو سامانه (مسئولیت محدود)

اولین سامانه دیجیتال تعمیرکاران خودرو در ایران

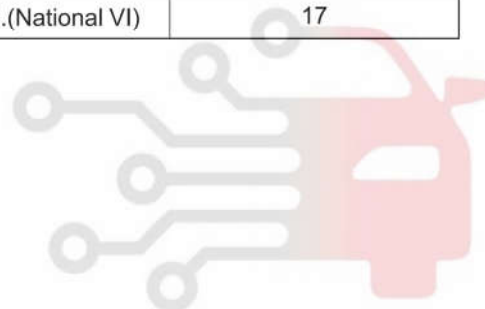

A01 ECU-E

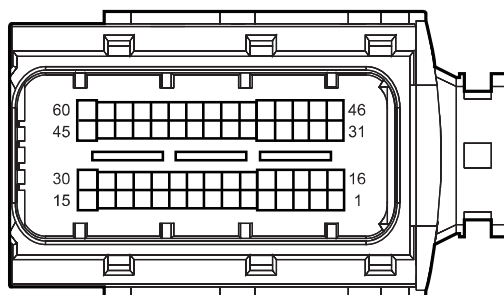

A06 Exhaust OCV

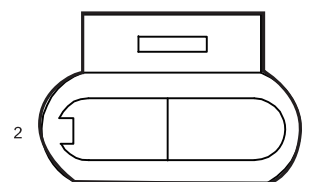

A02 To Vehicle Connector



A07 Front Oxygen Sensor

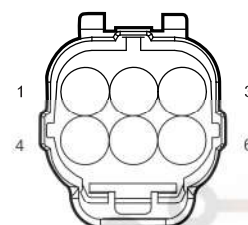

A09 To Control W.H. Connector I

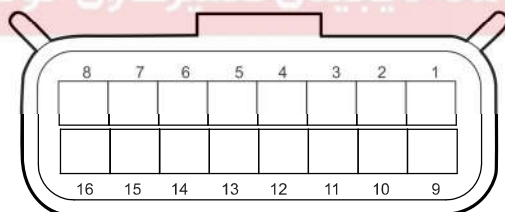

A08 RCV

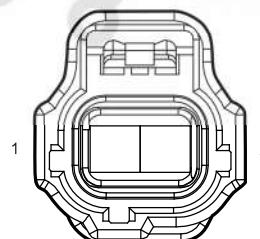

A10 Carbon Tank Solenoid Valve

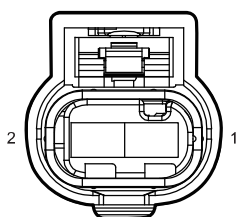

A12 Intake OCV

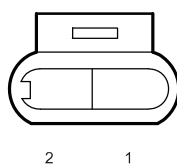

A22 To Control W.H. Connector II

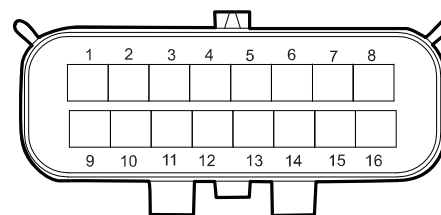

دیجیتال خودرو
 شرکت دیجیتال خودرو سامانه (مسئولیت محدود)
 اولین سامانه دیجیتال تعمیرکاران خودرو در ایران

A26 Injector 1

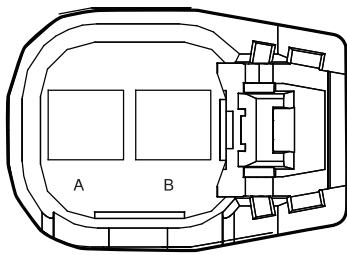

A27 Injector 2

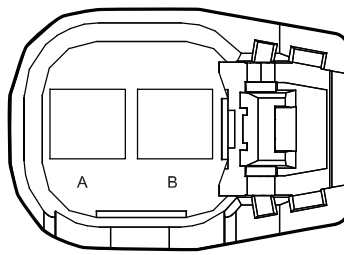

A28 Injector 3

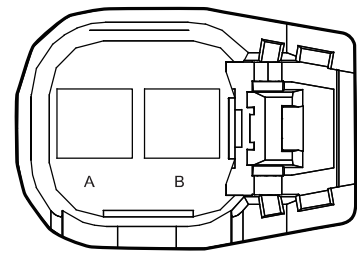

A29 Injector 4

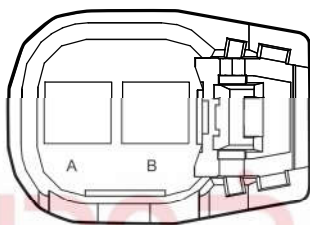

E27 Rear Oxygen Sensor

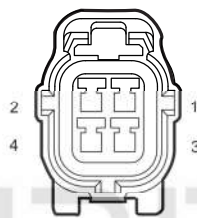

E29 Turbo-charging Control

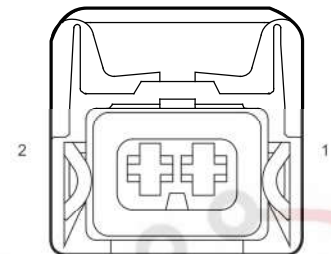

E32 1.5T Engine W.H. Connector Connecting EMS

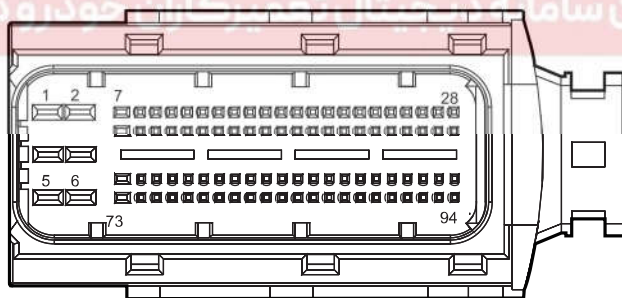

I1_EEC Engine W.H. Connector Connecting Engine Control W.H.(National VI)

6	5	4	3	2	1
	7	8	9	10	
16	15	14	13	12	11
26	25	24	23	22	21

دیجیتال خودرو
 شرکت دیجیتال خودرو سامانه (مسئولیت محدود)
 اولین سامانه دیجیتال تعمیرگاه خودرو در ایران

EMS Sensor 3

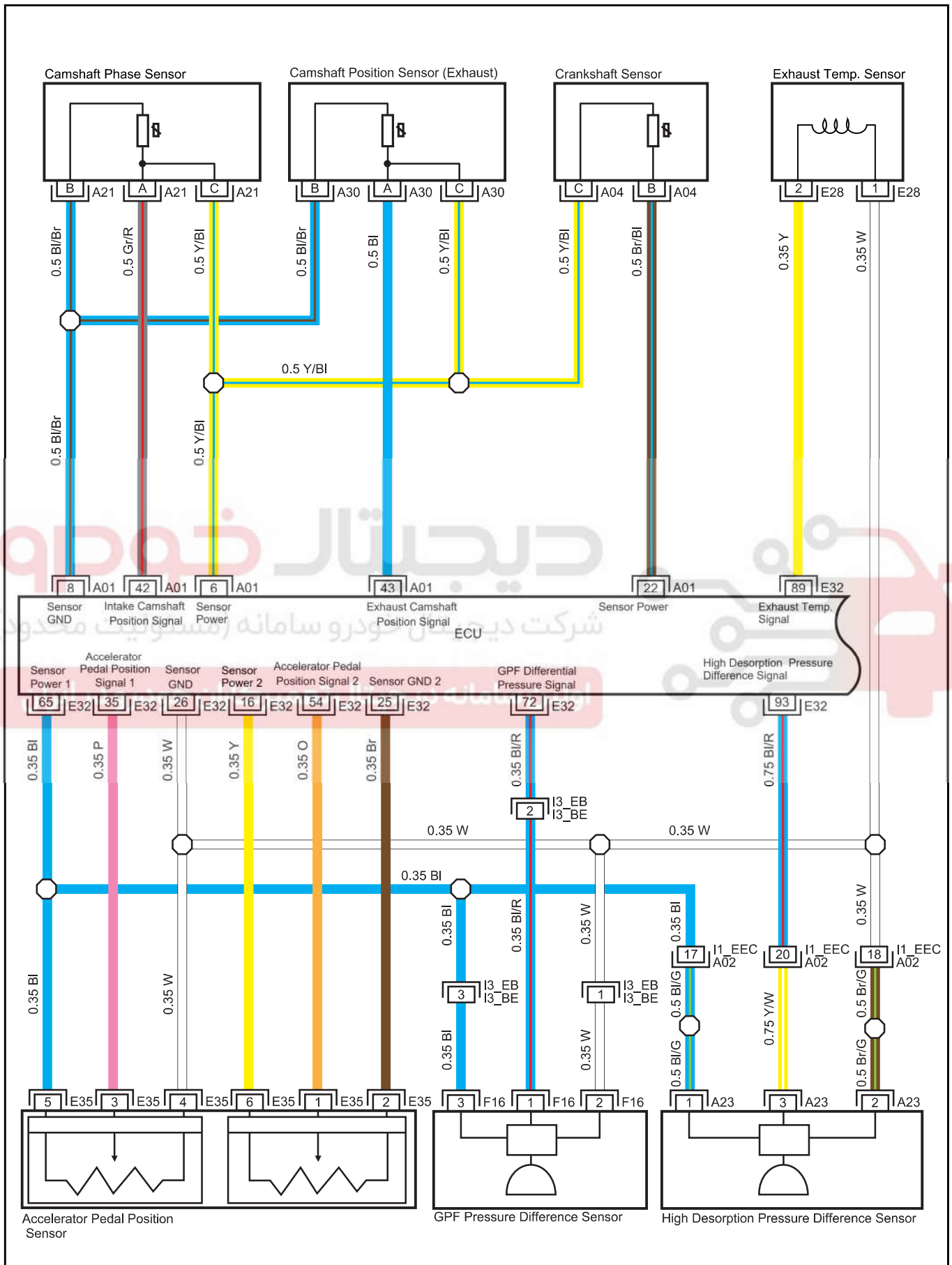

Connector	Name	Page
A01	ECU-E	19
A02	To Vehicle Connector	19
A04	Crankshaft Sensor	19
A21	Camshaft Phase Sensor	19
A30	Camshaft Position Sensor (Exhaust)	19
A23	High Desorption Pressure Difference Sensor	19
E28	Exhaust Temp. Sensor	16
E32	1.5T Engine W.H. Connector Connecting EMS	17
E35	Accelerator Pedal Position Sensor	16
F16	GPF Pressure Difference Sensor	26
I1_EEC	Engine W.H. Connector Connecting Engine Control W.H.(National VI)	17
I3_BE	Body W.H. Connector 3 Connecting Engine W.H.	26
I3_EB	Engine W.H. Connector 3 Connecting Body W.H.	17

دیجیتال خودرو

شرکت دیجیتال خودرو سامانه (مسئولیت محدود)

اولین سامانه دیجیتال تعمیرکاران خودرو در ایران

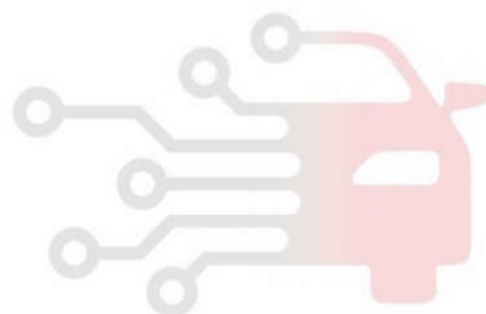

A01 ECU-E

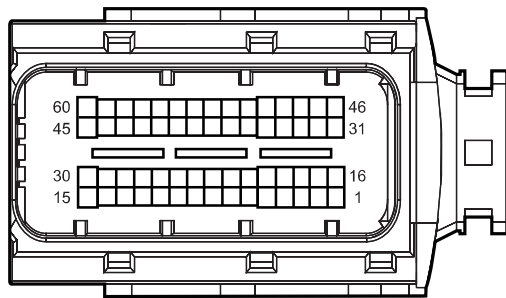

A04 Crankshaft Sensor

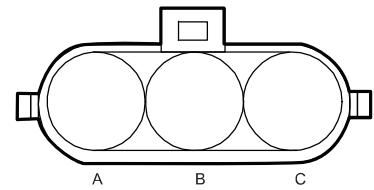

A02 To Vehicle Connector



A21 Camshaft Phase Sensor

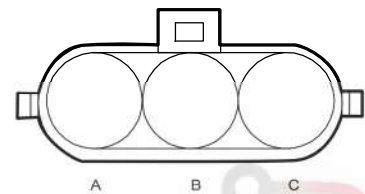

دیجیتال خودرو
شرکت دیجیتال خودرو سامانه (مسئولیت محدود)
اولین سامانه دیجیتال تعمیرکاران خودرو در ایران

A23 High Desorption Pressure Difference Sensor

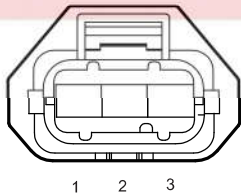

A30 Camshaft Position Sensor (Exhaust)

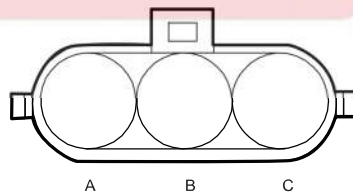

E28 Exhaust Temp. Sensor

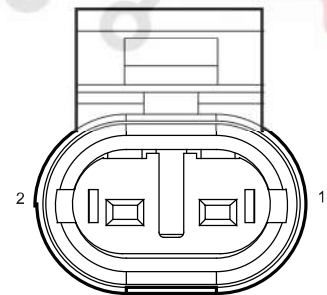

E32 1.5T Engine W.H. Connector Connecting EMS

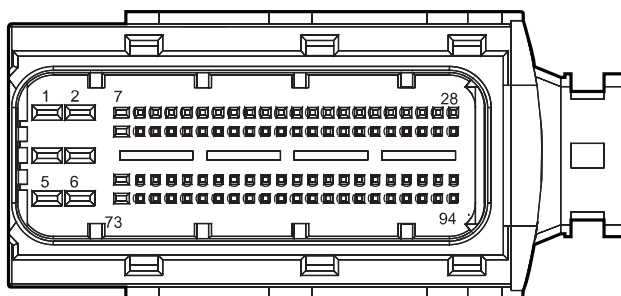

E35 Accelerator Pedal Position Sensor

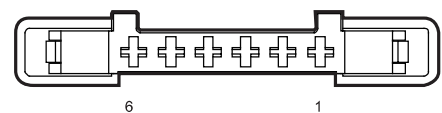

F16 GPF Pressure Difference Sensor

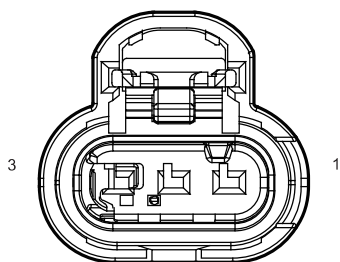

I1_EEC Engine W.H. Connector Connecting Engine Control W.H.(National VI)

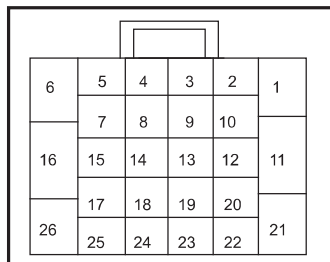

I3_BE Body W.H. Connector 3 Connecting Engine W.H.

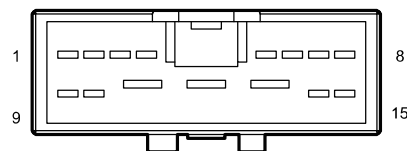

I3_EB Engine W.H. Connector 3 Connecting Body W.H.

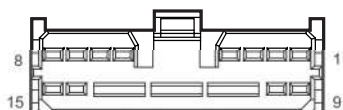

دیجیتال خودرو
شرکت دیجیتال خودرو سامانه (مسئولیت محدود)

اولین سامانه دیجیتال تعمیرکاران خودرو در ایران



EMS Sensor 4

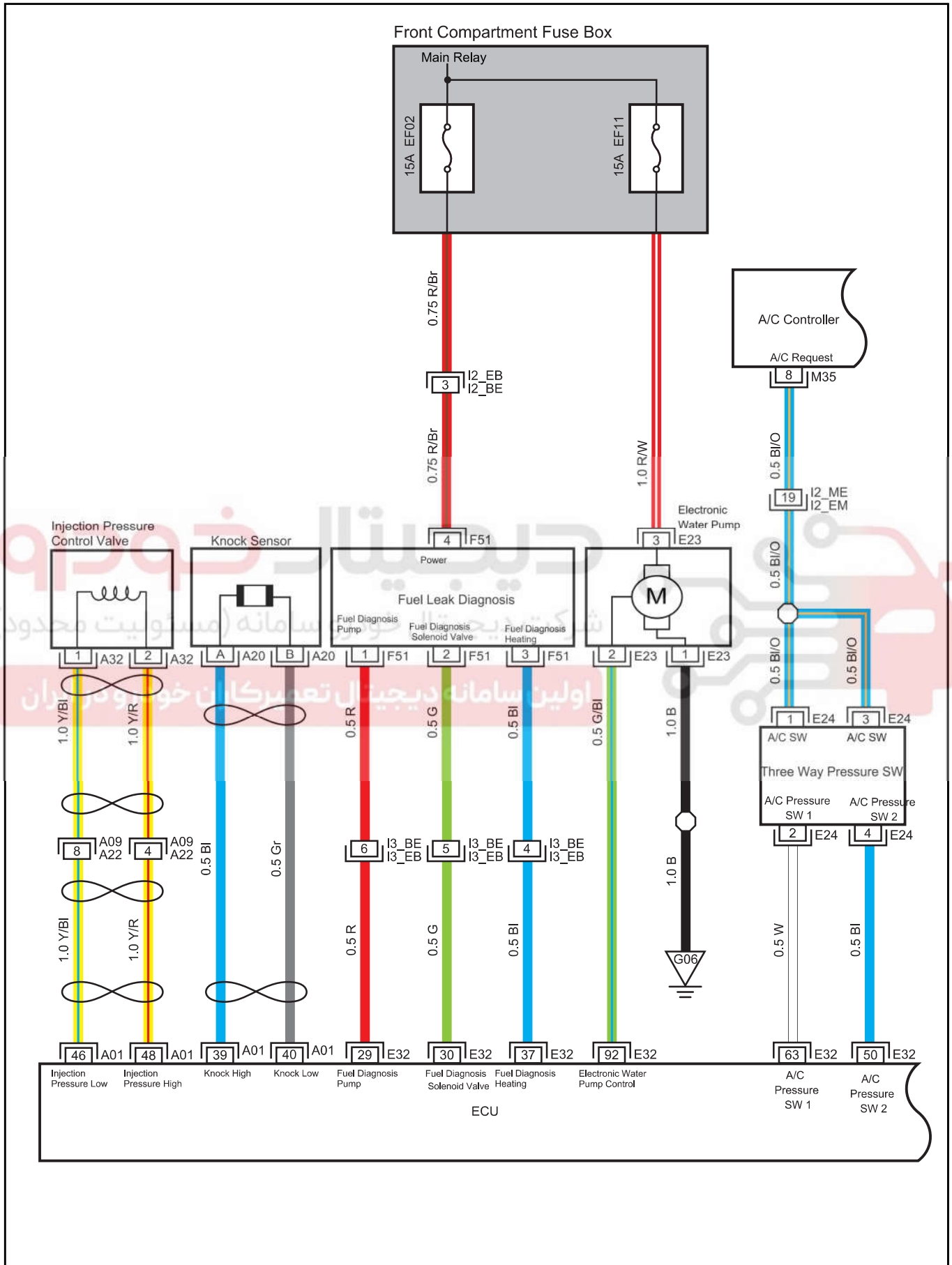

Connector	Name	Page
A01	ECU-E	19
A09	To Control W.H. Connector I	19
A20	Knock Sensor	19
A22	To Control W.H. Connector II	19
A32	High Pressure Fuel Pump	19
E23	Electronic Water Pump_1.5T	17
E24	Three Way Pressure SW	17
E32	1.5T Engine W.H. Connector Connecting EMS	17
F51	Fuel Leak Diagnosis Module	25
M35	A/C Controller B	21
G06	Electronic Water Pump GND	40
I2_BE	Body W.H. Connector 2 Connecting Engine W.H.	27
I2_EB	Engine W.H. Connector 2 Connecting Body W.H.	17
I2_EM	Engine W.H. Connector 2 Connecting Main W.H.	16
I2_ME	Main W.H. Connector 2 Connecting Engine W.H.	21
I3_BE	Body W.H. Connector 3 Connecting Engine W.H.	26
I3_EB	Engine W.H. Connector 3 Connecting Body W.H.	17

دیجیتال خودرو
شرکت دیجیتال خودرو سامانه (مسئولیت محدود)

اولین سامانه دیجیتال تعمیرکاران خودرو در ایران

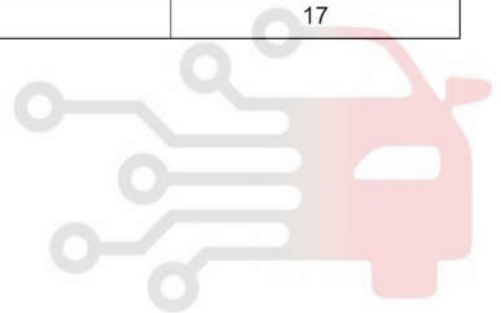

A01 ECU-E

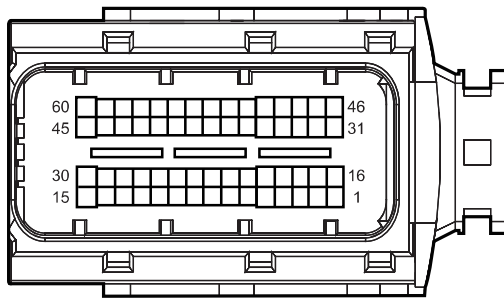

A20 Knock Sensor

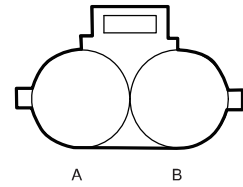

A09 To Control W.H. Connector I

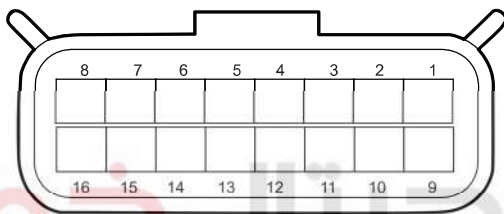

A22 To Control W.H. Connector II

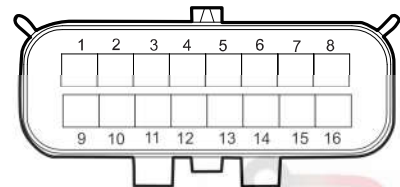

E23 Electronic Water Pump

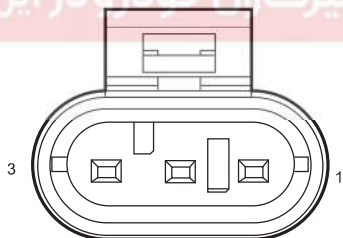

E24 Three Way Pressure SW

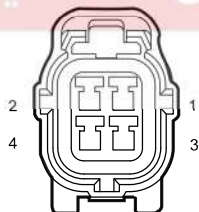

A32 High Pressure Fuel Pump

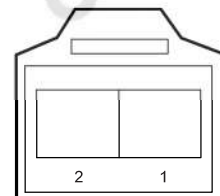

E32 1.5T Engine W.H. Connector Connecting EMS

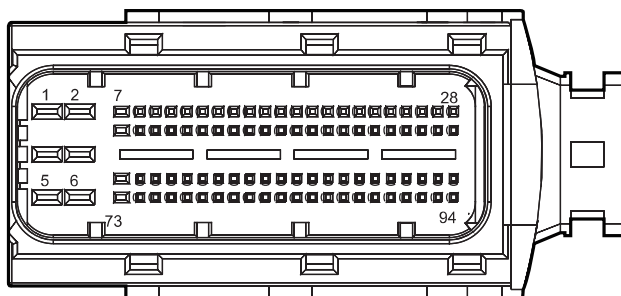

F51 Fuel Leak Diagnosis Module

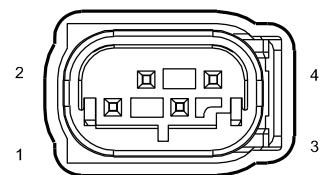

G06 Electronic Water Pump GND



I2_EM Engine W.H. Connector 2
Connecting Main W.H.

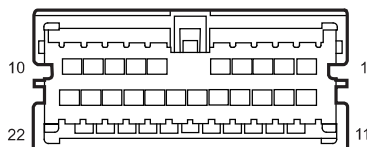

I2_ME Main W.H. Connector 2
Connecting Engine W.H.

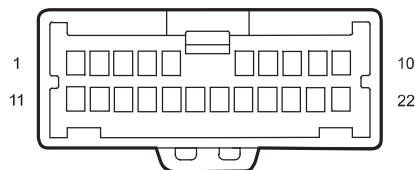

I2_BE Body W.H. Connector 2
Connecting Engine W.H.

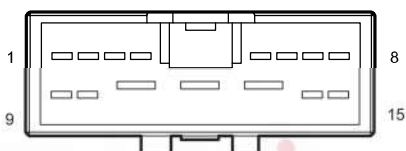

I2_EB Engine W.H. Connector 2
Connecting Body W.H.

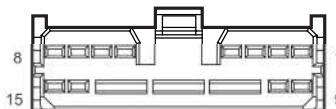

I3_EB Engine W.H. Connector 3
Connecting Body W.H.

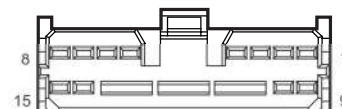

I3_BE Body W.H. Connector 3
Connecting Engine W.H.

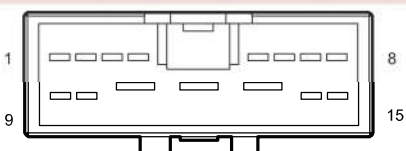

M35 A/C Controller B

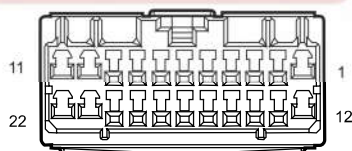

دیجیتال خودرو
شرکت دیجیتال خودرو سامانه (مسئولیت محدود)

اولین سامانه دیجیتال تعمیرکاران خودرو در ایران

