

Cluster

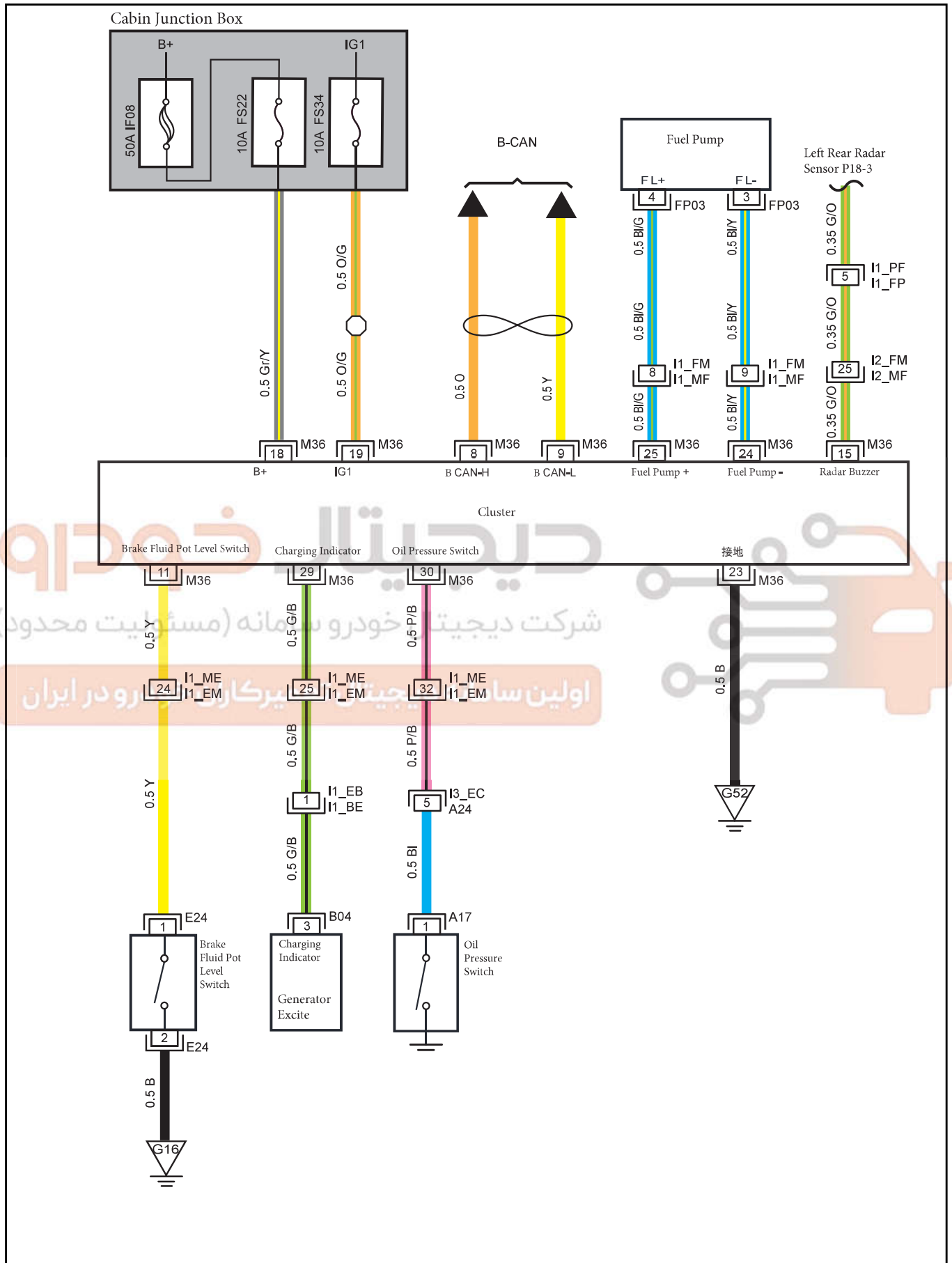

Harness Connector	Name	Page
A17	Oil Pressure Switch	18
A24	To Vehicle Harness	18
B04	Generator excitation	14
E24	Brake Fluid Pot Level Switch	16
FP03	Fuel Pump	27
M07	Clock Spring-Horn	21
M36	Cluster	21
W09	Trunk Lock	34
I1_ME	Main Harness to Engine Harness 1	20
I1_EM	Engine Harness to Main Harness 1	16
I1_EB	Engine Harness to Power Harness	16
I1_BE	Power Harness to Engine Harness	14
I3_EC	Engine Harness to Control Harness	16
I1_MF	Main Harness to Body Harness 1	20
I1_FM	Body Harness to Main Harness 1	25
I1_FP-F	Fuel Tank Harness to Body Harness	27
I1_F-FP	Body Harness to Fuel Tank Harness	26
I1_PF	Reverse Radar Harness to Body Harness	36
I1_FP	Body Harness to Reverse Radar Harness	25
I2_FM	Body Harness to Main Harness II	26
I2_MF	Main Harness to Body Harness II	21
G16	Front Wiper GND	42
G52	Cluster GND	43

A17 Oil Pressure Switch

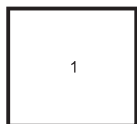

A24 To Vehicle Harness

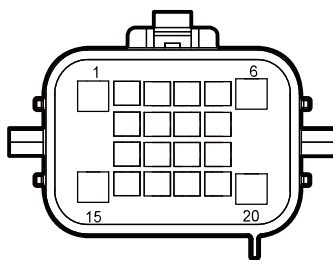

B04 Generator excitation

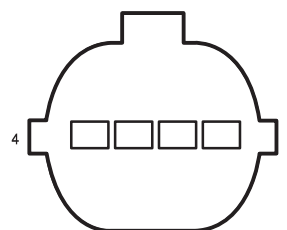

I1_ME Main Harness to Engine Harness 1

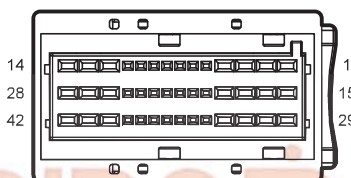

E24 Brake Fluid Pot Level Switch

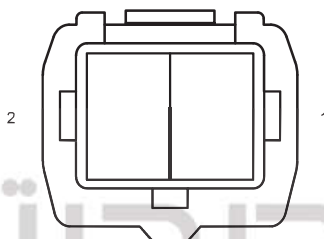

FP03 Fuel Pump

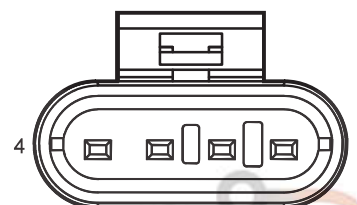

شرکت دیجیتال خودرو (مسئولیت محدود)

G52 Cluster GND

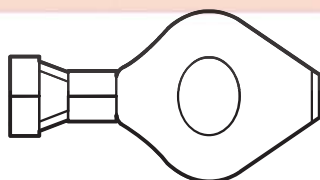

G16 Front Wiper GND

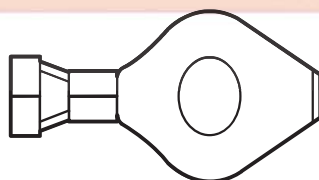

M07 Clock Spring-Horn

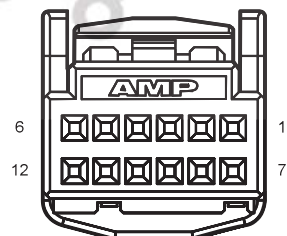

M36 Cluster

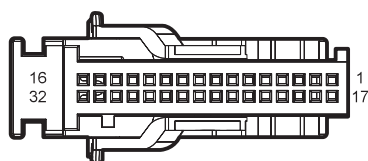

W09 Trunk Lock

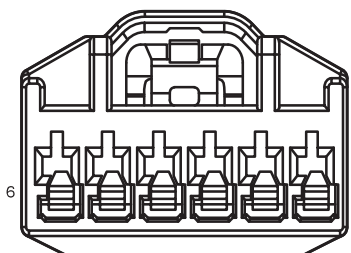

I1_EM Engine Harness to Main Harness 1

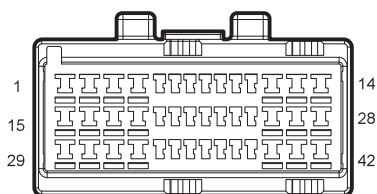

I1_EB Engine Harness to Power Harness

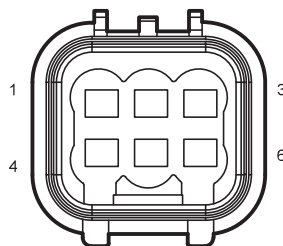

I1_BE Power Harness to Engine Harness

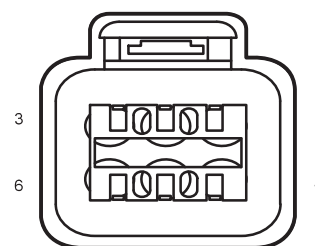

I3_EC Engine Harness to Control Harness

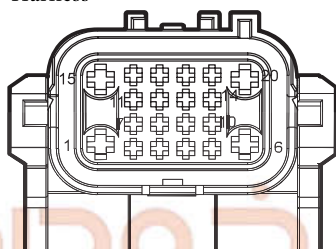

I1_MF Main Harness to Body Harness 1

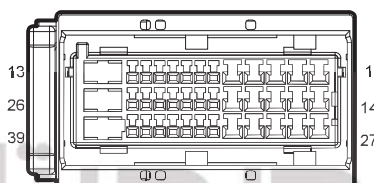

I2_MF Main Harness to Body Harness II

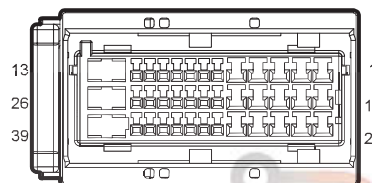

I1_FM Body Harness to Main Harness 1

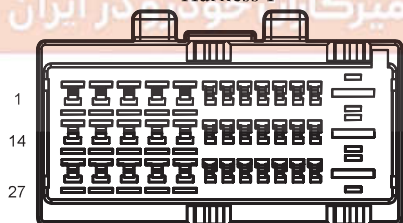

I2_FM Body Harness to Fuel Tank Harness

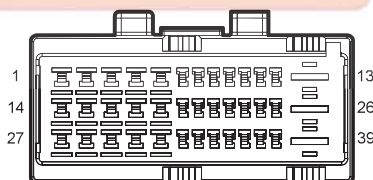

I1_PF Reverse Radar Harness to Body Harness

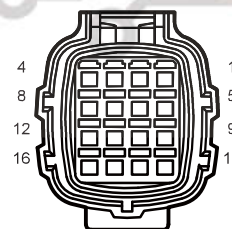

I1_FP Body Harness to Reverse Radar Harness

