

Charging (2AR-FE) (Except Korea) (From Oct. 2015 Production)

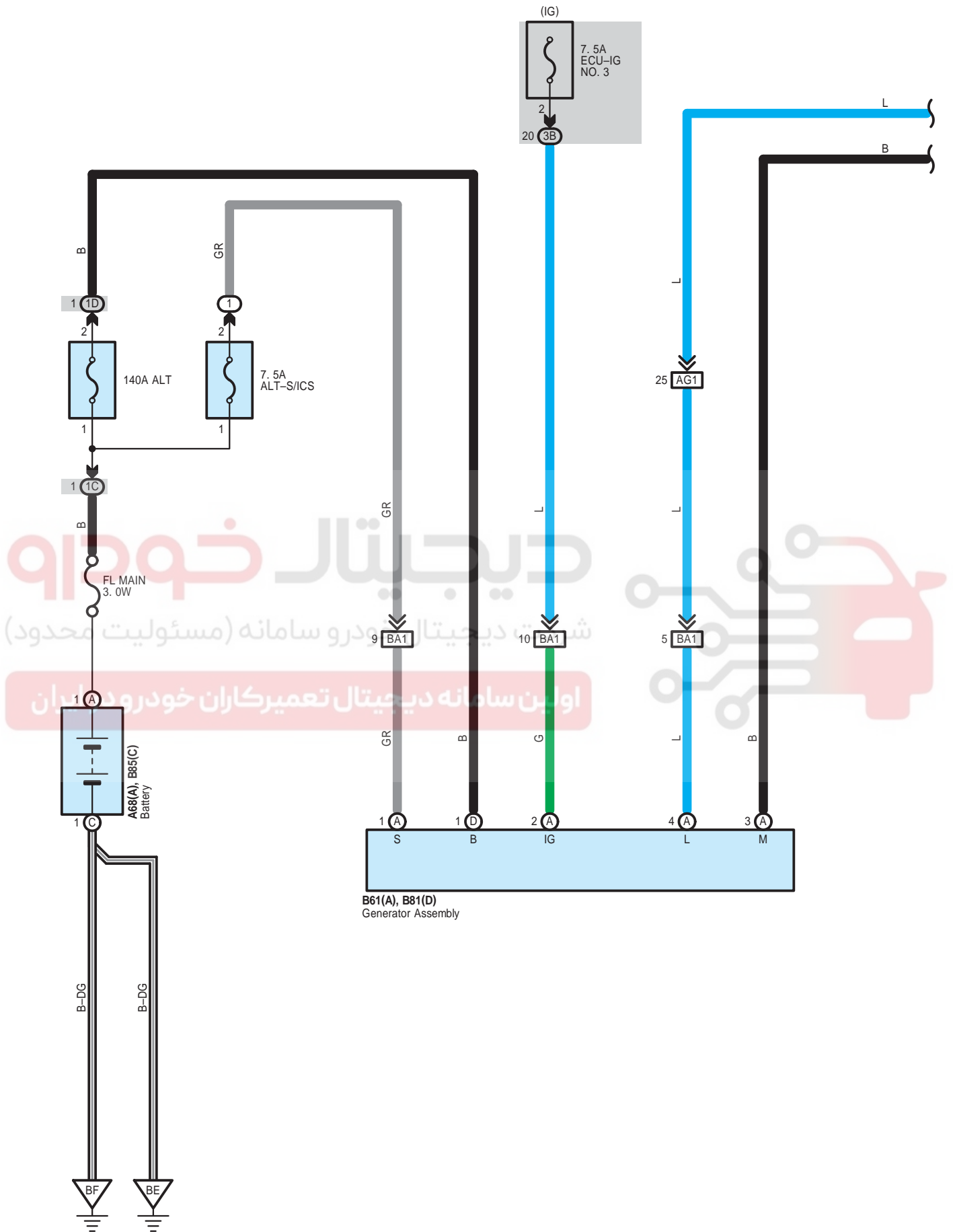

Charging (2AR-FE) (Korea) (From Oct. 2015 Production)

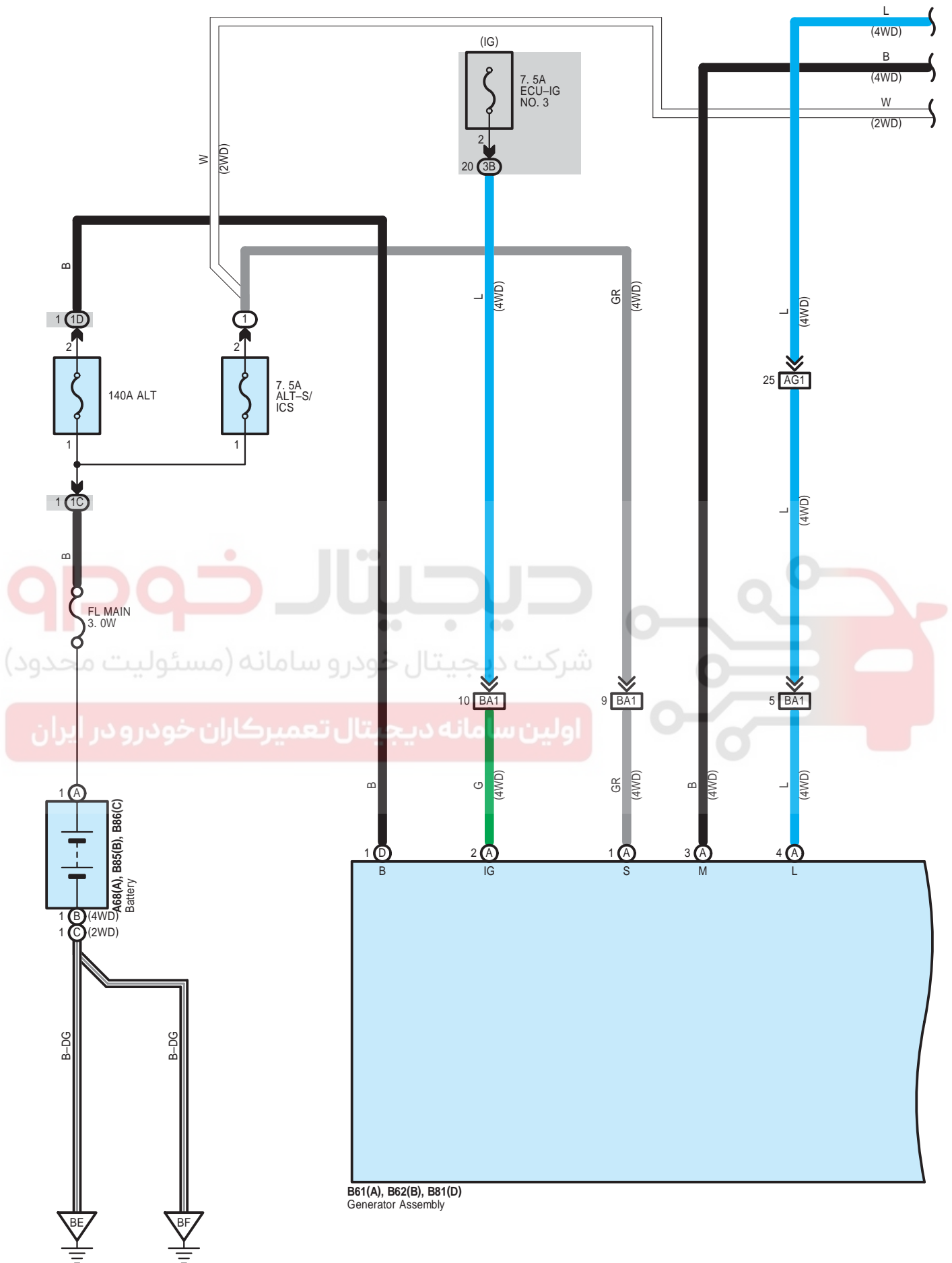

Charging (2AR-FE) (Korea) (From Oct. 2015 Production)

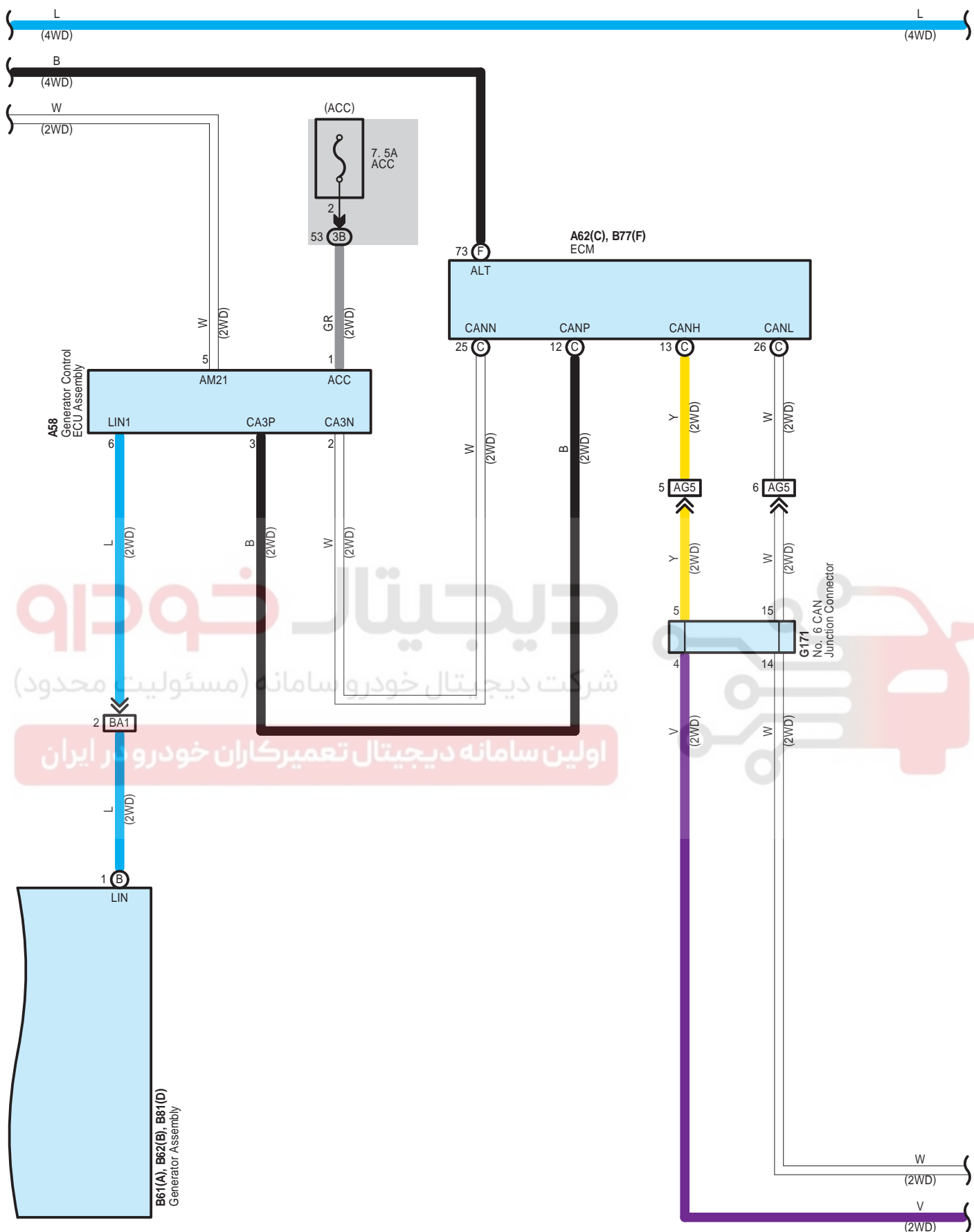

Charging (2AR-FE) (Korea) (From Oct. 2015 Production)

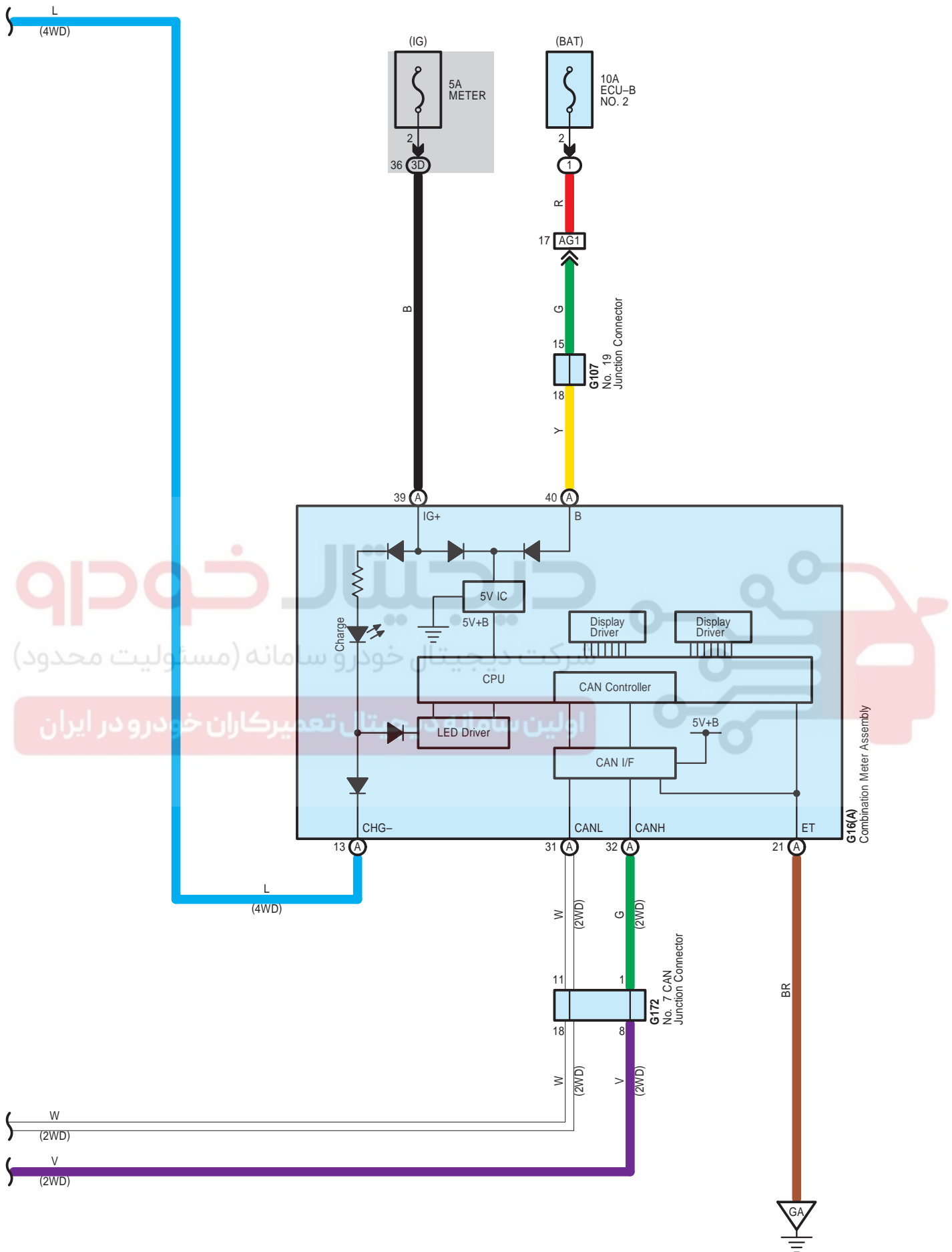

Charging (2AR-FE) (Korea) (From Oct. 2015 Production)

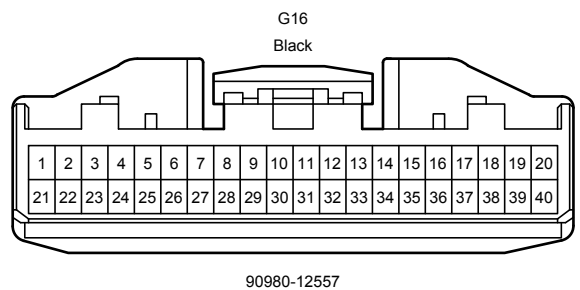
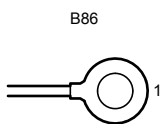
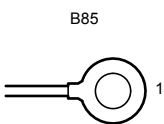
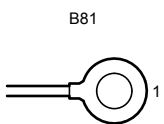
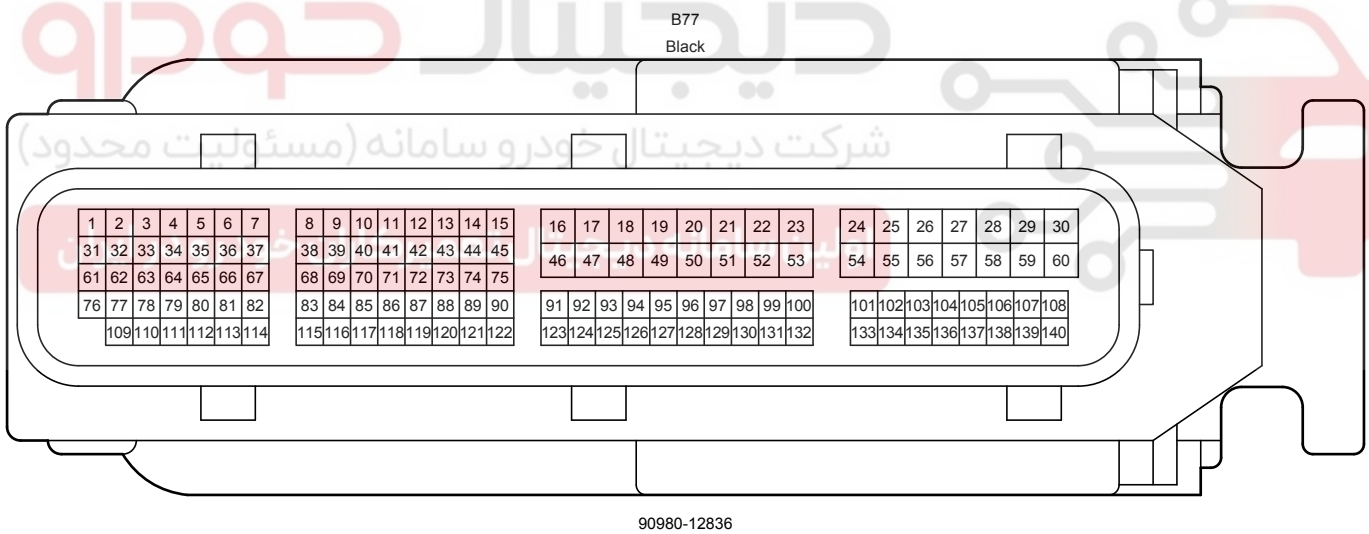
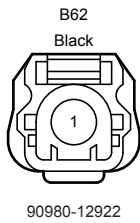
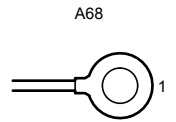
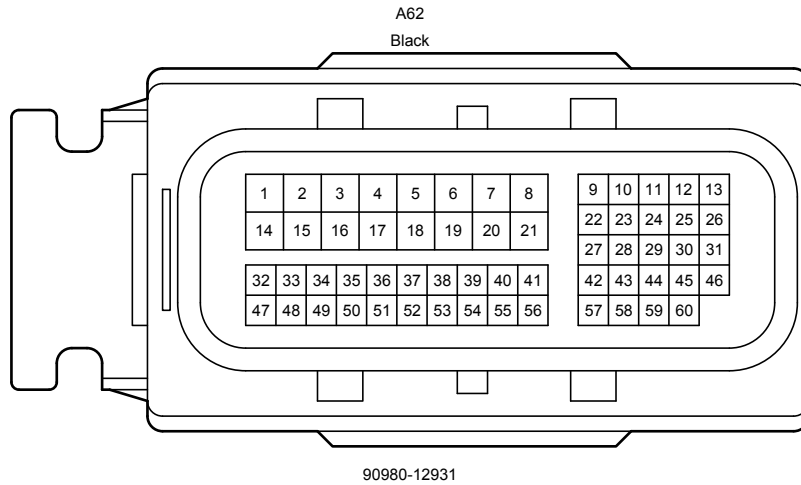
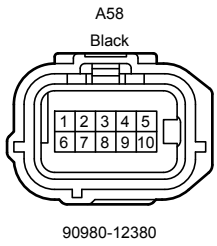

Charging (2AR-FE) (Korea) (From Oct. 2015 Production)

G107  
Gray

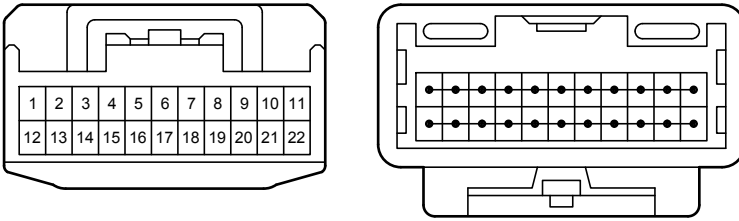

90980-12372

G171  
White

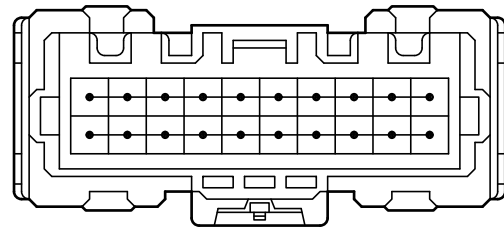
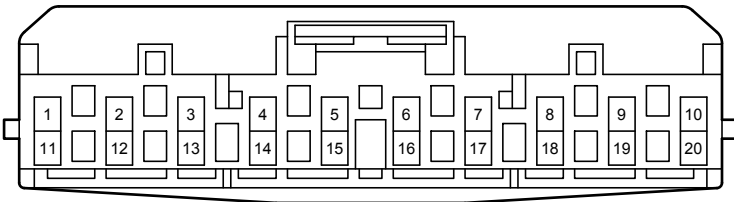

90980-12A58

G172  
White

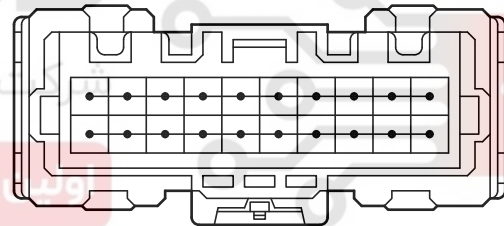
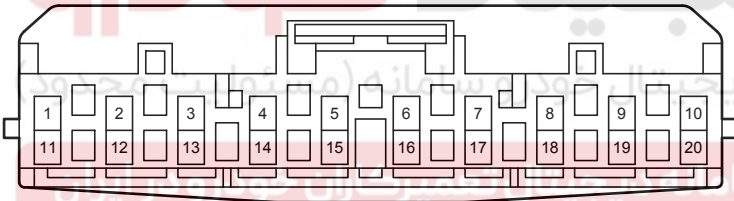

90980-12A58

1C  
White

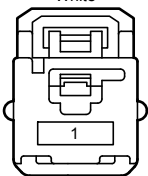

90980-12756

1D



90980-09877

3B  
White

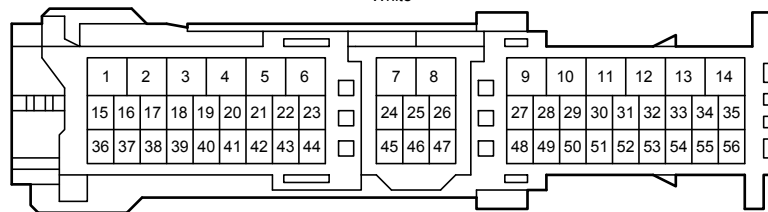

90980-12A15

Charging (2AR-FE) (Korea) (From Oct. 2015 Production)

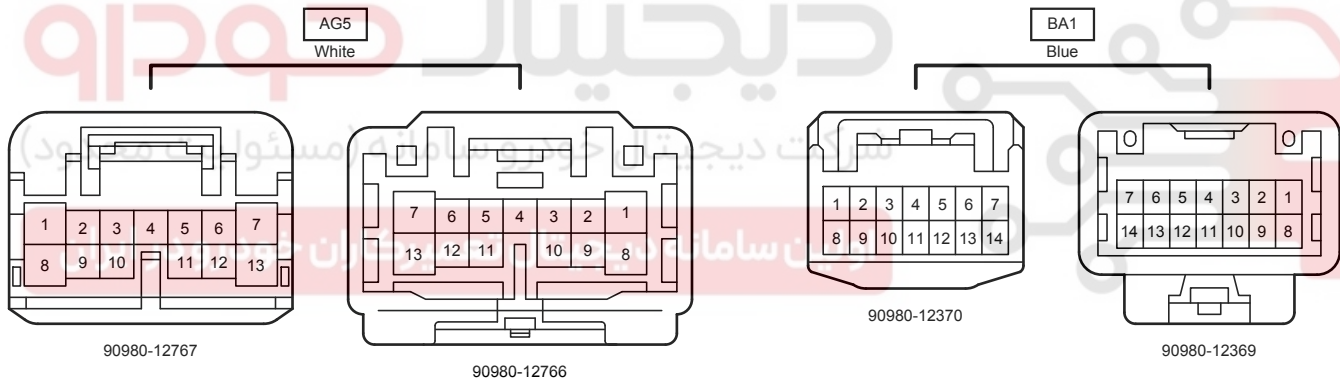
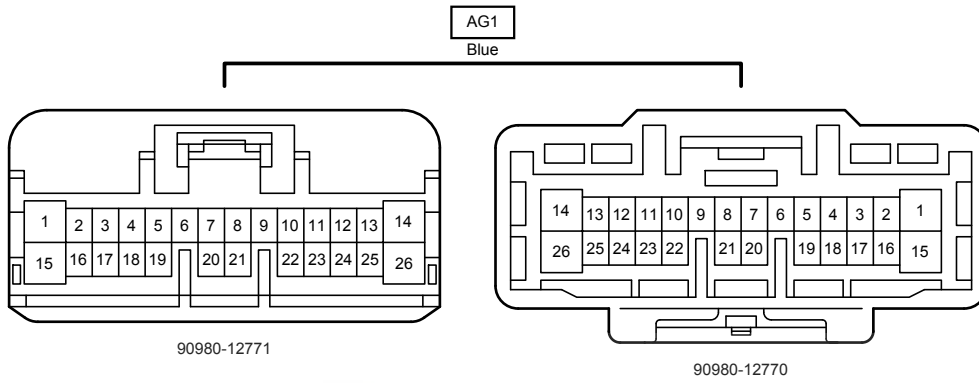
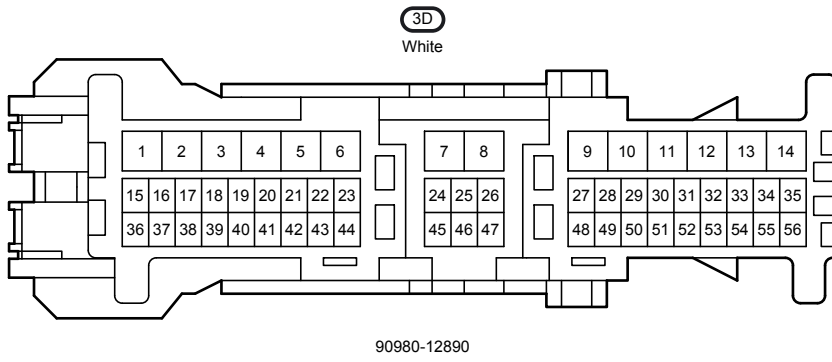

Charging (2AR-FE) (Except Korea) (From Oct. 2015 Production)

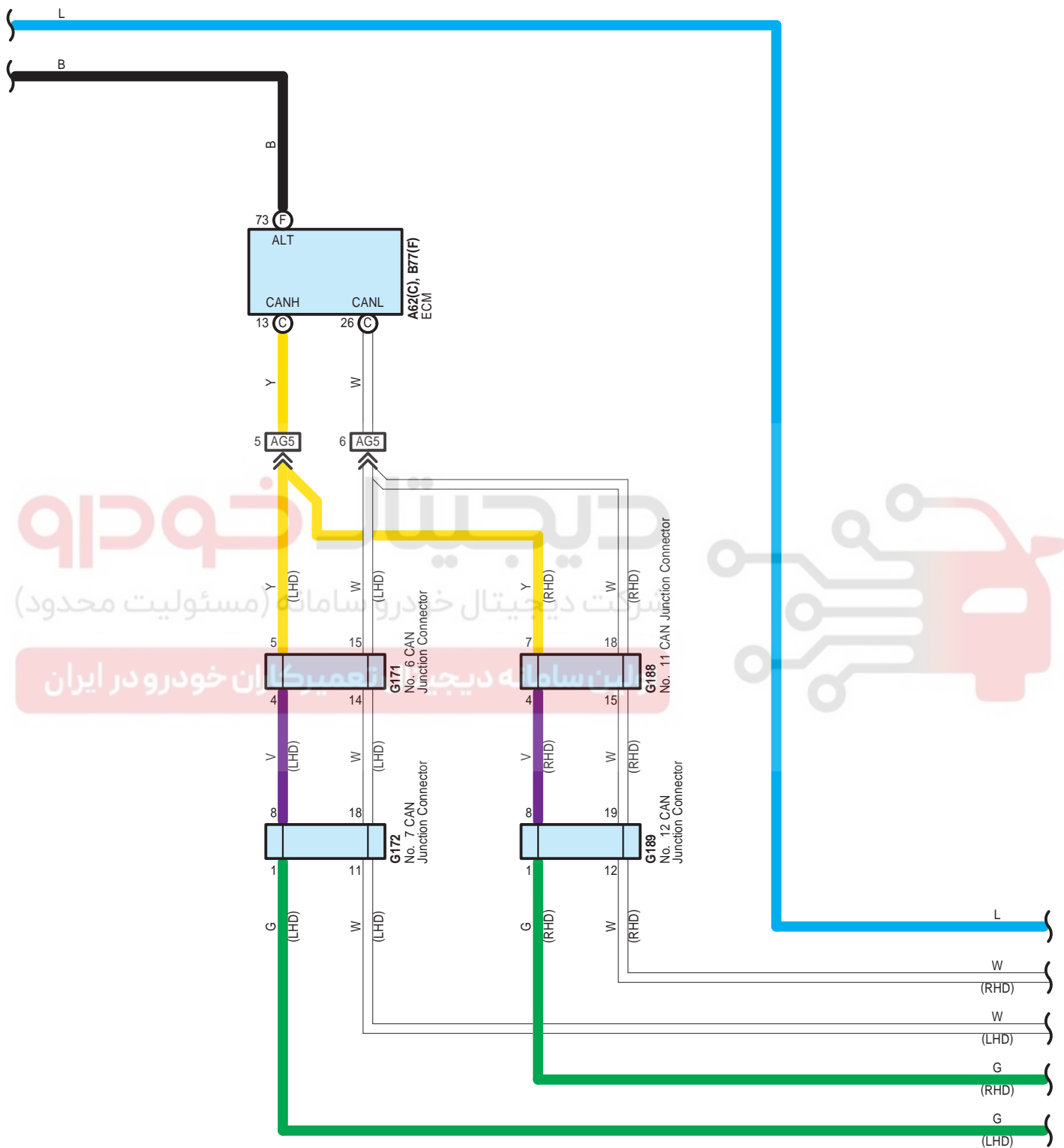



Charging (2AR-FE) (Except Korea) (From Oct. 2015 Production)

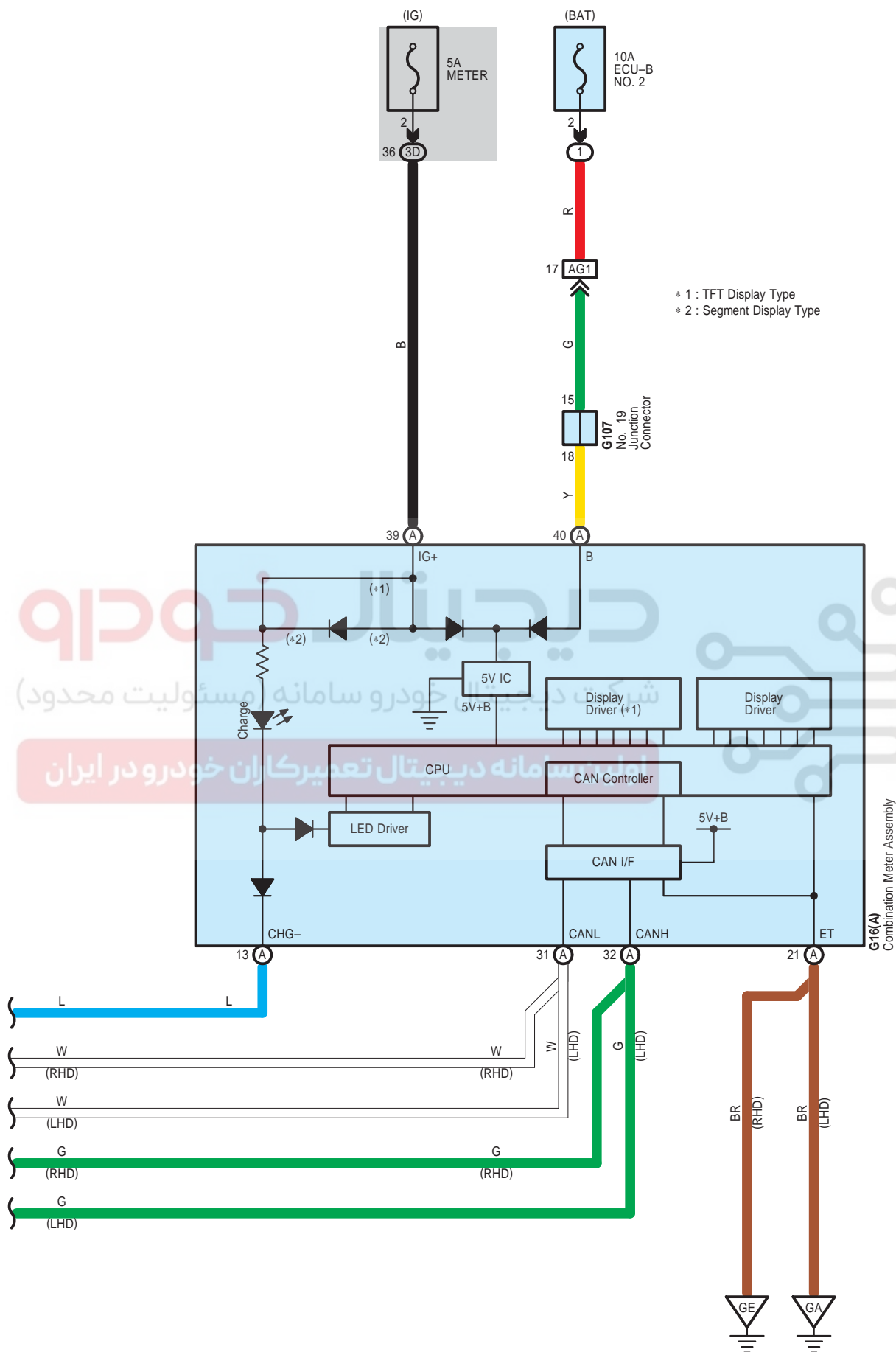

Charging (2AR-FE) (Except Korea) (From Oct. 2015 Production)

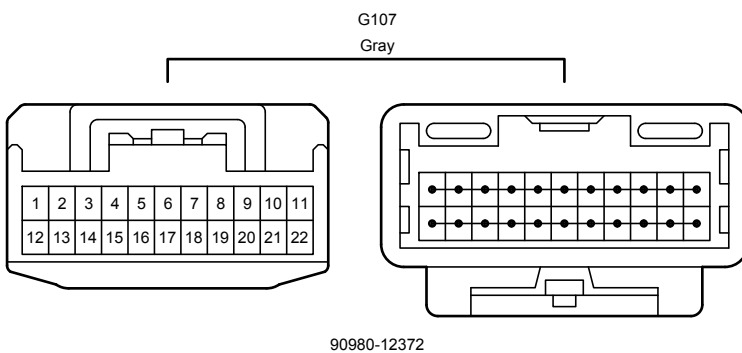
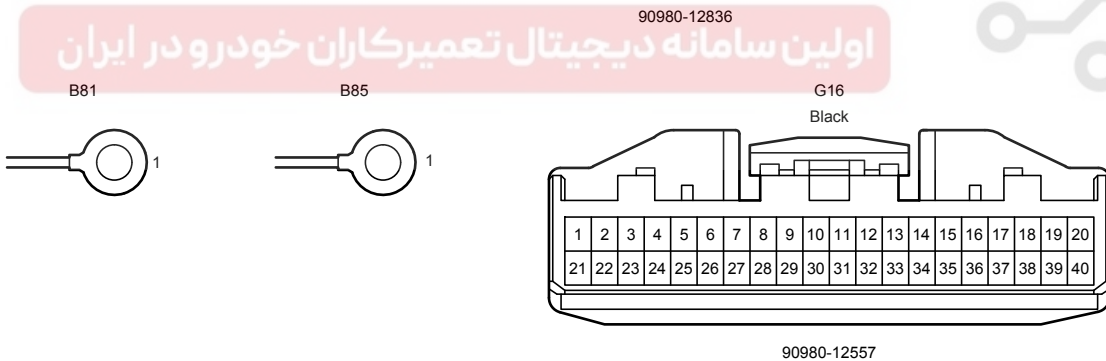
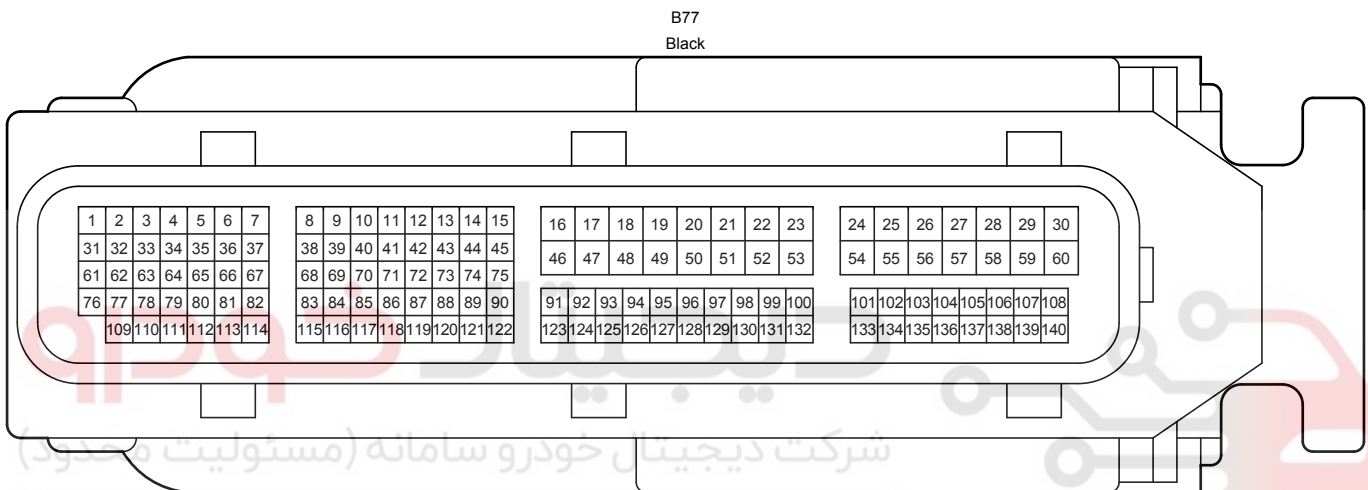
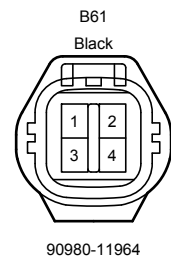
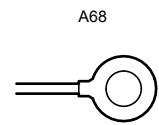
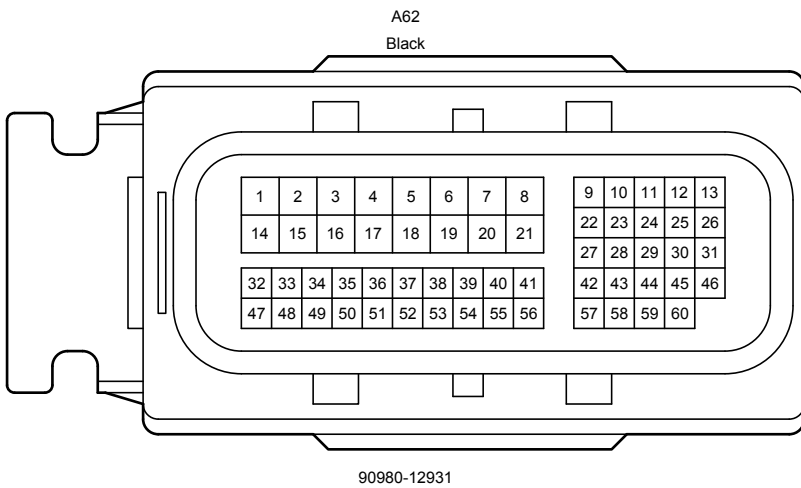

Charging (2AR-FE) (Except Korea) (From Oct. 2015 Production)

G171  
White

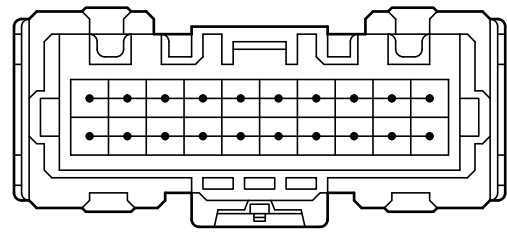
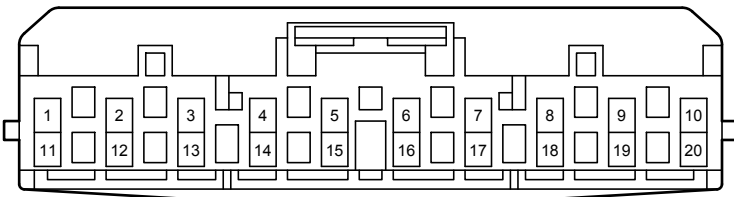

90980-12A58

G172  
White

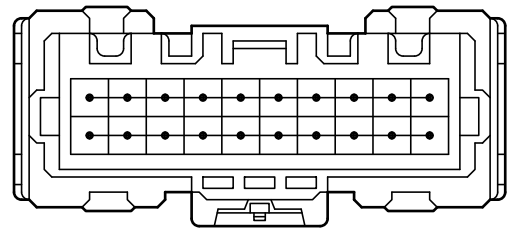
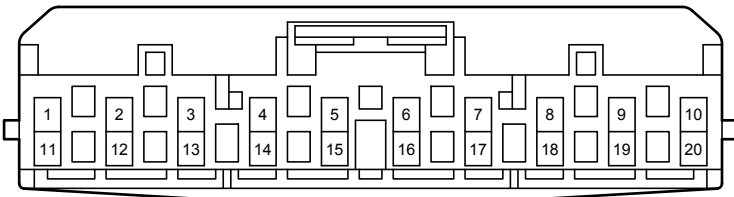

90980-12A58

G188  
Gray

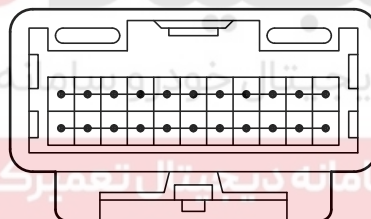
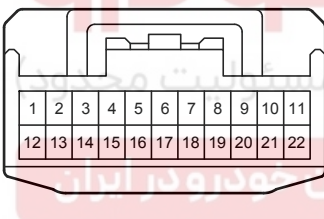

90980-12372

G189  
Gray

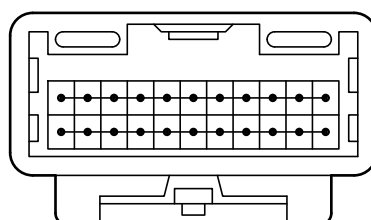
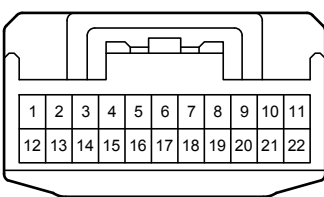

90980-12372

1C  
White

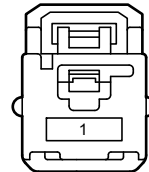

90980-12756

1D

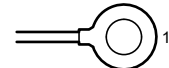

90980-09877

Charging (2AR-FE) (Except Korea) (From Oct. 2015 Production)

3B

White

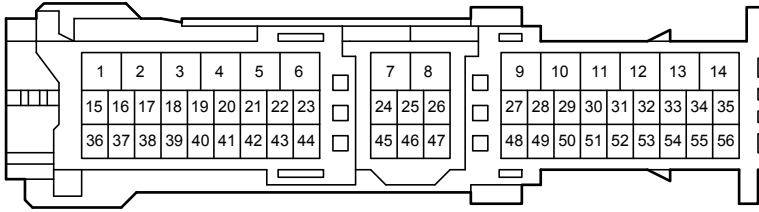

90980-12A15

3D

White

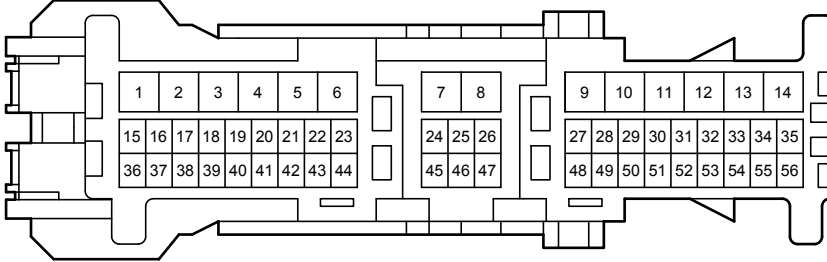

90980-12890

AG1

Blue

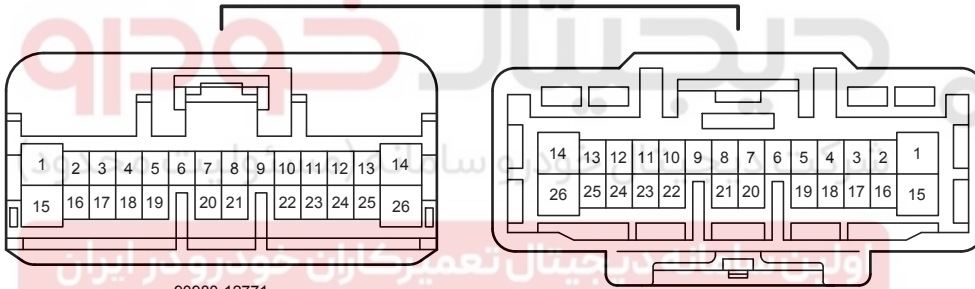

90980-12771

90980-12770

AG5

White

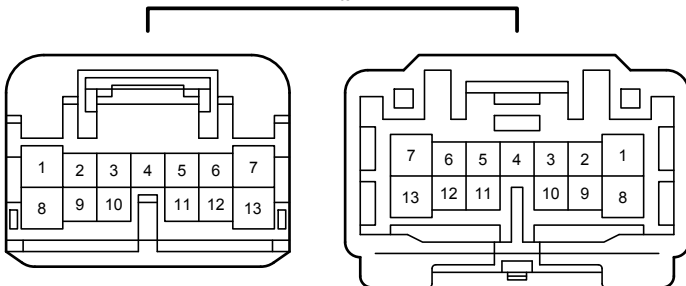

90980-12767

90980-12766

BA1

Blue

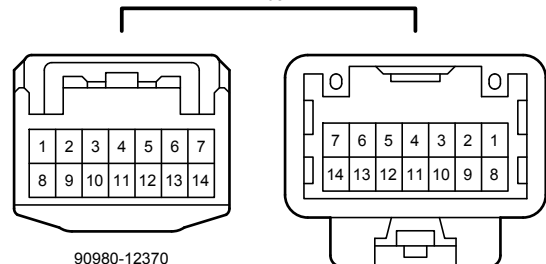

90980-12370

90980-12369