

Double Locking (From Oct. 2015 Production)

G187
Double Lock Door Control Relay Assembly

G115(A), G116(B)
No. 27 Junction Connector

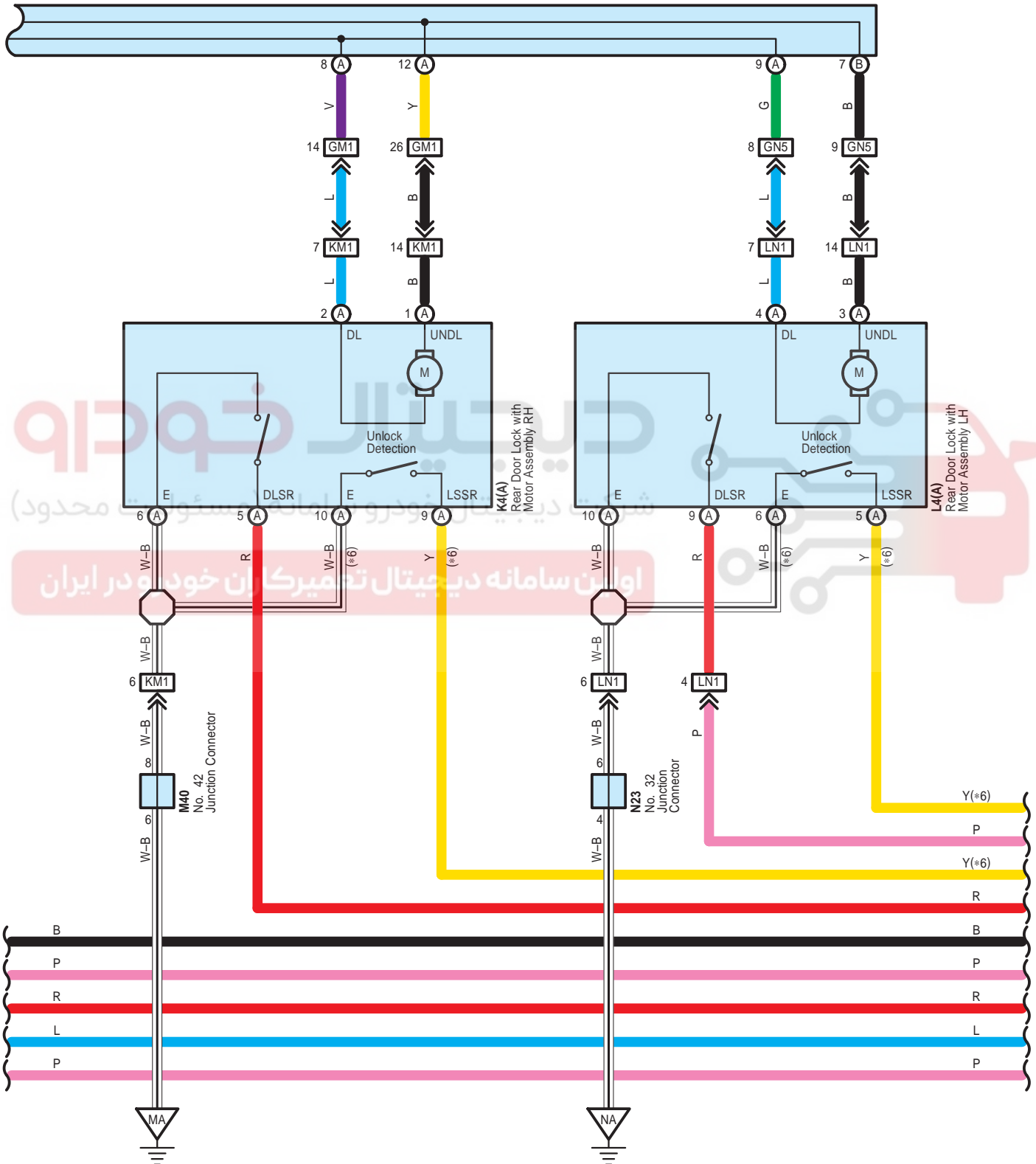

Double Locking (From Oct. 2015 Production)

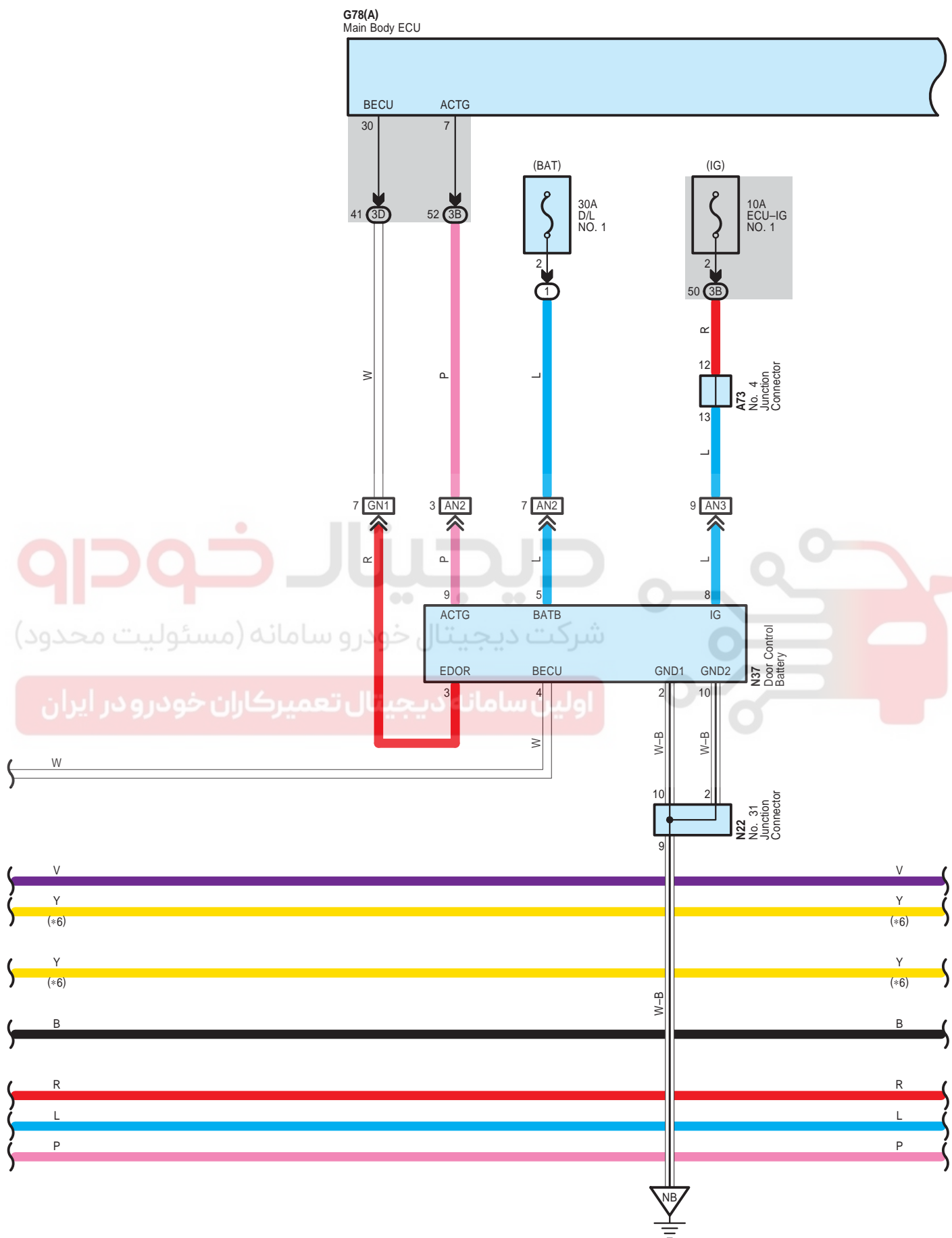

Double Locking (From Oct. 2015 Production)

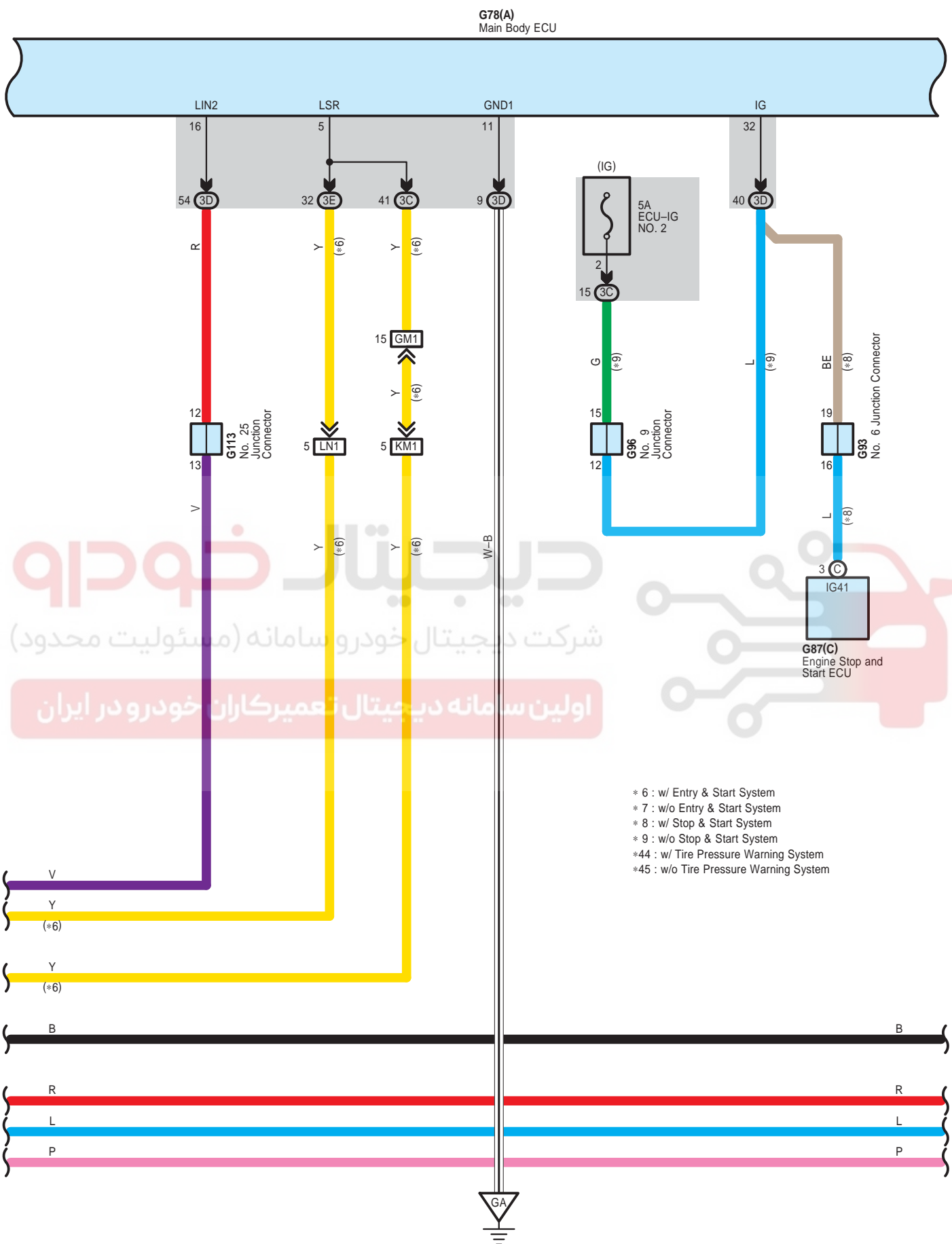

Double Locking (From Oct. 2015 Production)

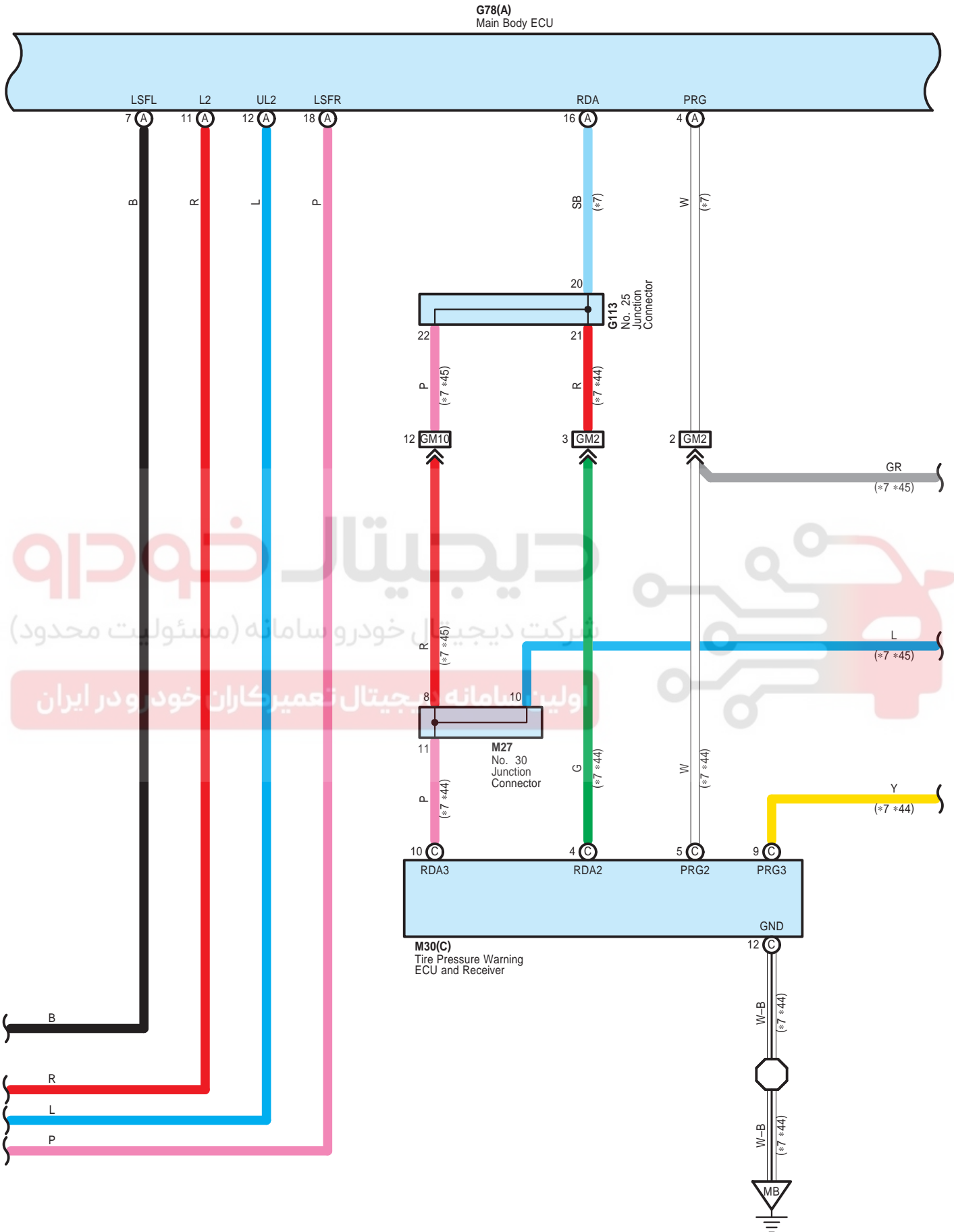

Double Locking (From Oct. 2015 Production)

G78(A)
Main Body ECU

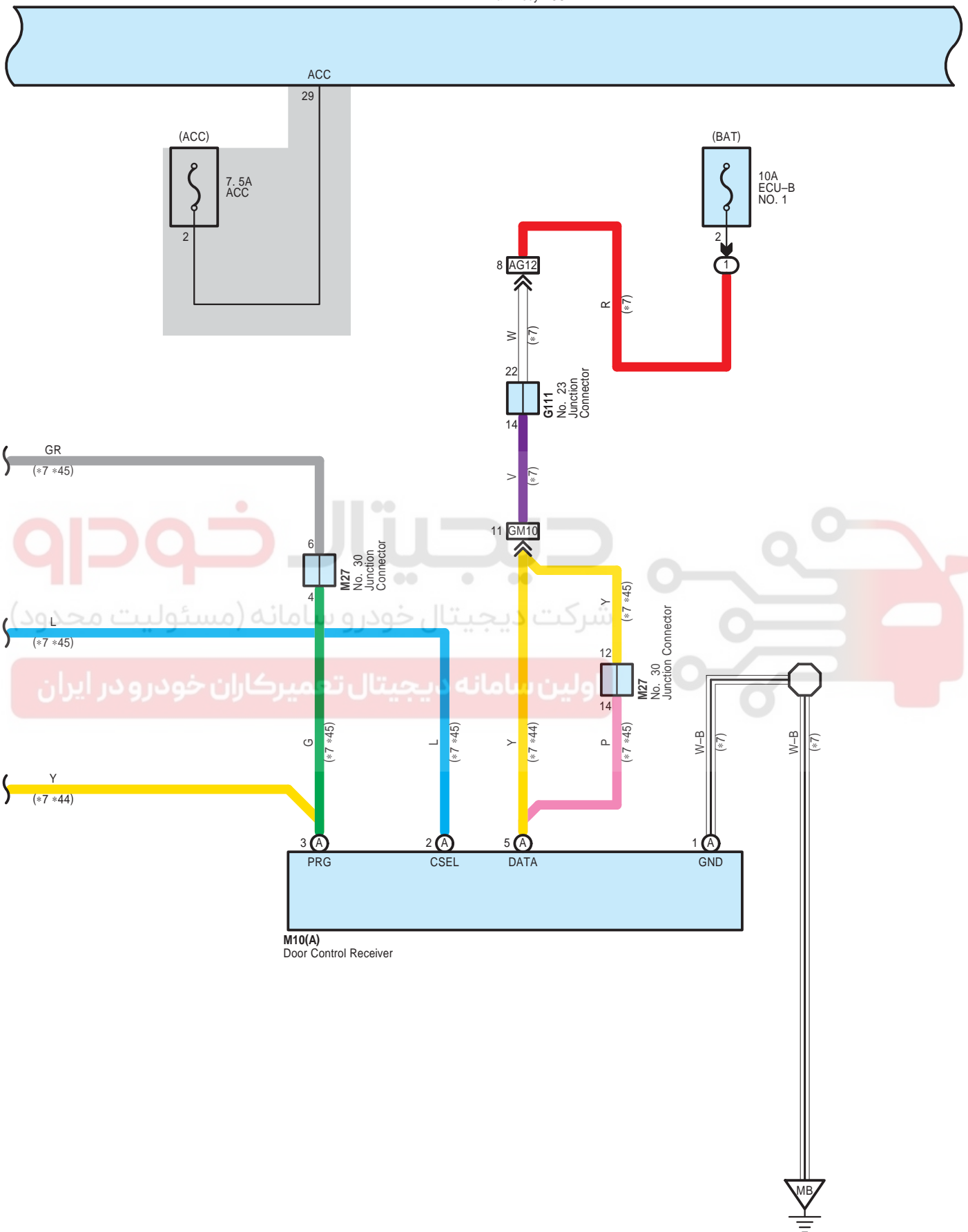

Double Locking (From Oct. 2015 Production)

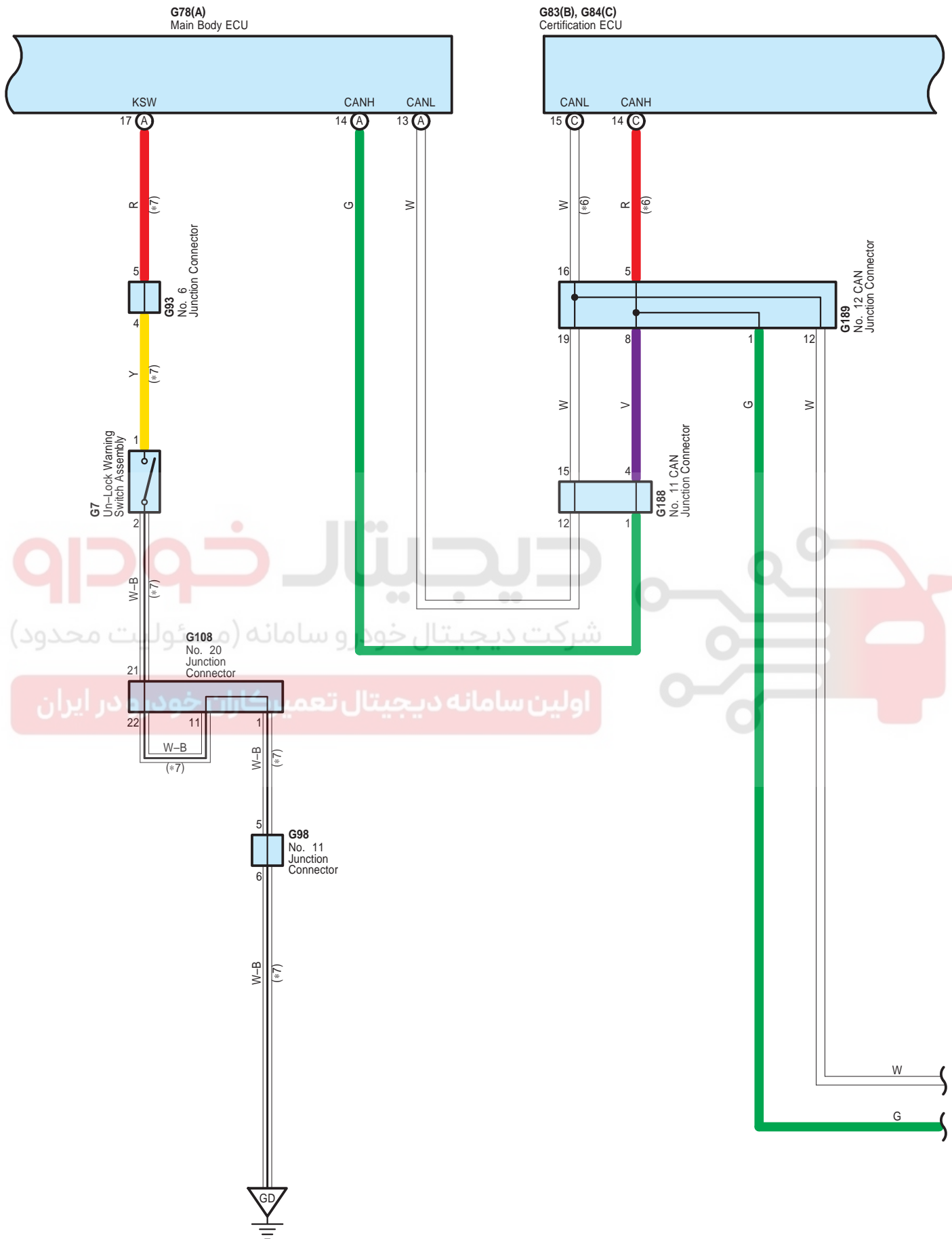

Double Locking (From Oct. 2015 Production)

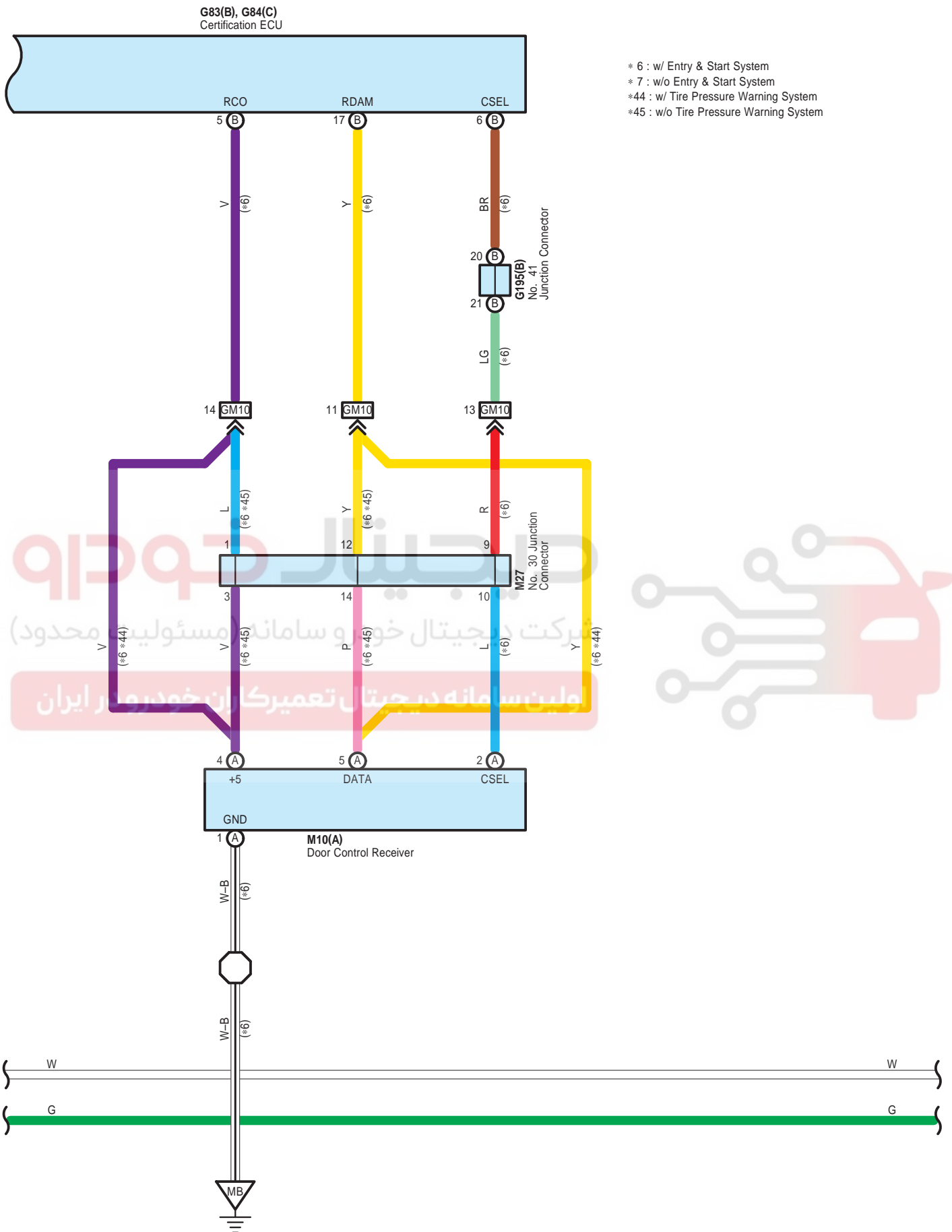

Double Locking (From Oct. 2015 Production)

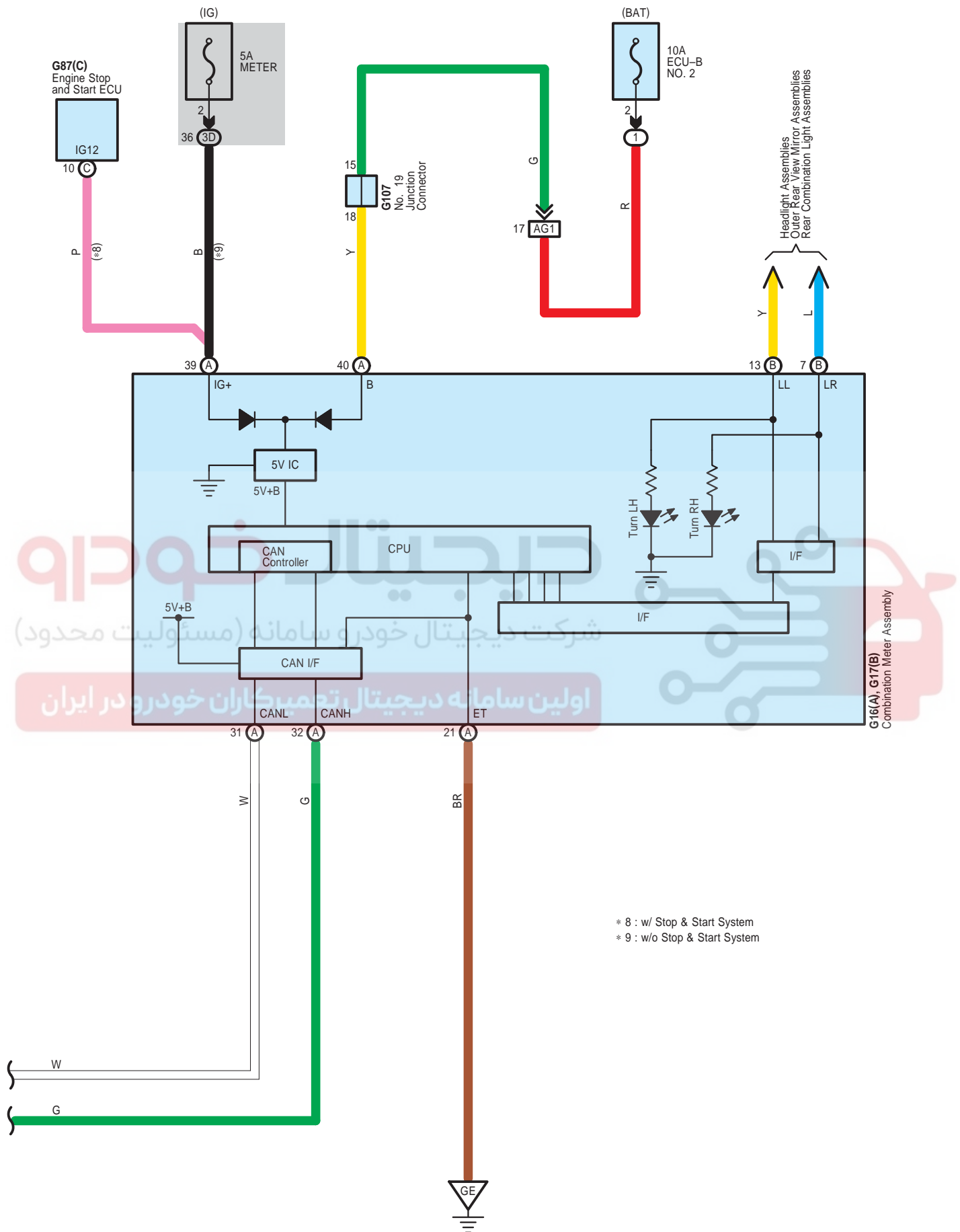

Double Locking (From Oct. 2015 Production)

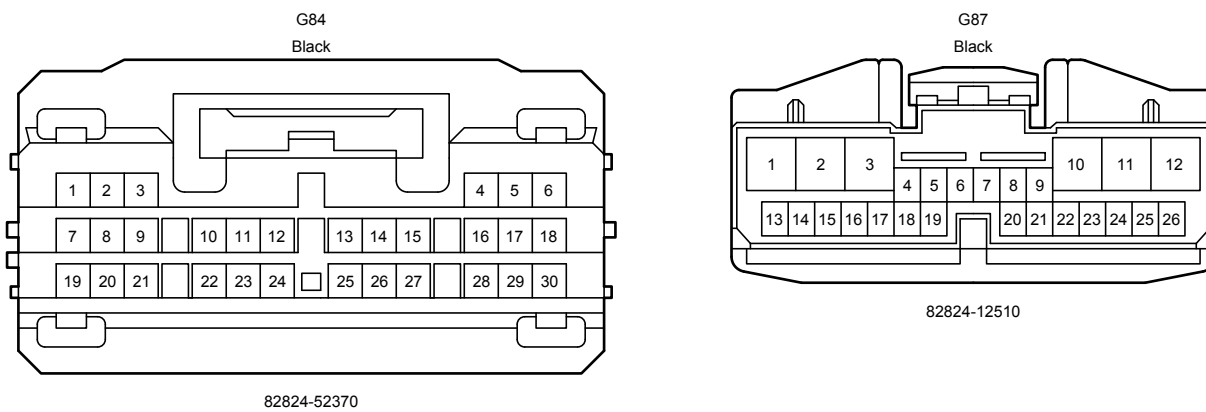
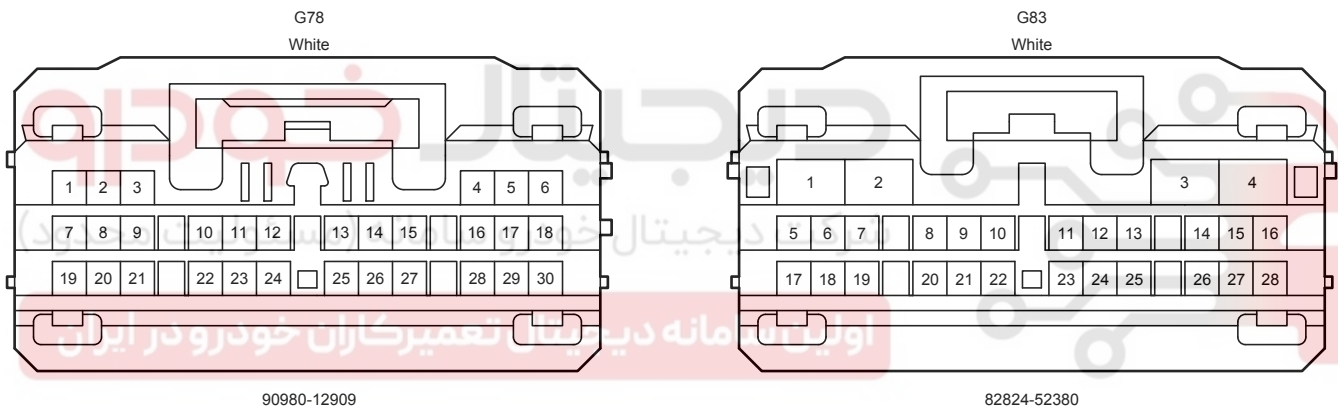
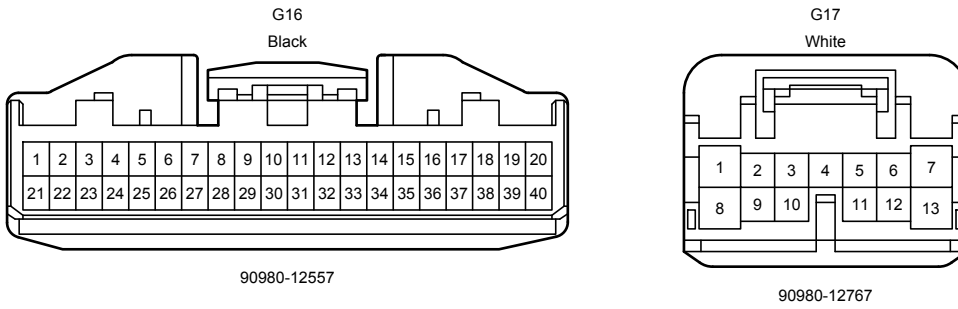
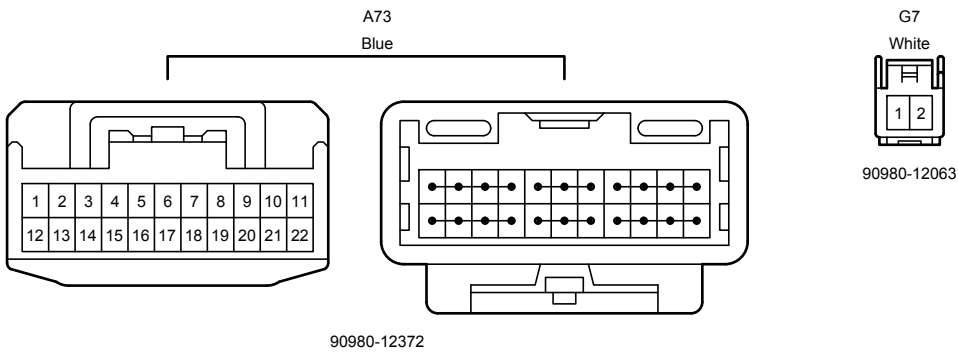

Double Locking (From Oct. 2015 Production)

G93
White

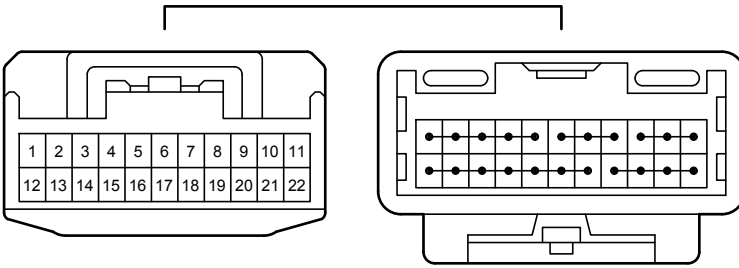

90980-12372

G96
White

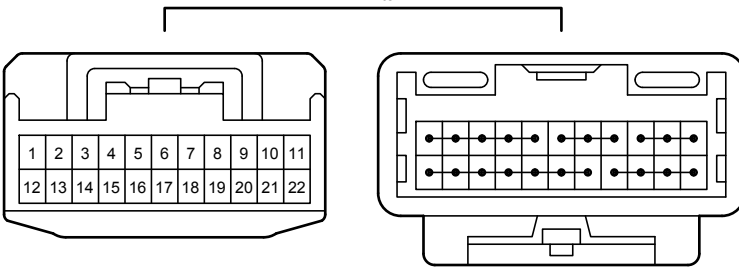

90980-12372

G98
Gray

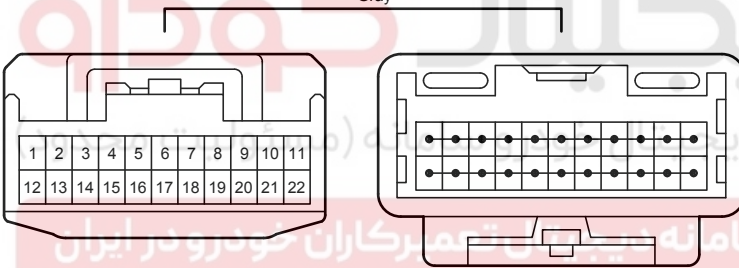

90980-12372

G107
Gray

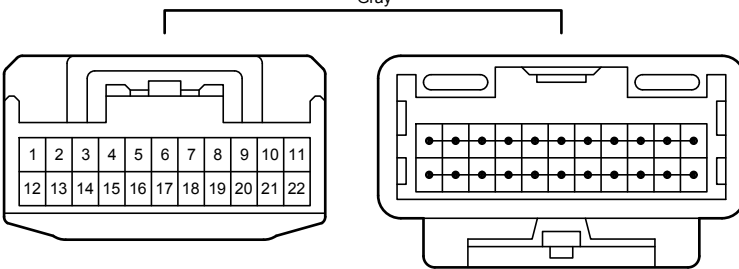

90980-12372



Double Locking (From Oct. 2015 Production)

G108
Gray

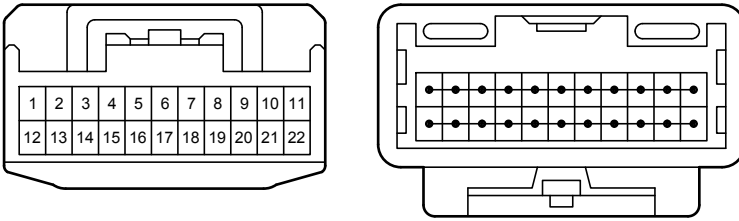

90980-12372

G111
Gray

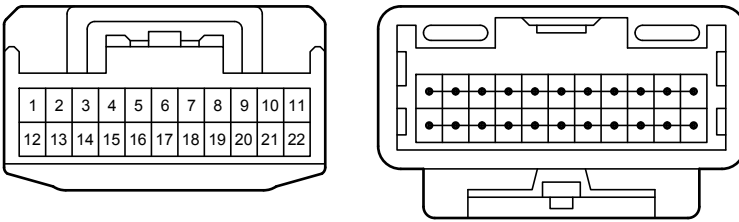

90980-12372

G113
Blue

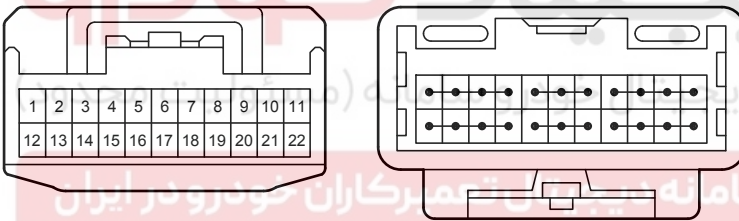

90980-12372

G115
Black

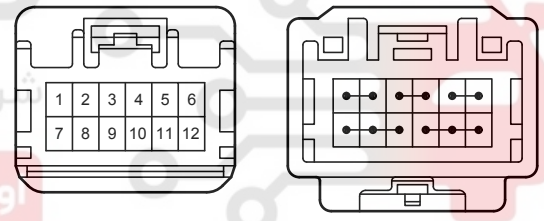

90980-12737

G116
Black

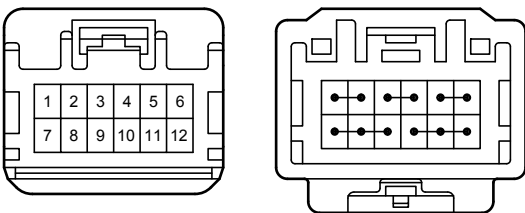

90980-12737

G187
White

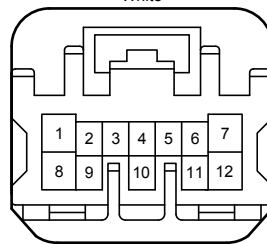

90980-12812

Double Locking (From Oct. 2015 Production)

G188
Gray

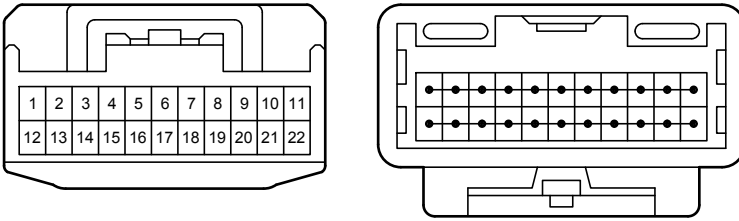

90980-12372

G189
Gray

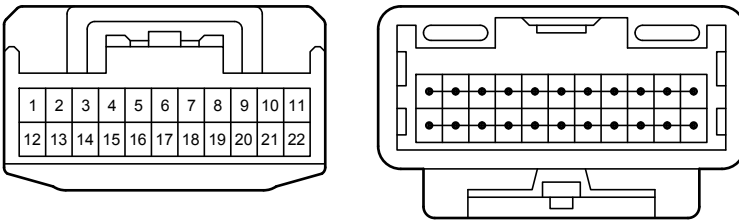

90980-12372

G195
Blue

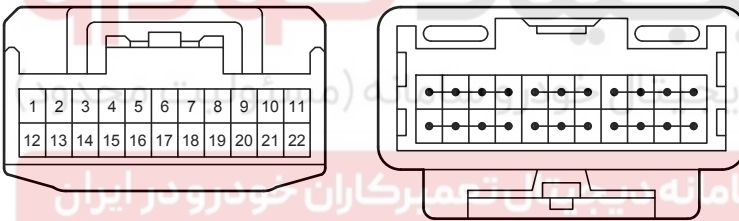

90980-12372

I10
White



90980-12226

J10
White



90980-12226

K4

White

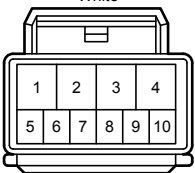

90980-12226

L4

White

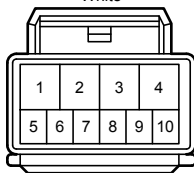

90980-12226

M4

Black



90980-10871

M6

Black



90980-10871

M10

White

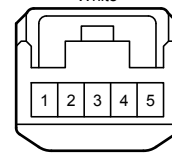

90980-12366

Double Locking (From Oct. 2015 Production)

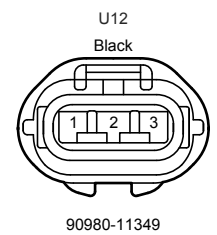
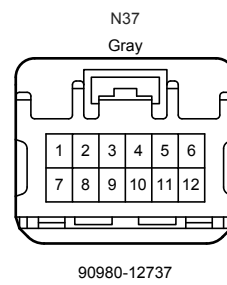
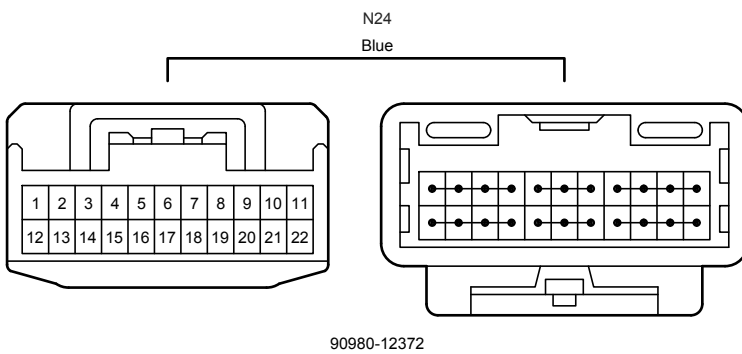
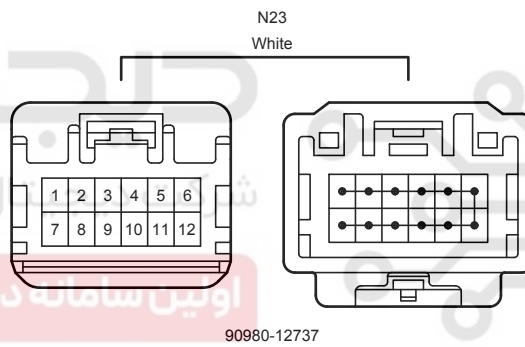
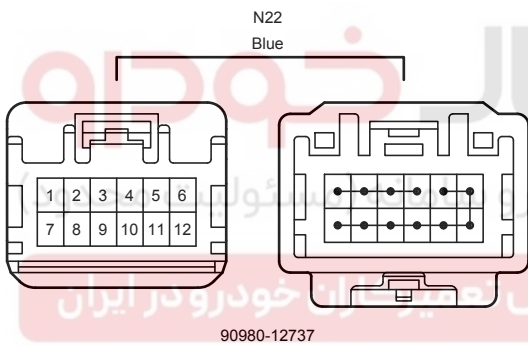
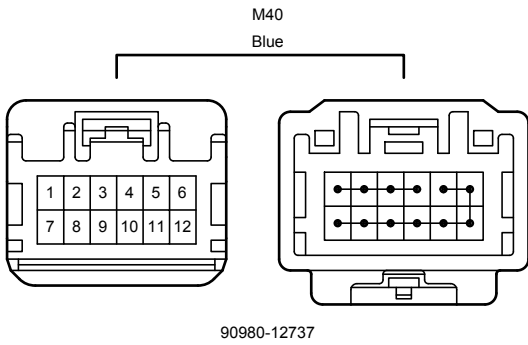
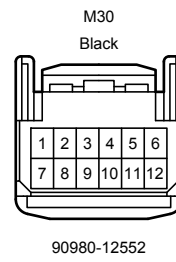
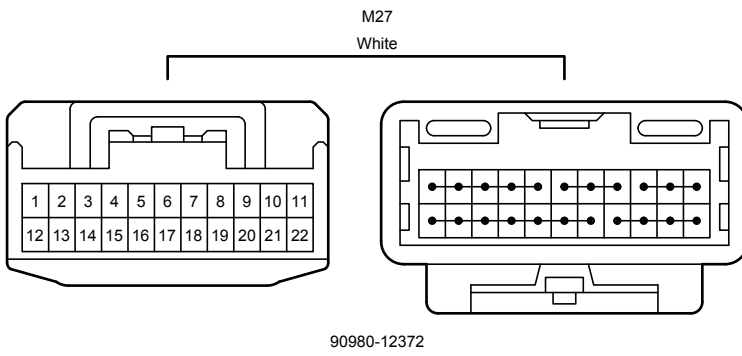

Double Locking (From Oct. 2015 Production)

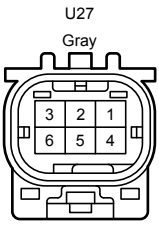

90980-12A80

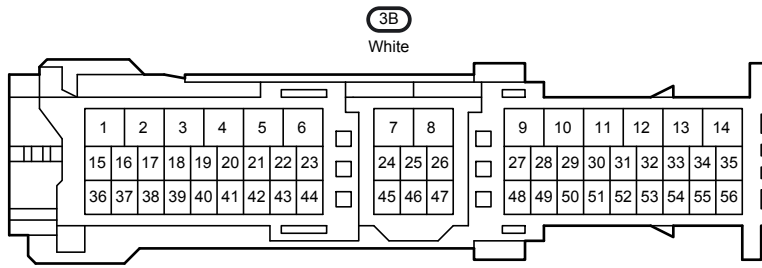

90980-12A15

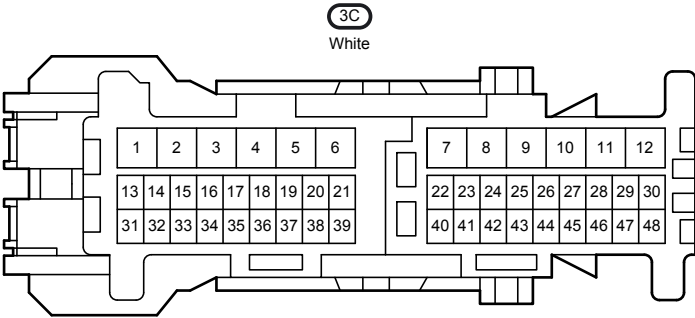

90980-12887

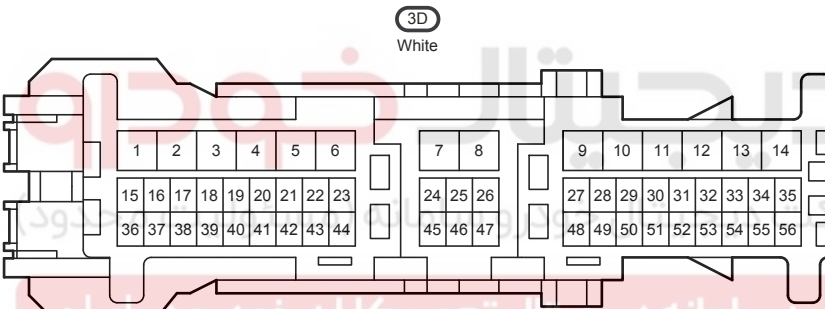

90980-12890

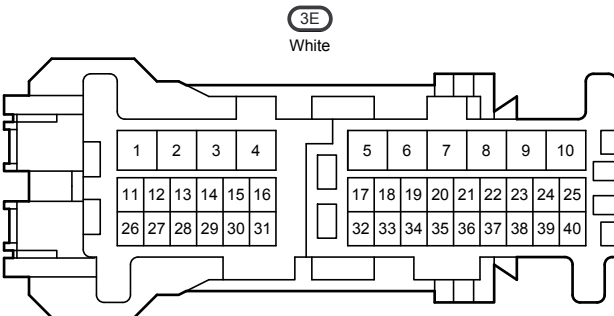

90980-12884



Double Locking (From Oct. 2015 Production)

AG1
Blue

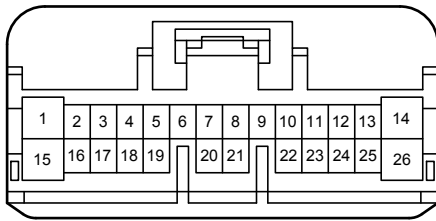

90980-12771

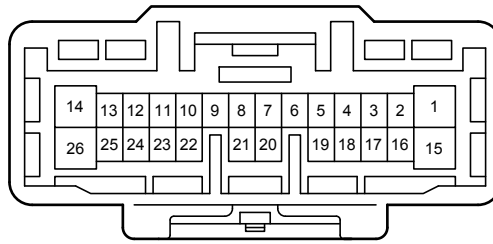

90980-12770

AG12
Blue

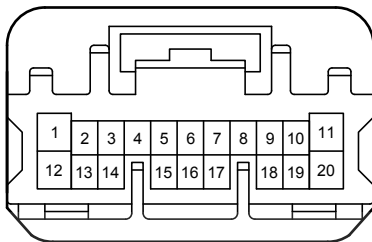

90980-12741

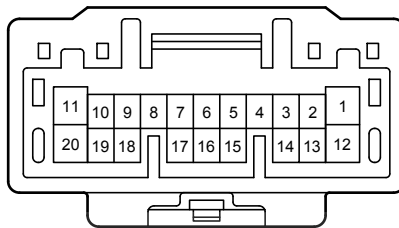

90980-12740

AN2
White

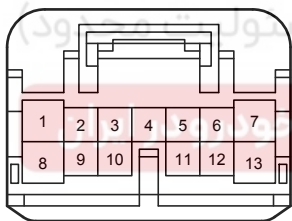

90980-12767

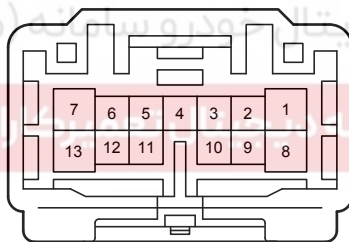

90980-12766

AN3
Blue

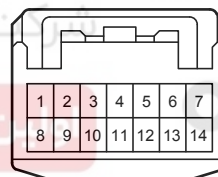

90980-12370

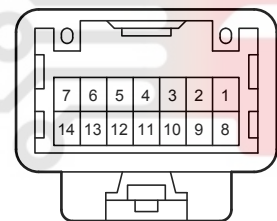

90980-12369

GM1
White

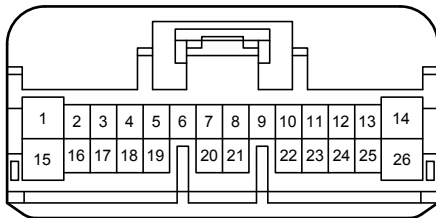

90980-12771

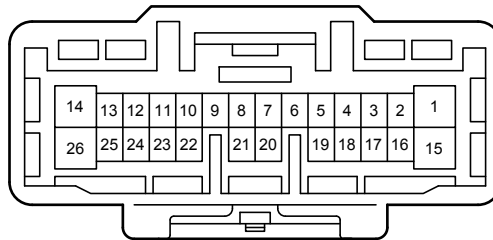

90980-12770

Double Locking (From Oct. 2015 Production)

GM2
Blue

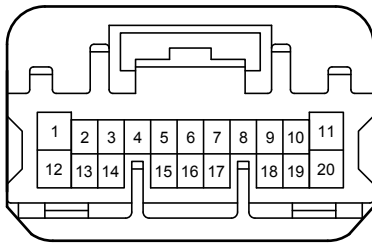

90980-12741

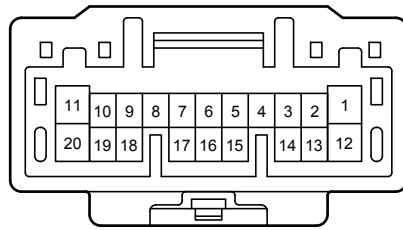

90980-12740

GM8
Gray

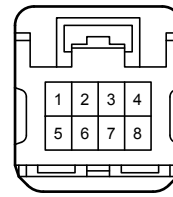

90980-12735

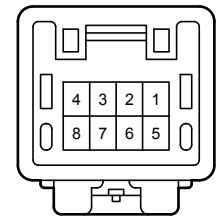

90980-12734

GM10
Gray

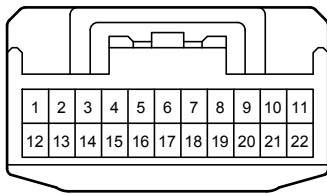

90980-12372

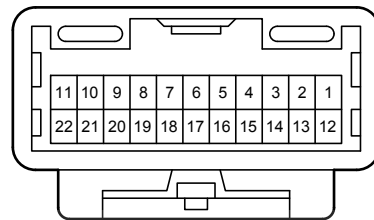

90980-12371

GN1
White

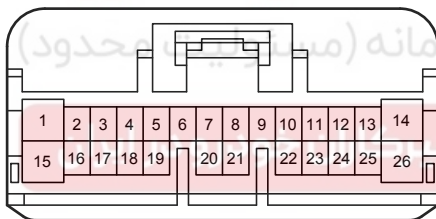

90980-12771

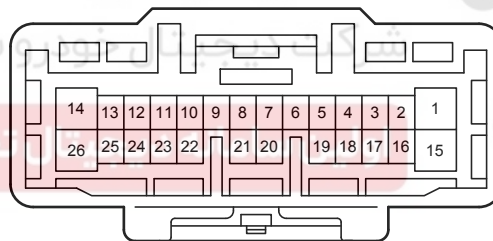

90980-12770

GN2
Blue

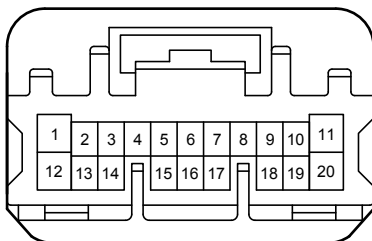

90980-12741

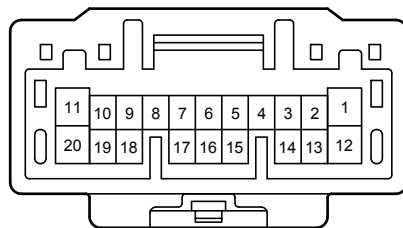

90980-12740

Double Locking (From Oct. 2015 Production)

GN5
Black

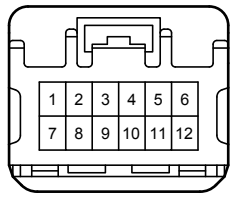

90980-12737

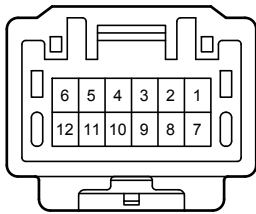

90980-12736

IG2
White

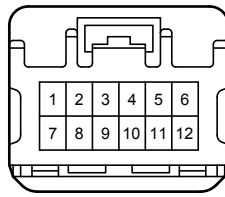

90980-12737

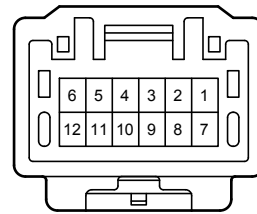

90980-12736

IG3
Black

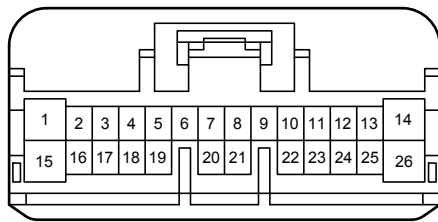

90980-12771

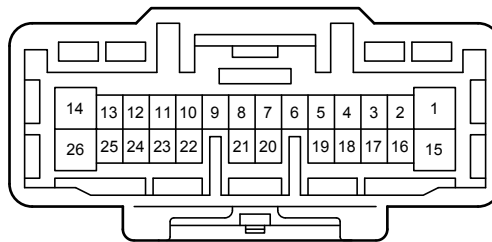

90980-12770

IG4
Gray

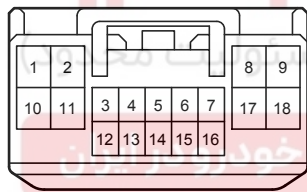

90980-12A21

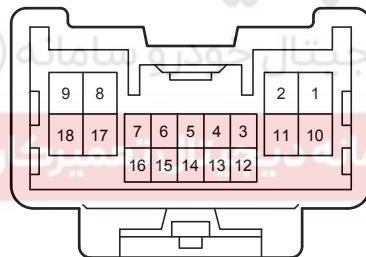

90980-12546

JG2
White

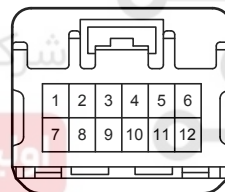

90980-12737

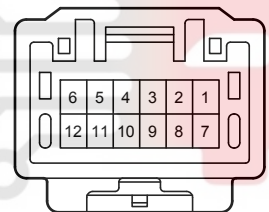

90980-12736

JG3
Black

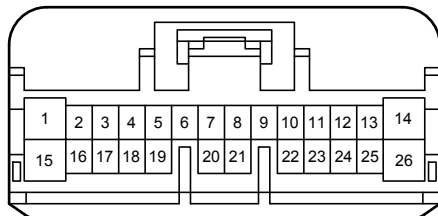

90980-12771

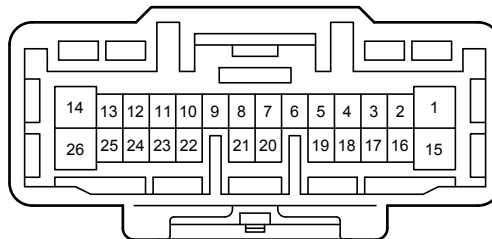

90980-12770

Double Locking (From Oct. 2015 Production)

JG4
Gray

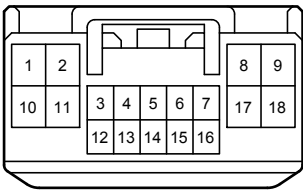

90980-12A21

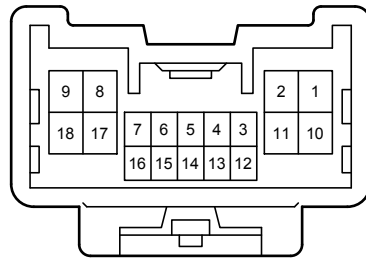

90980-12546

KM1
White

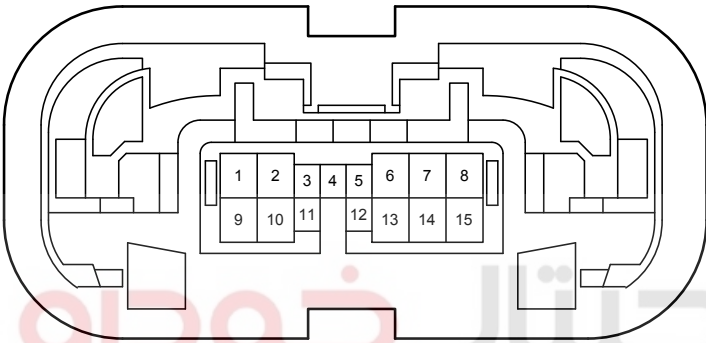

90980-12A01

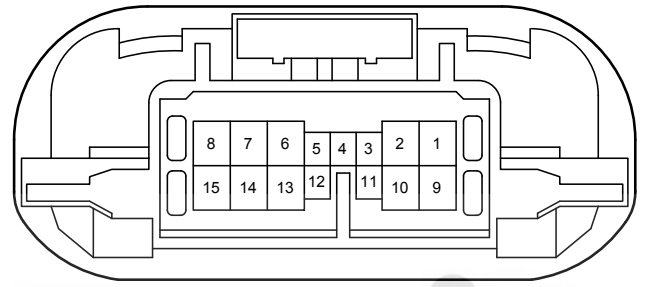

90980-12A00

LN1
White

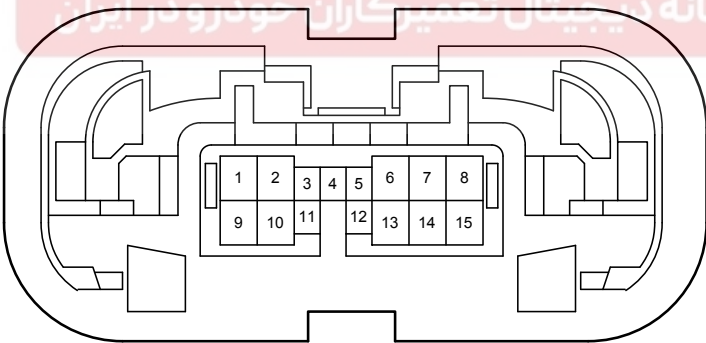

90980-12A01

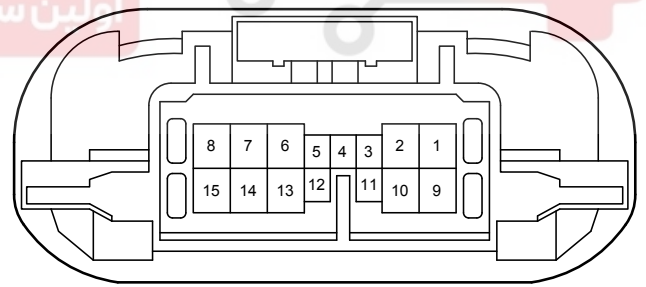

90980-12A00

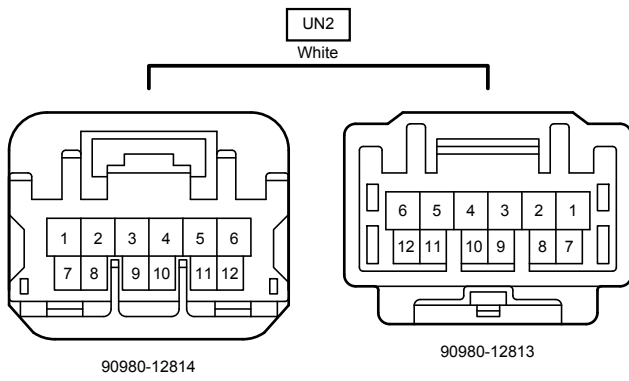

دیجیتال خودرو

شرکت دیجیتال خودرو سامانه (مسئولیت محدود)

اولین سامانه دیجیتال تعمیرکاران خودرو در ایران

