

Cruise Control (2AR-FE) (From Oct. 2015 Production), ECT and A/T Indicator (2AR-FE) (From Oct. 2015 Production), Engine Control (2AR-FE) (From Oct. 2015 Production)

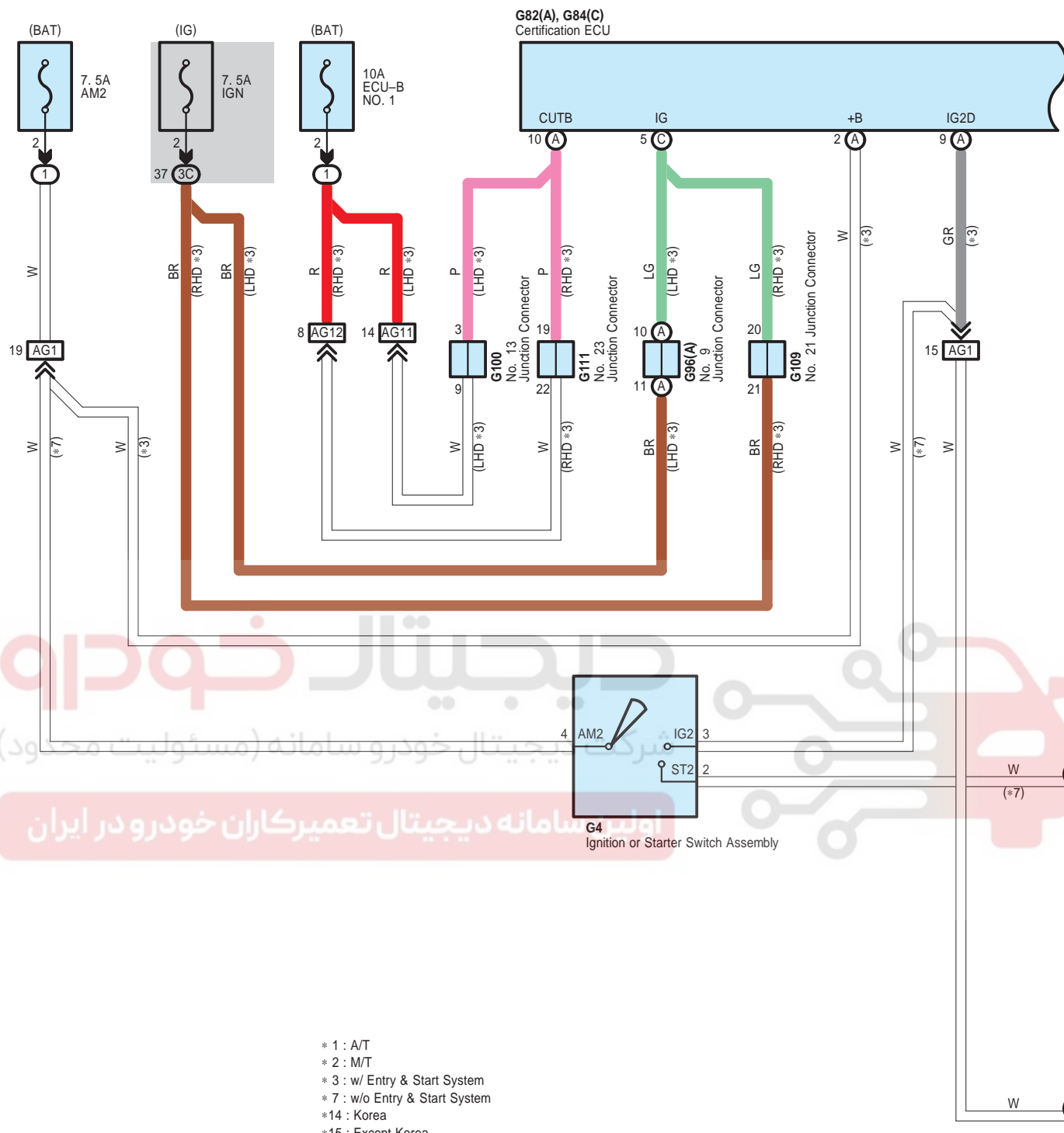

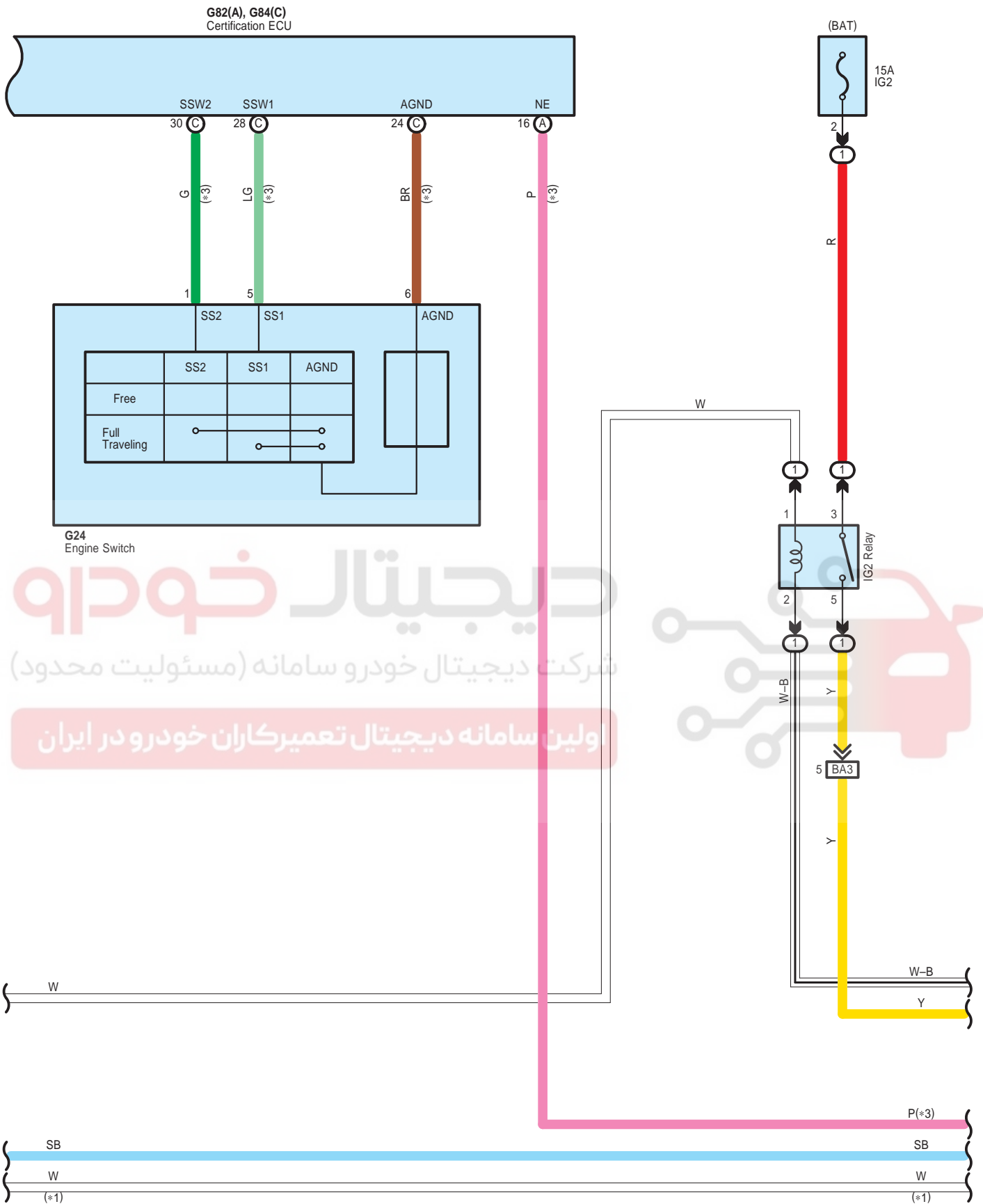

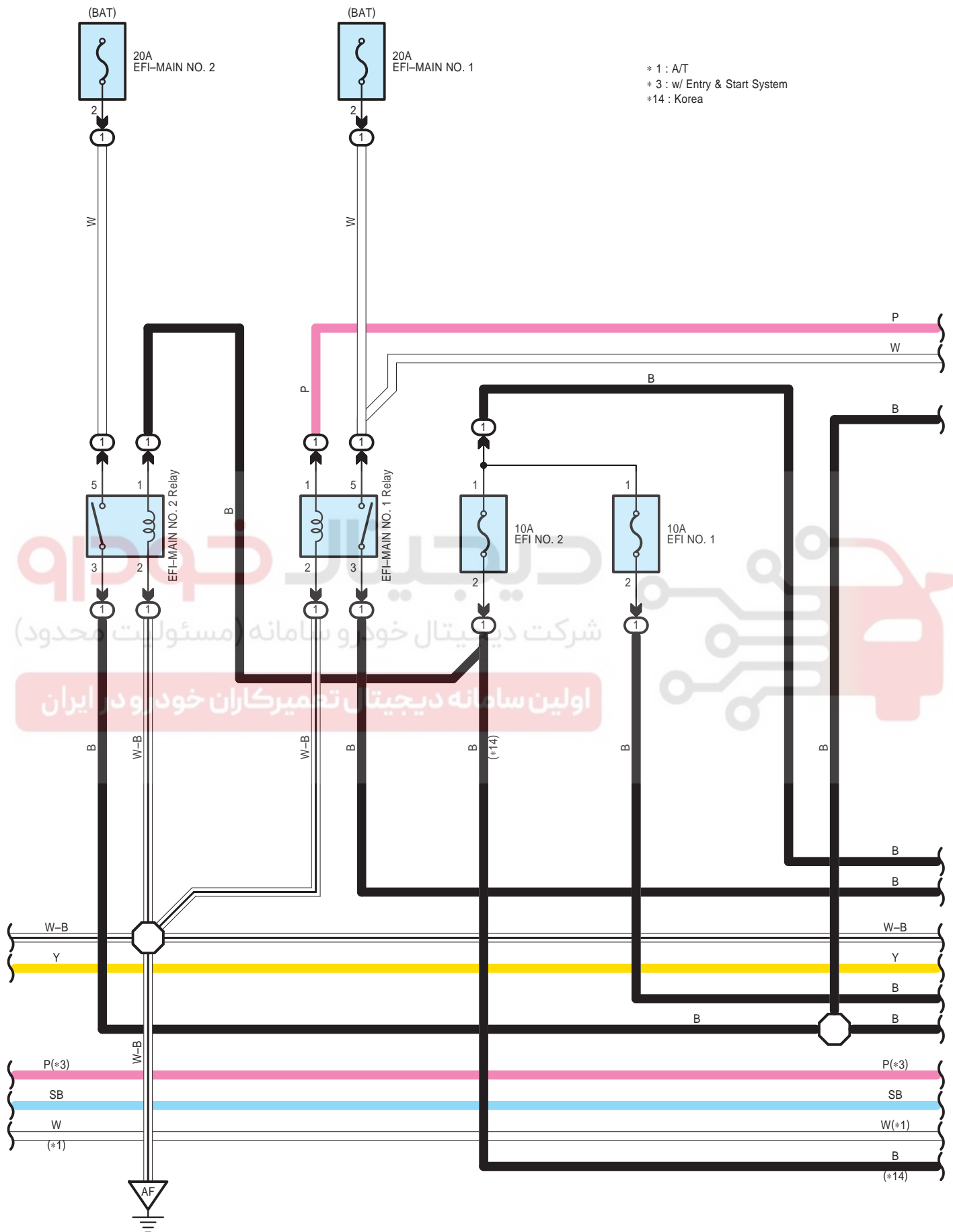

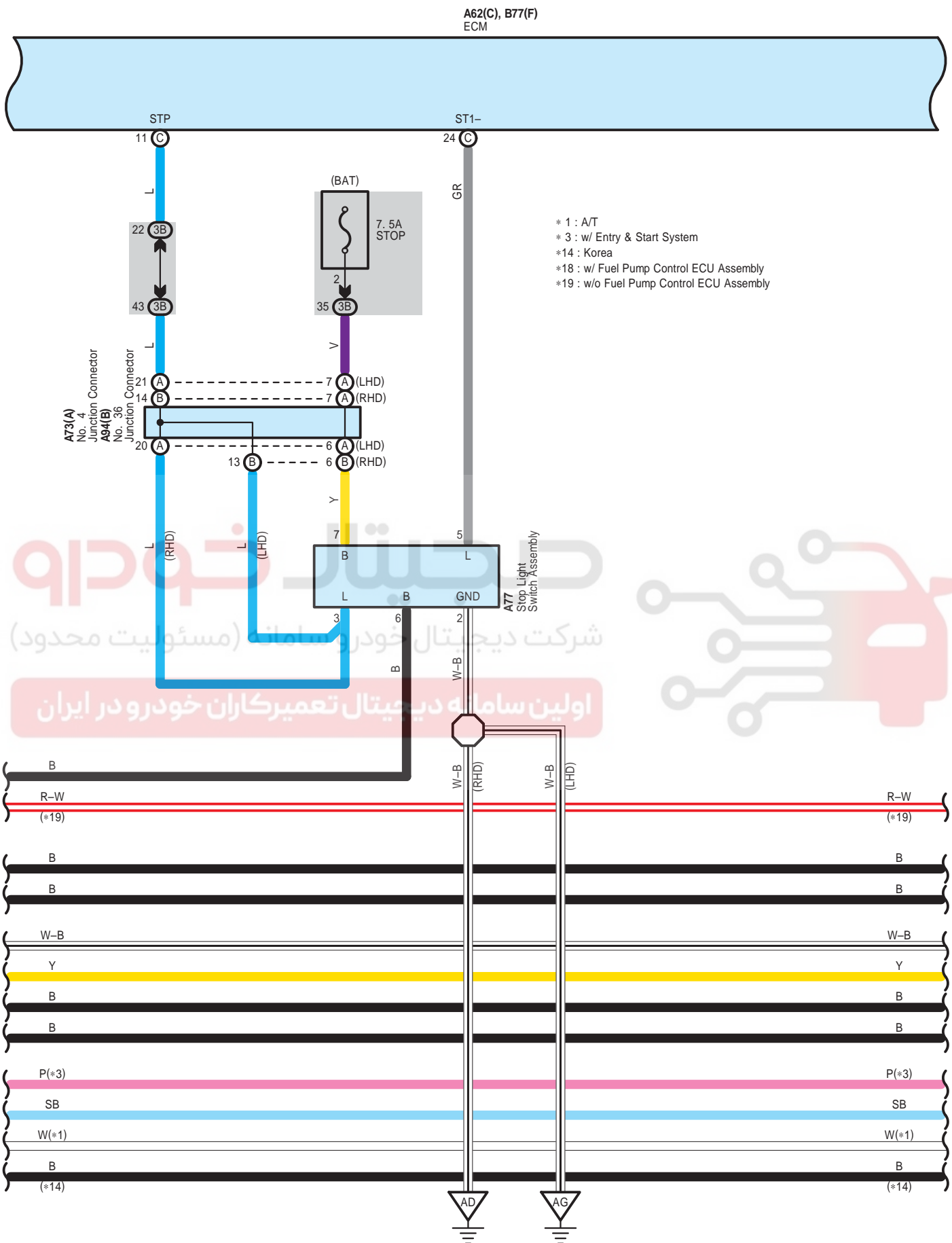

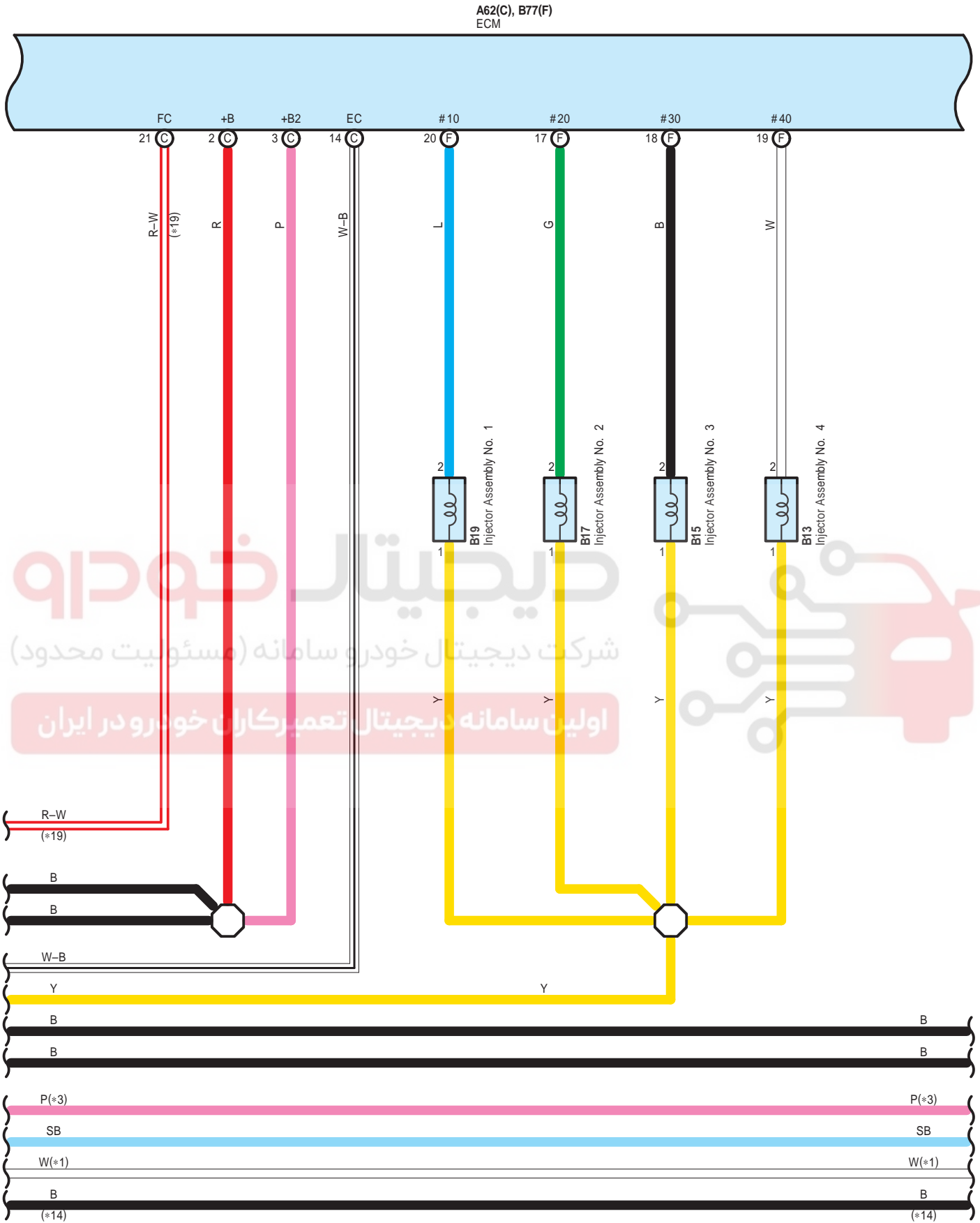

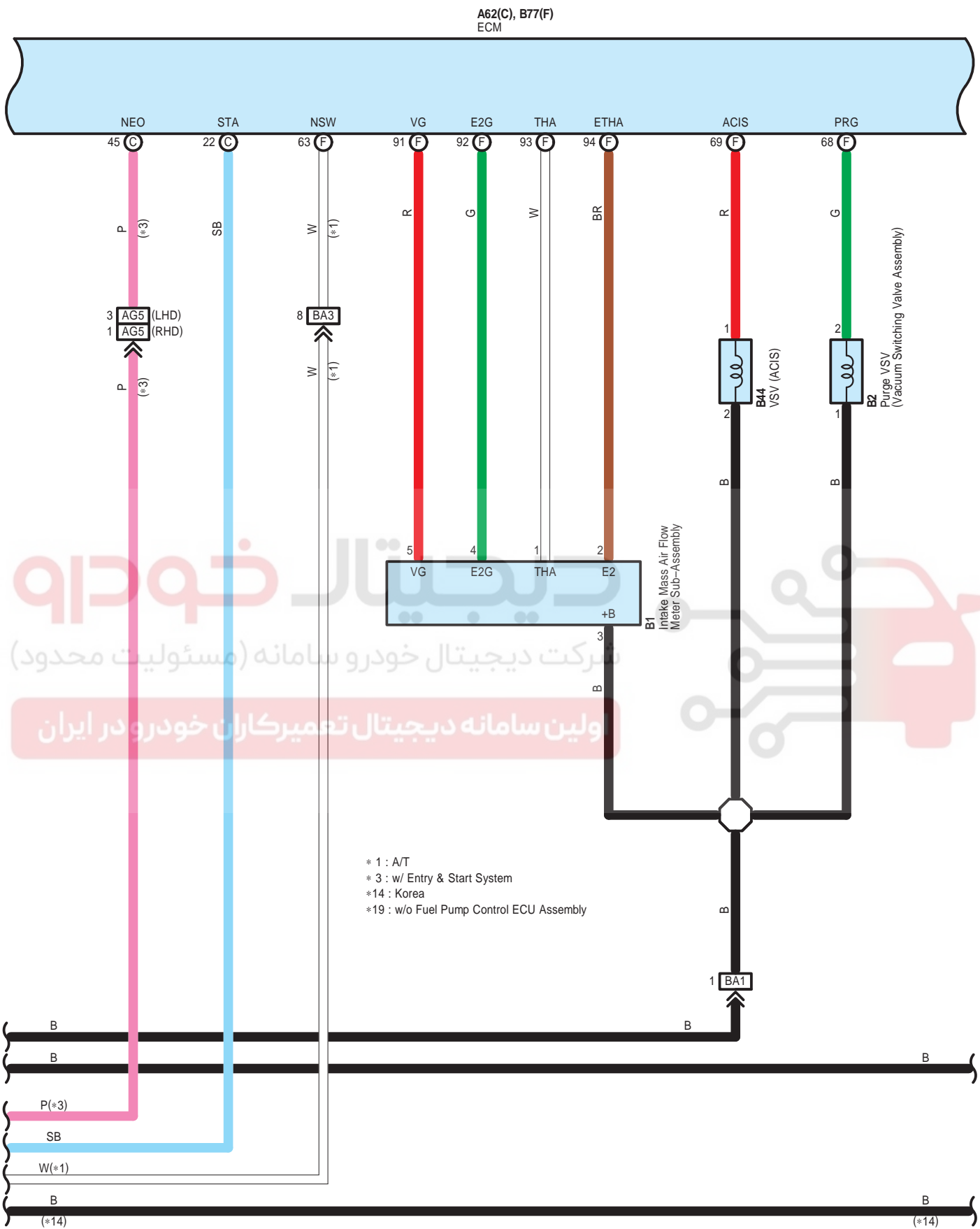

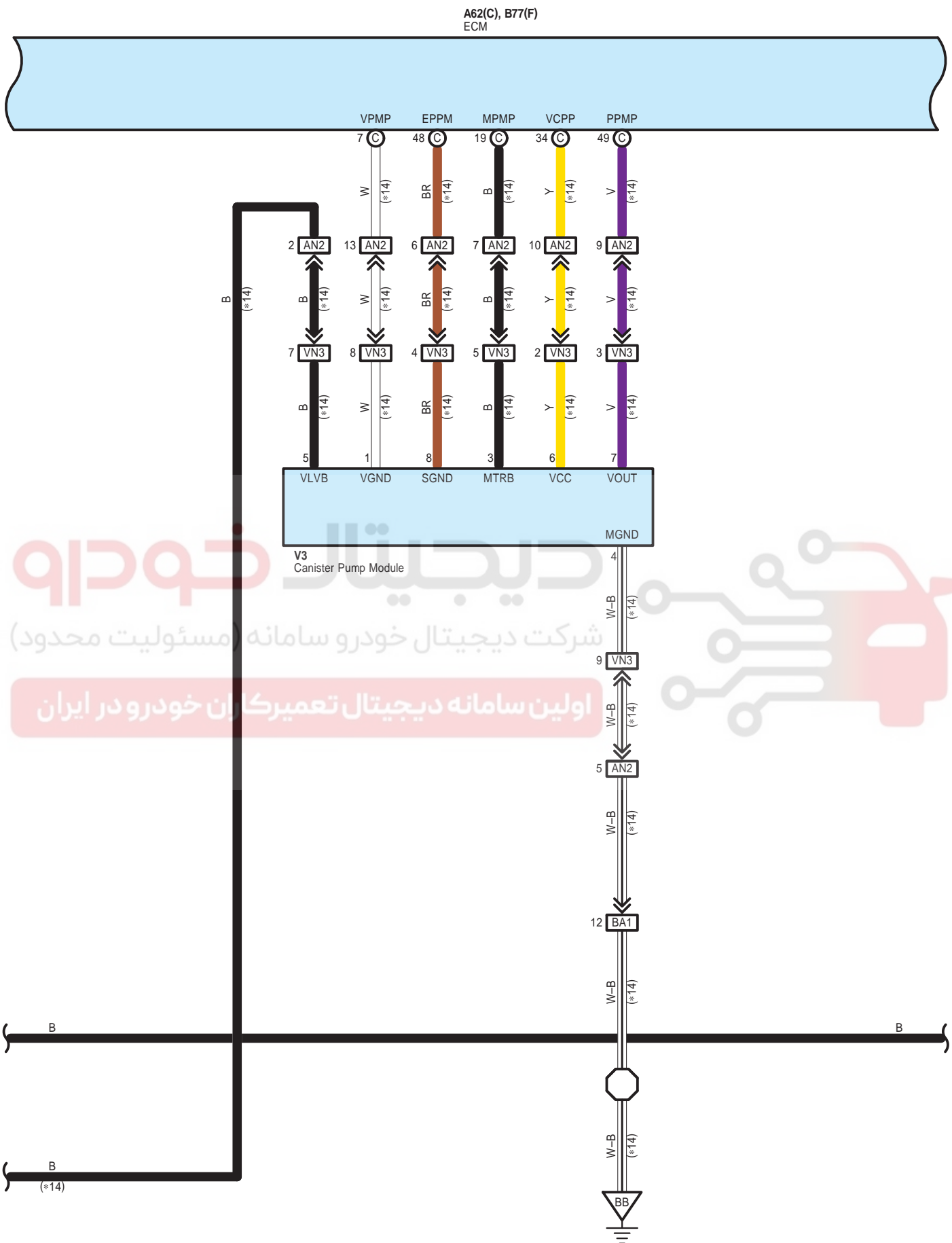

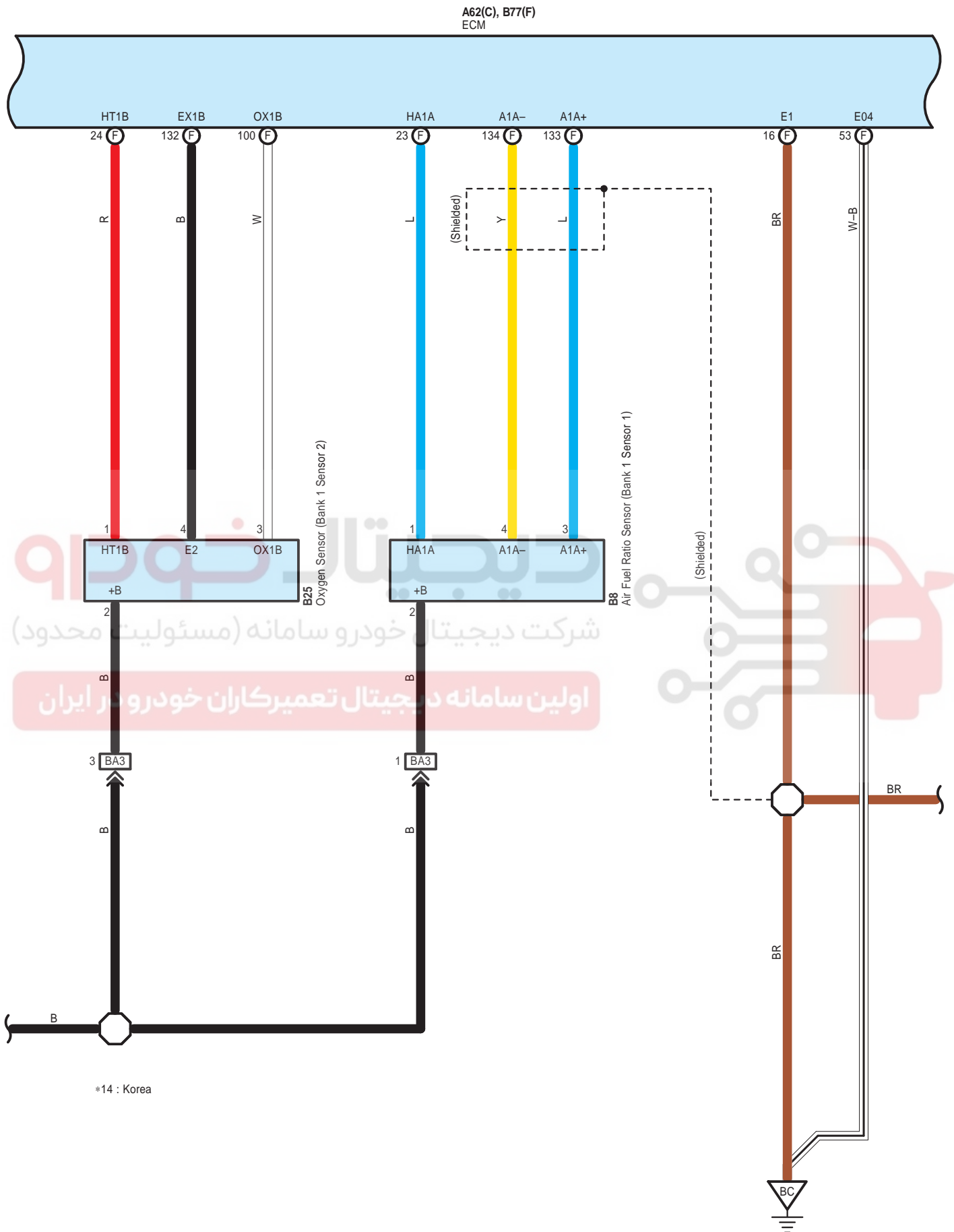

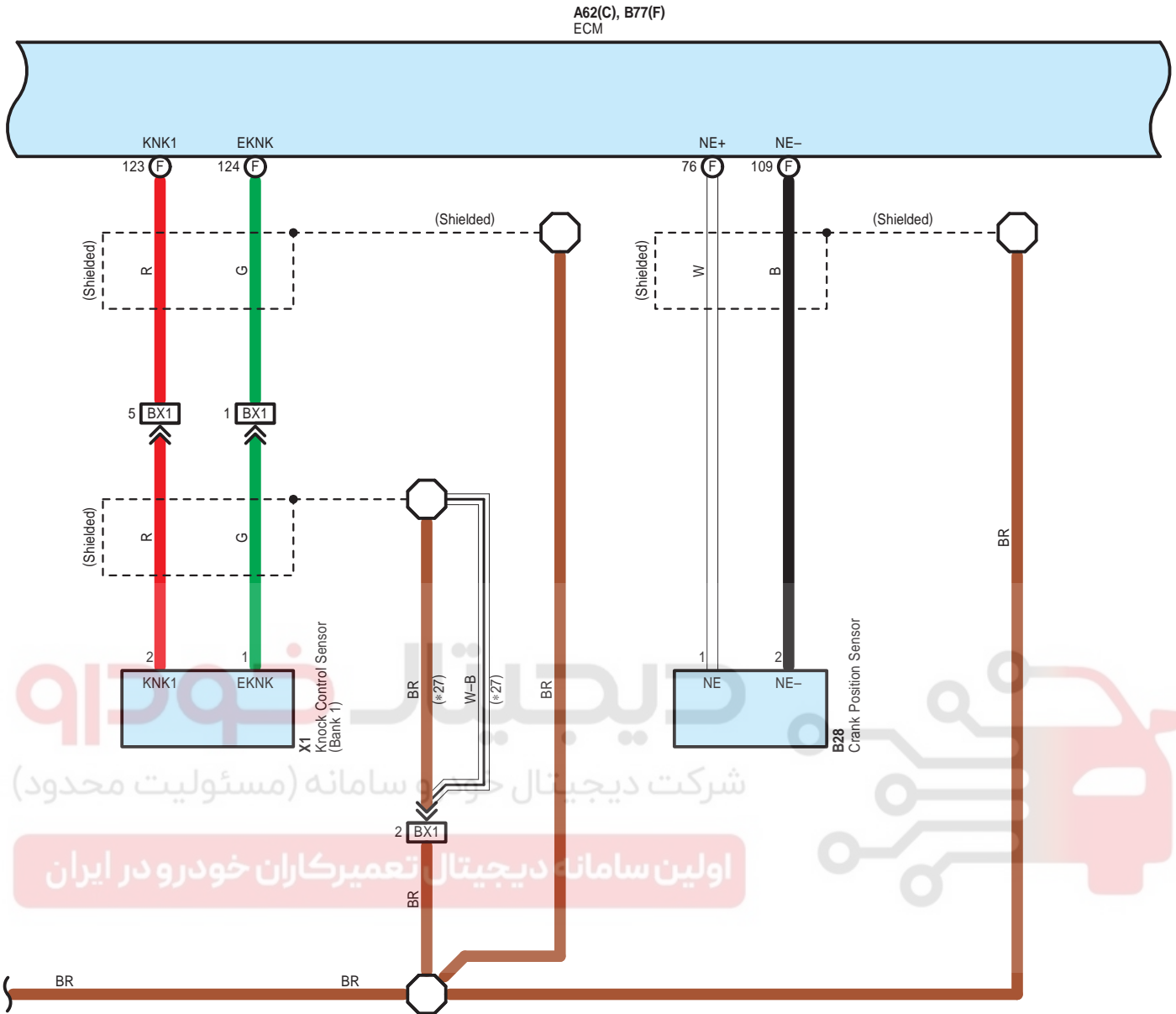

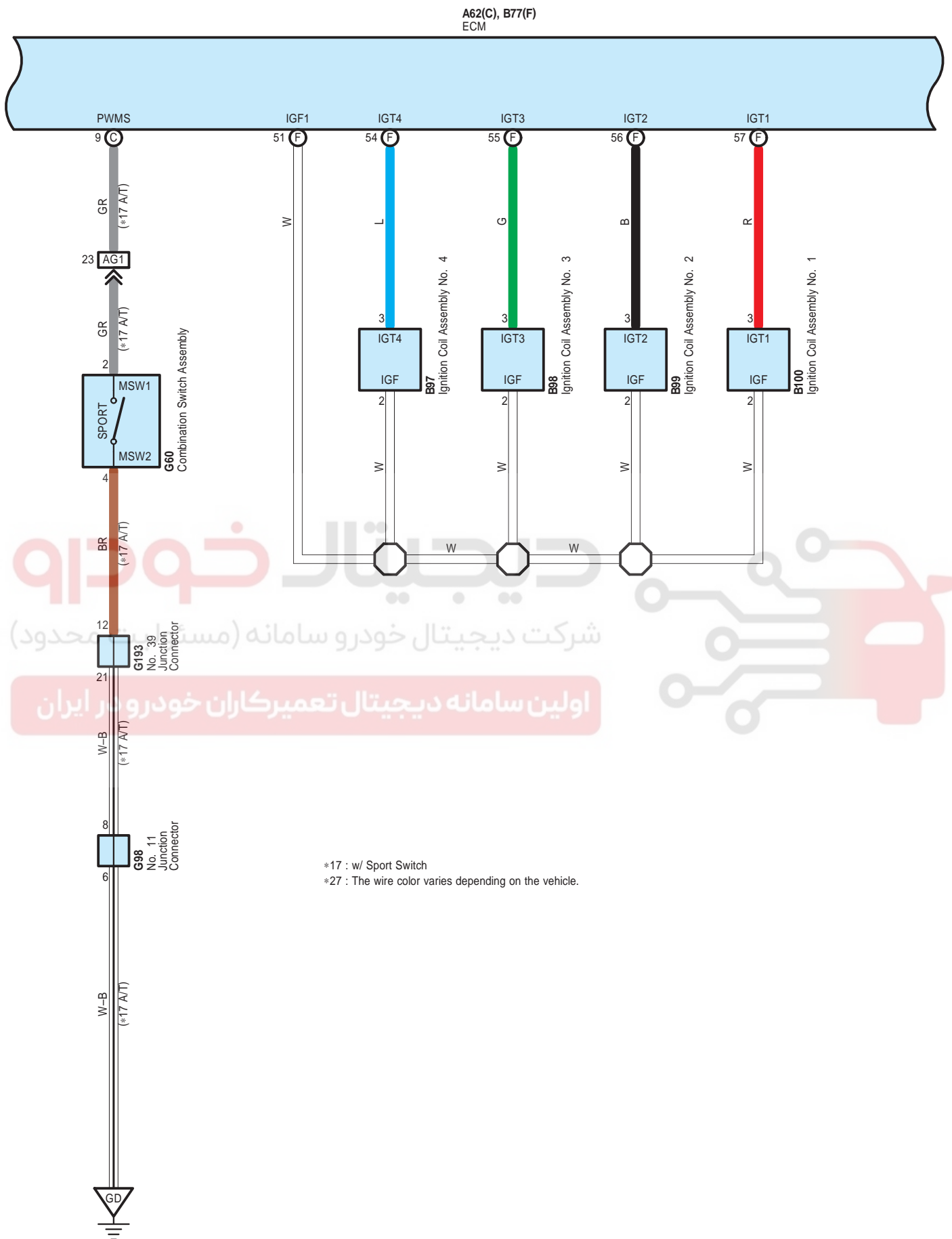

*17 : w/ Sport Switch
 *27 : The wire color varies depending on the vehicle.

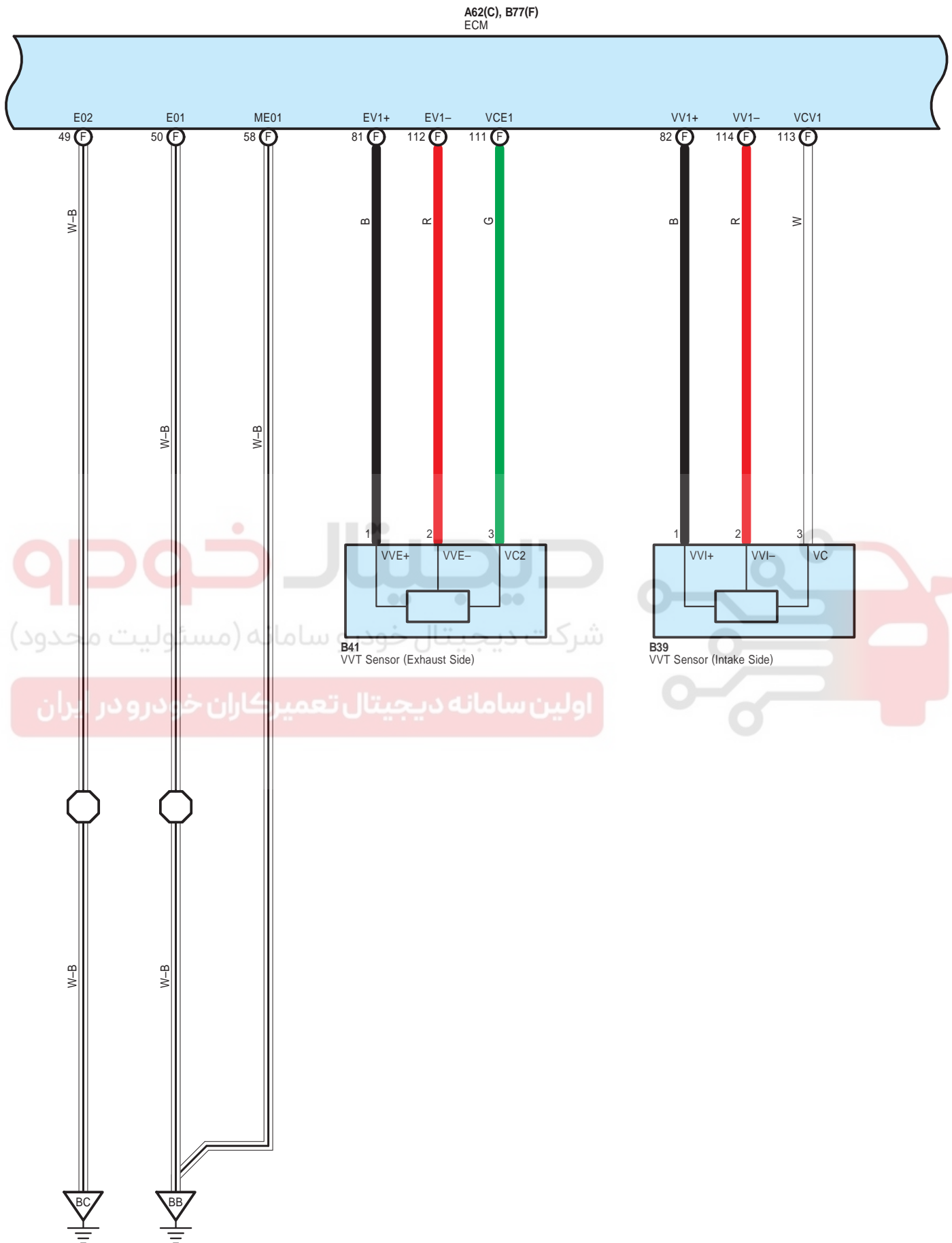

Cruise Control (2AR-FE) (From Oct. 2015 Production), ECT and A/T Indicator (2AR-FE) (From Oct. 2015 Production), Engine Control (2AR-FE) (From Oct. 2015 Production)

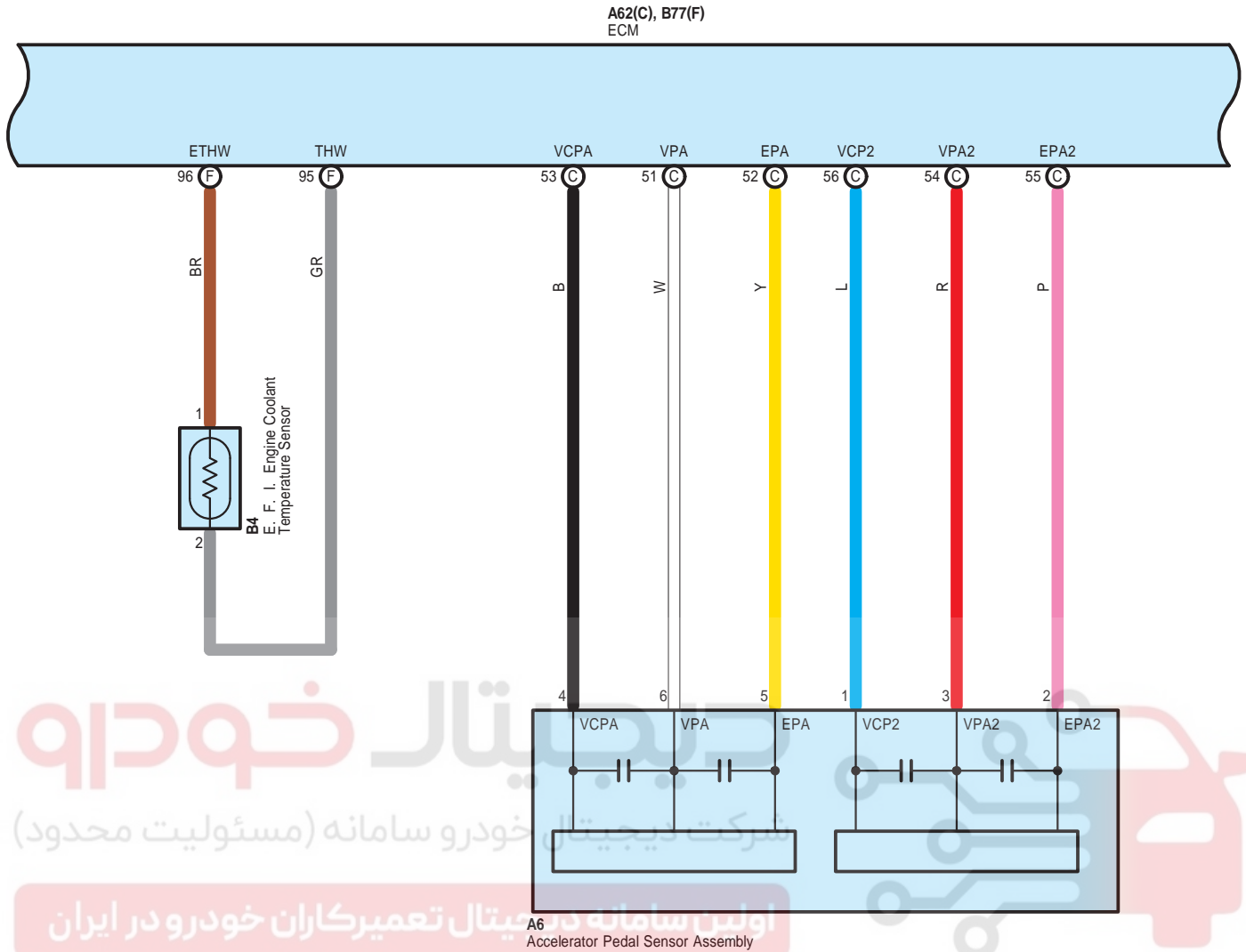

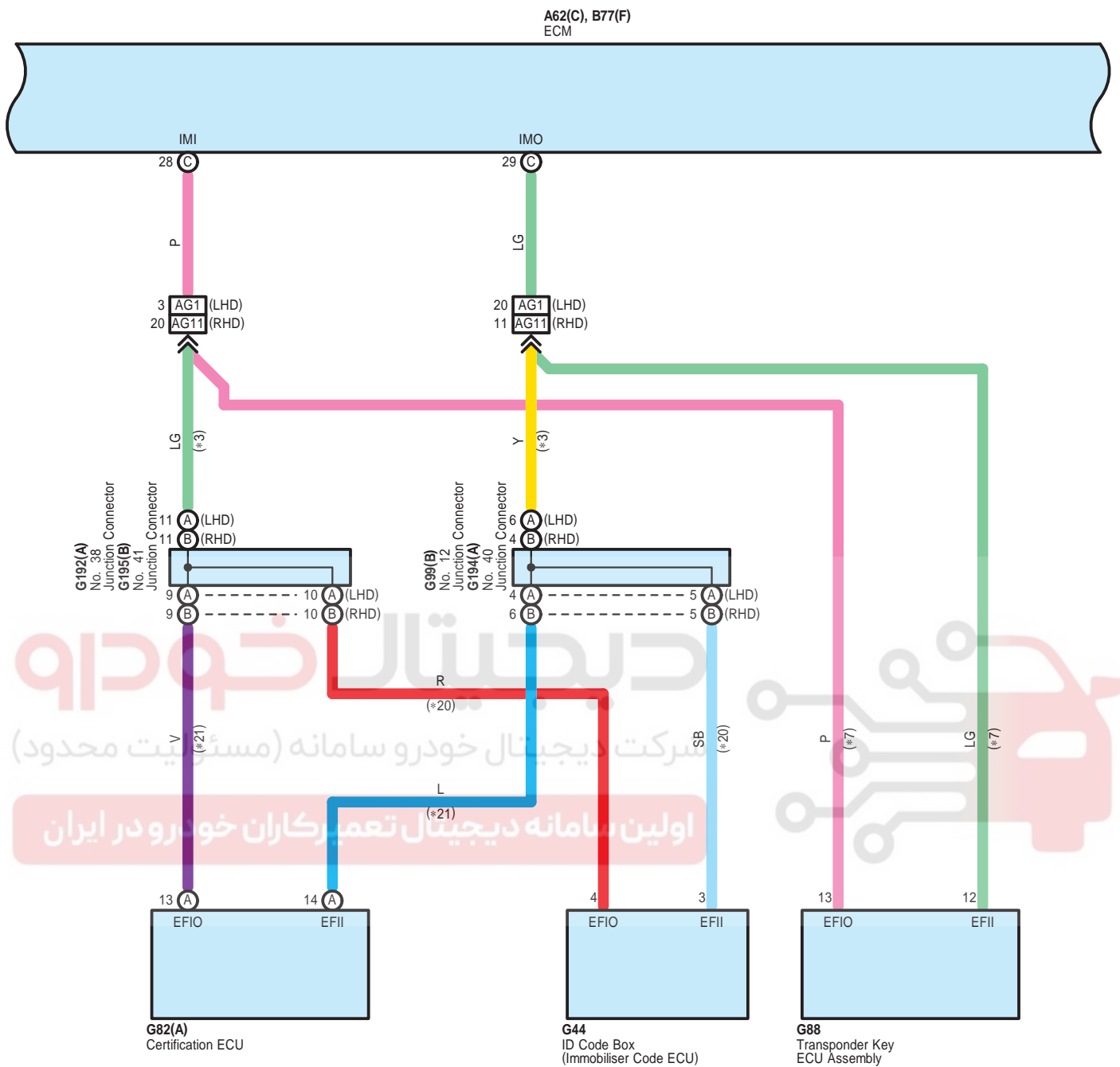

* 3 : w/ Entry & Start System
 * 7 : w/o Entry & Start System
 *20 : w/ Entry & Start System w/ ID Code Box
 *21 : w/ Entry & Start System w/o ID Code Box

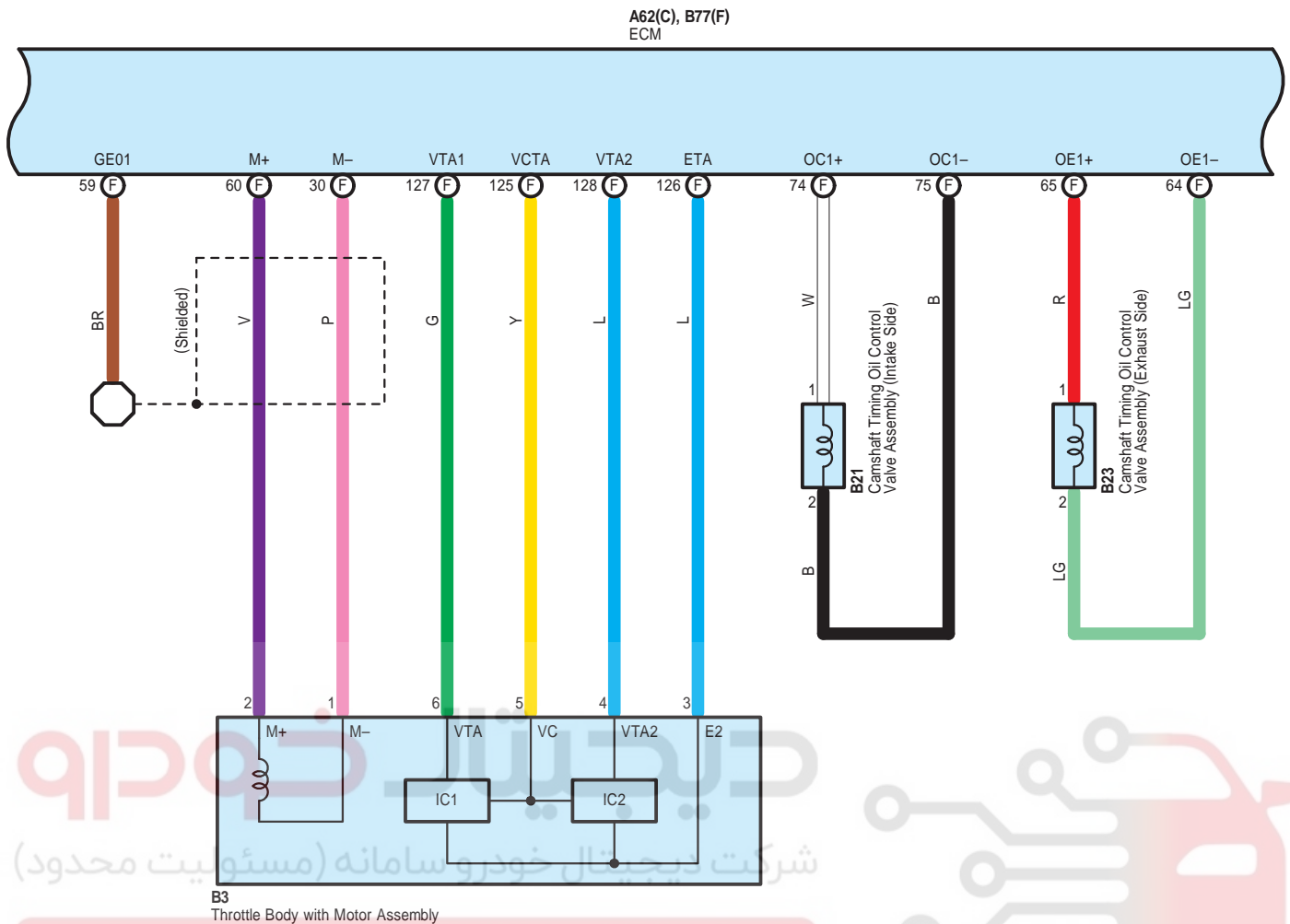

دیجیتال خودرو
شرکت دیجیتال خودرو سامانه (مسئولیت محدود)

اولین سامانه دیجیتال تعمیرکاران خودرو در ایران

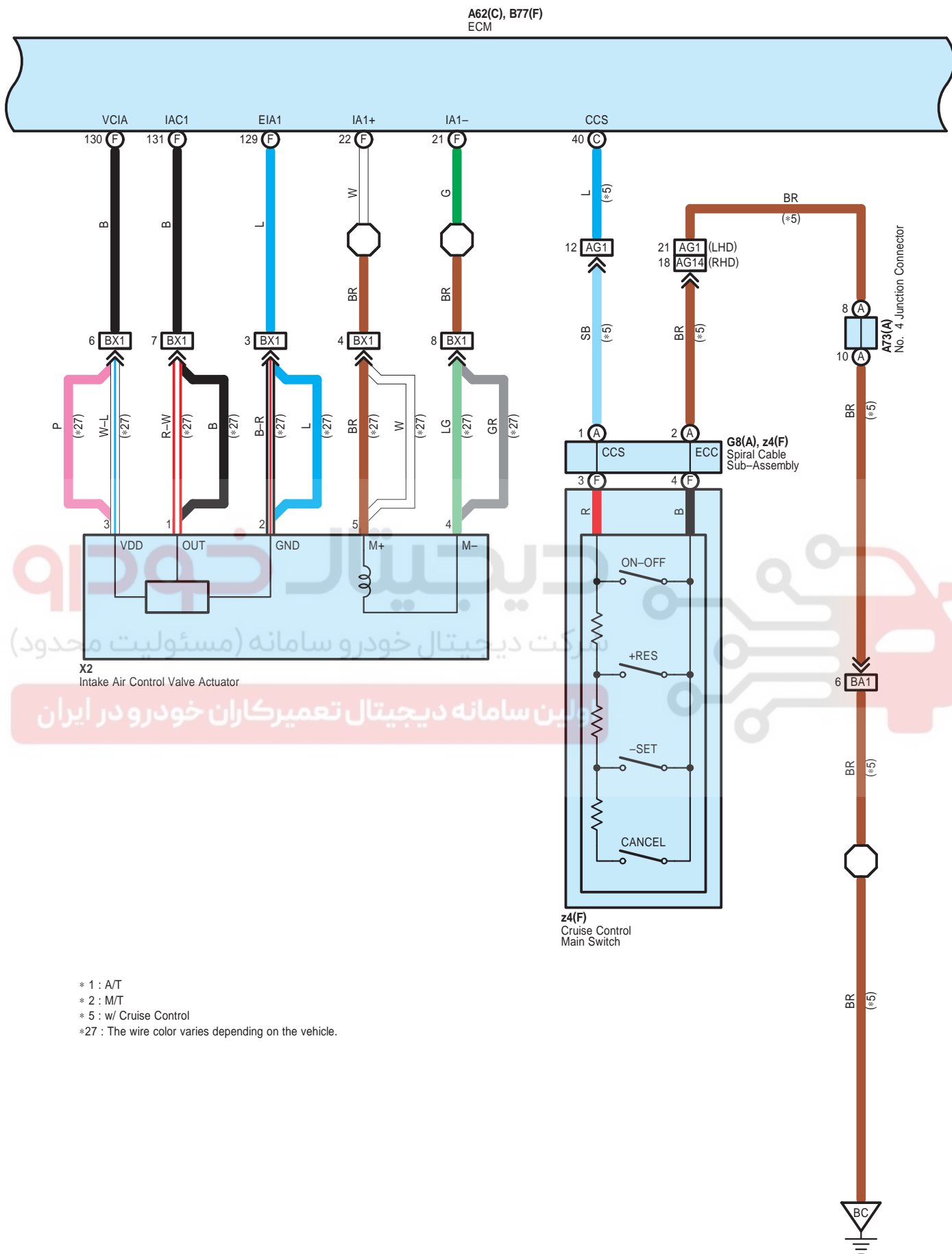

- * 1 : A/T
- * 2 : M/T
- * 5 : w/ Cruise Control
- *27 : The wire color varies depending on the vehicle.

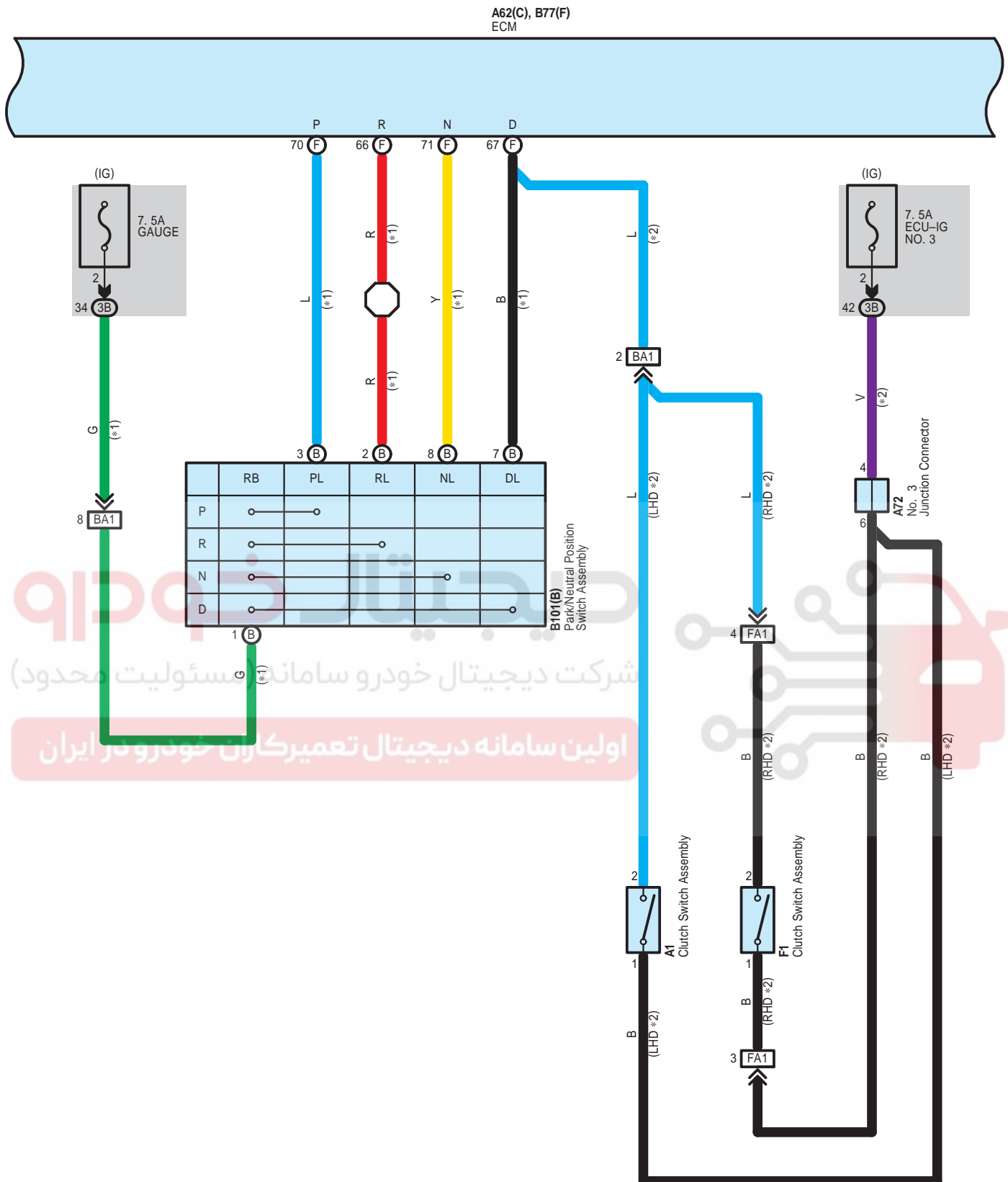

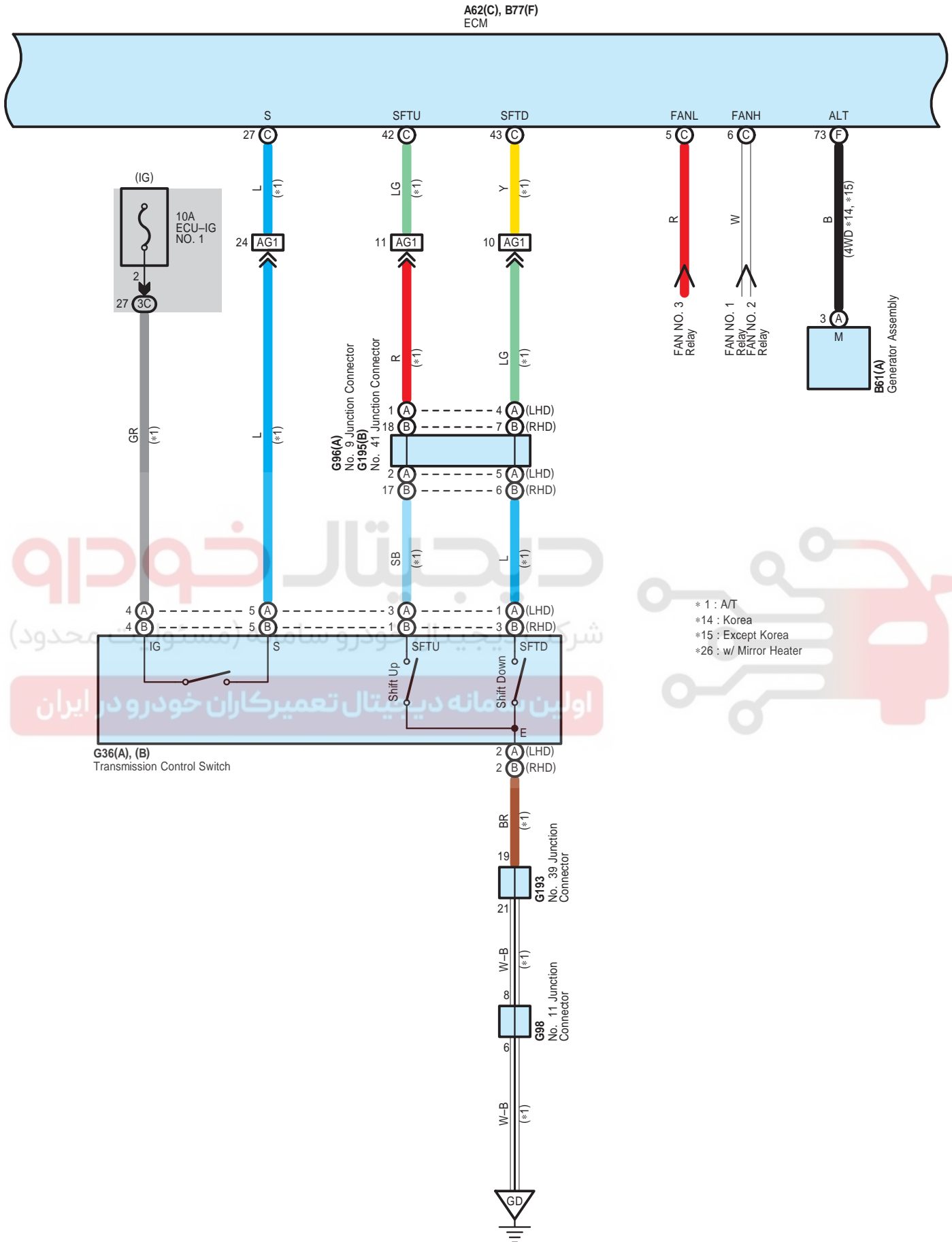

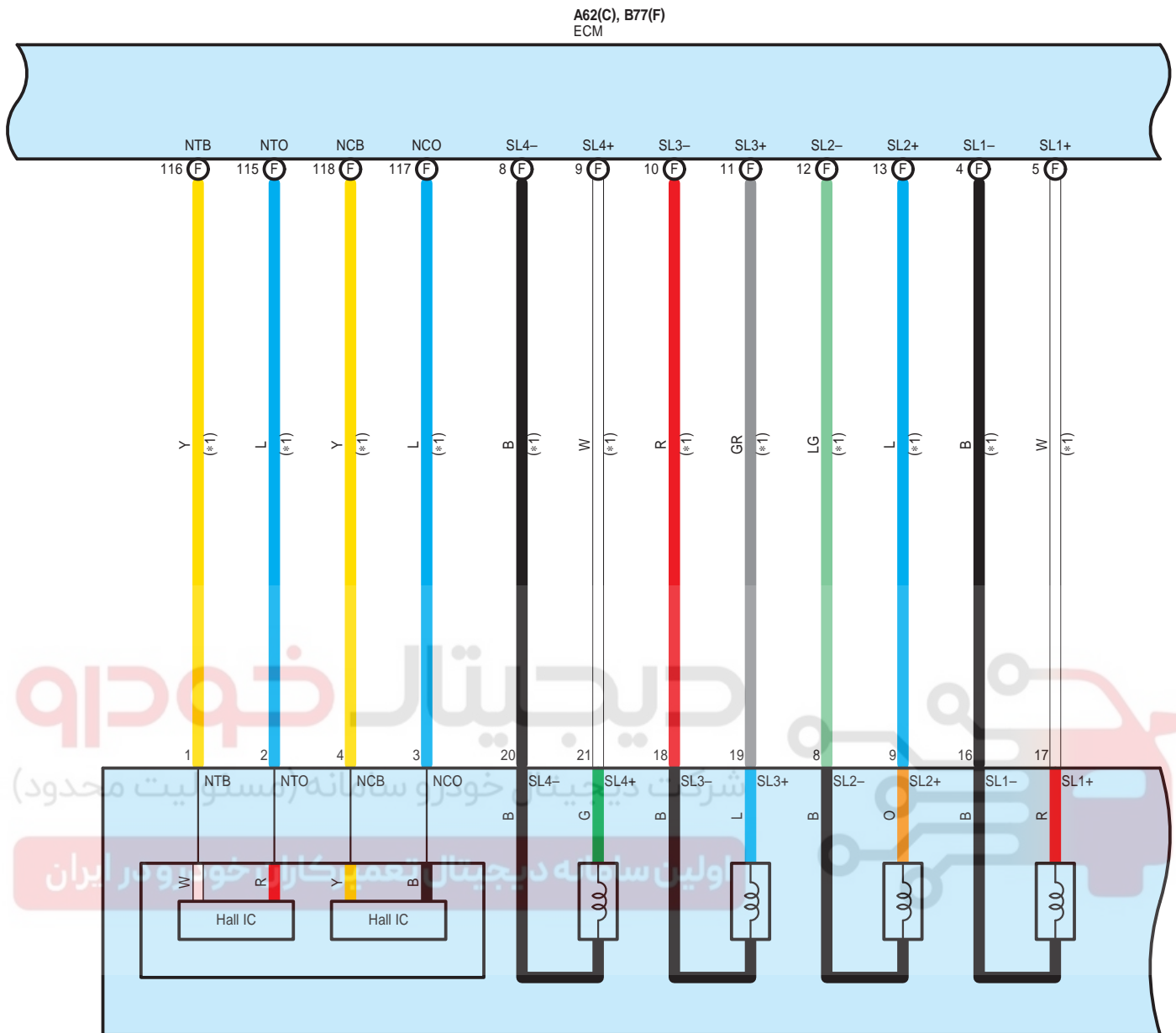

B78
ECT Solenoid (Transmission Wire)

* 1 : A/T
*14 : Korea
*22 : 2WD

Cruise Control (2AR-FE) (From Oct. 2015 Production), ECT and A/T Indicator (2AR-FE) (From Oct. 2015 Production), Engine Control (2AR-FE) (From Oct. 2015 Production)

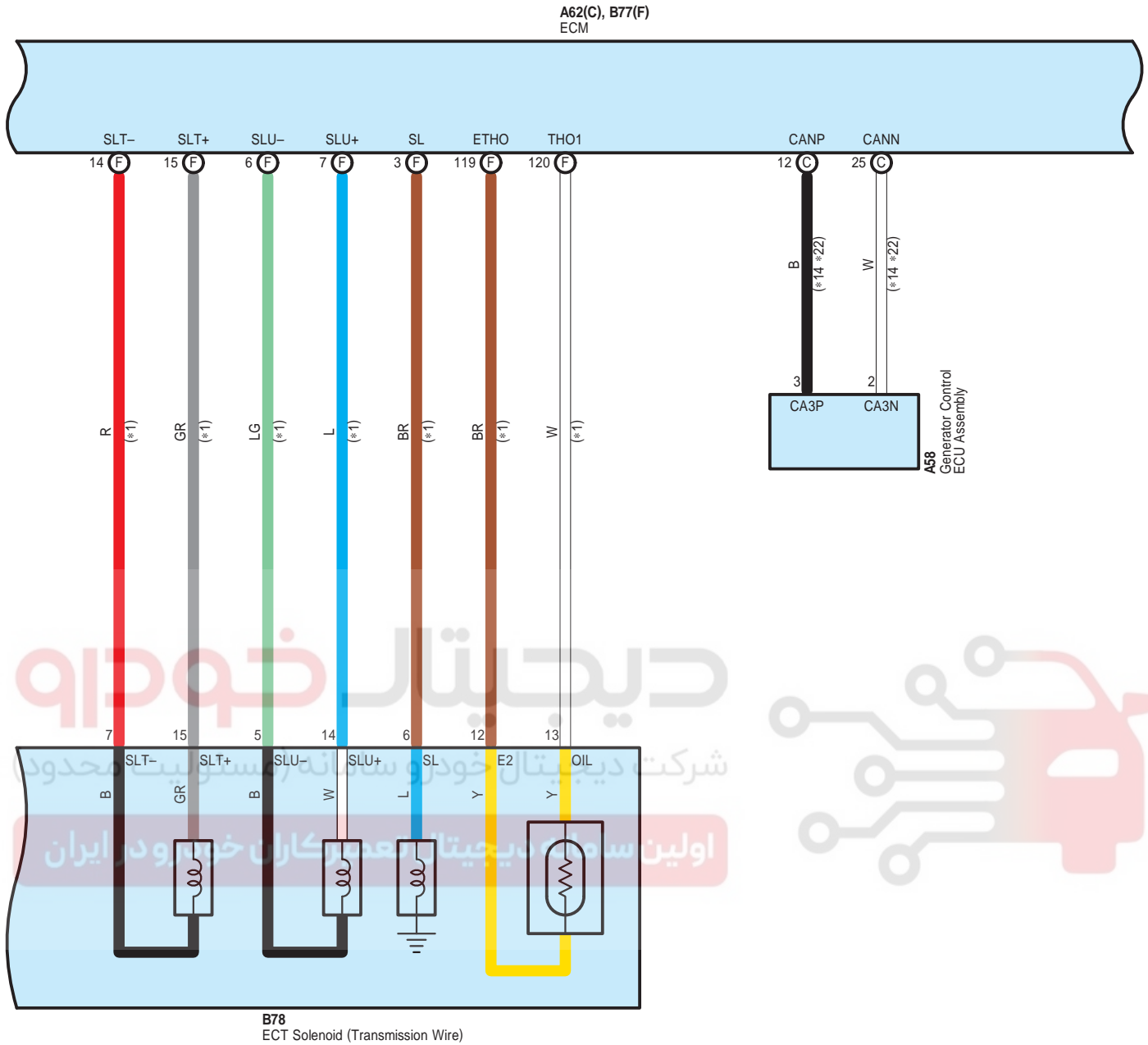

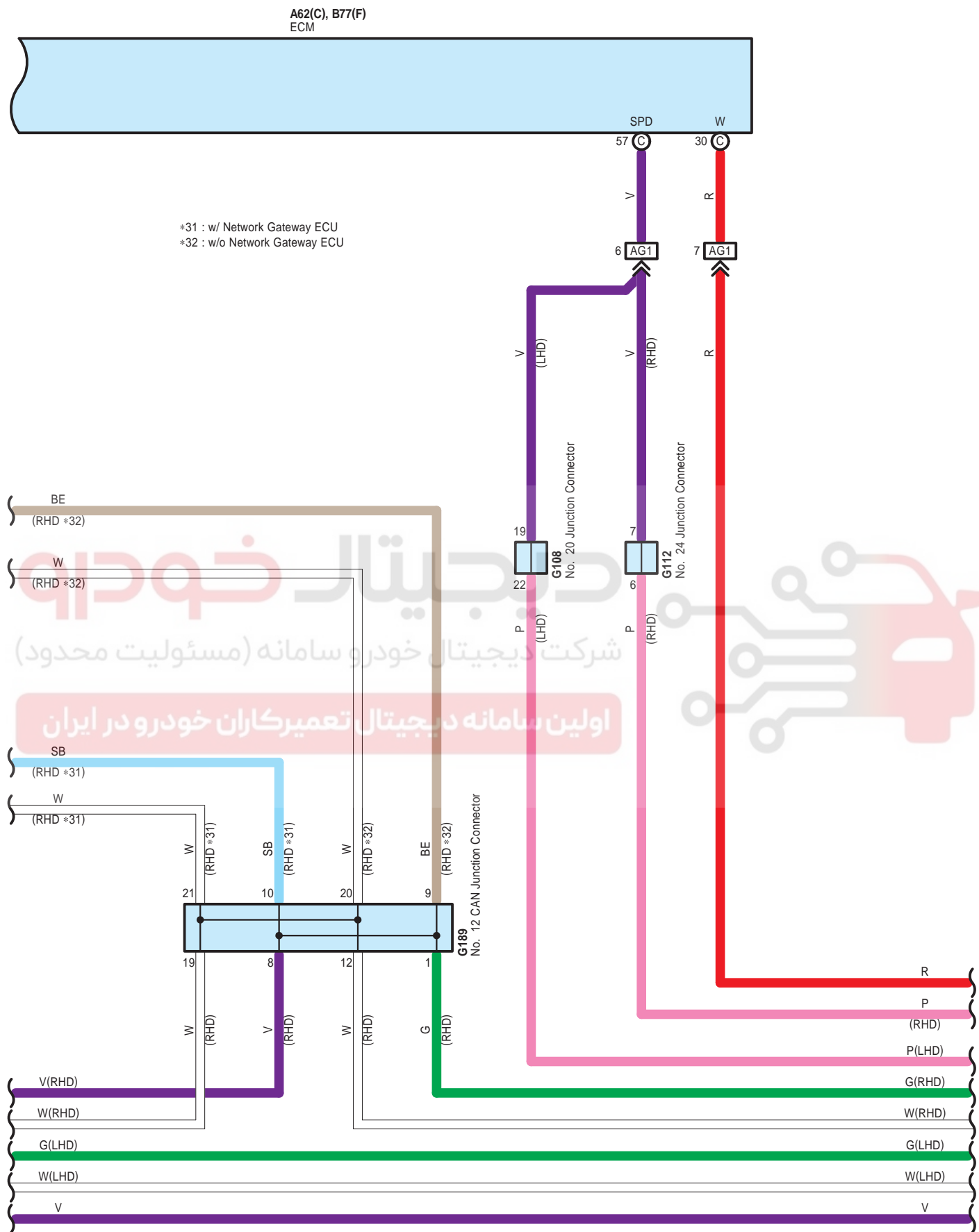

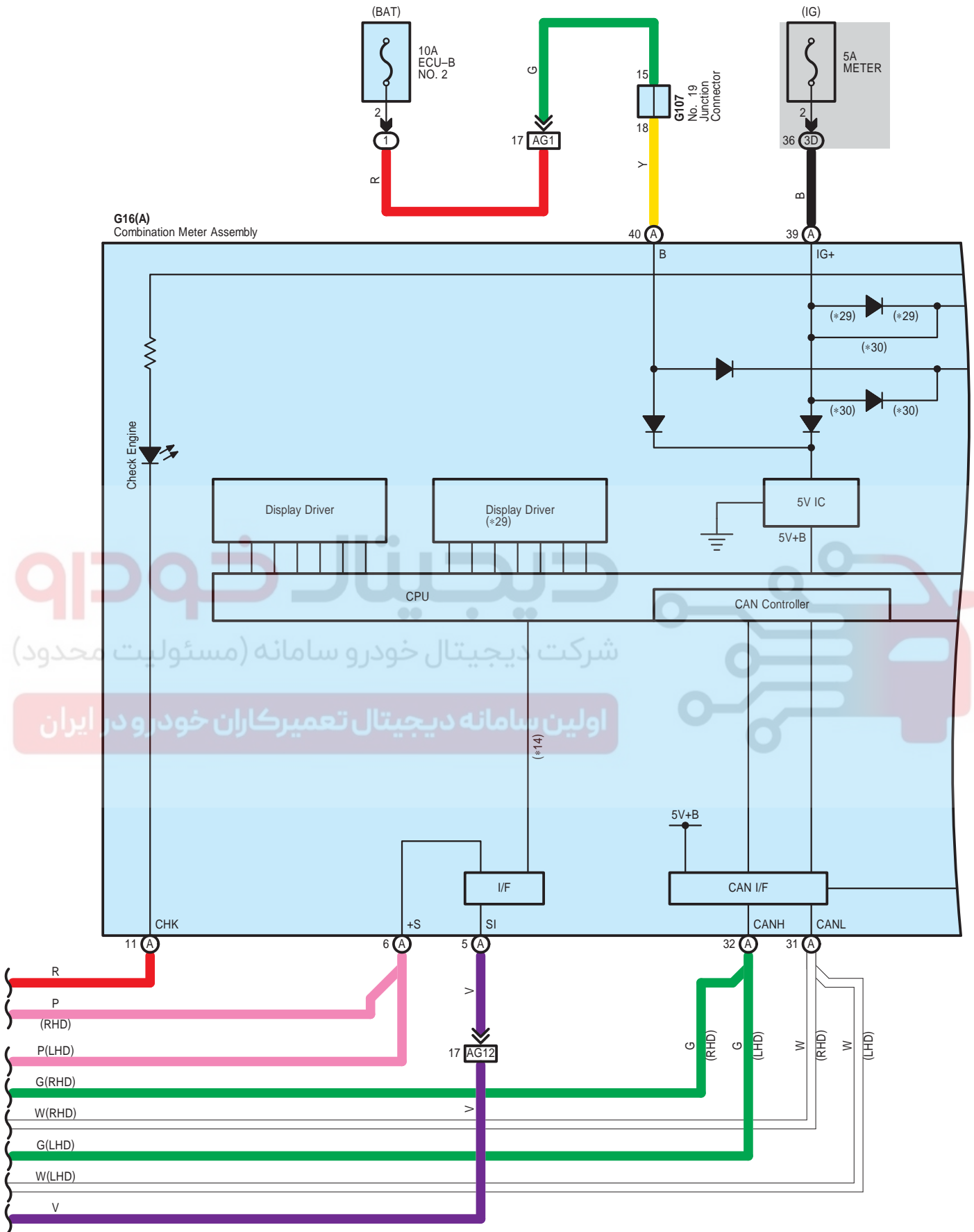

- *14 : Korea
- *15 : Except Korea
- *29 : TFT Display Type
- *30 : Segment Display Type

G16(A)
Combination Meter Assembly

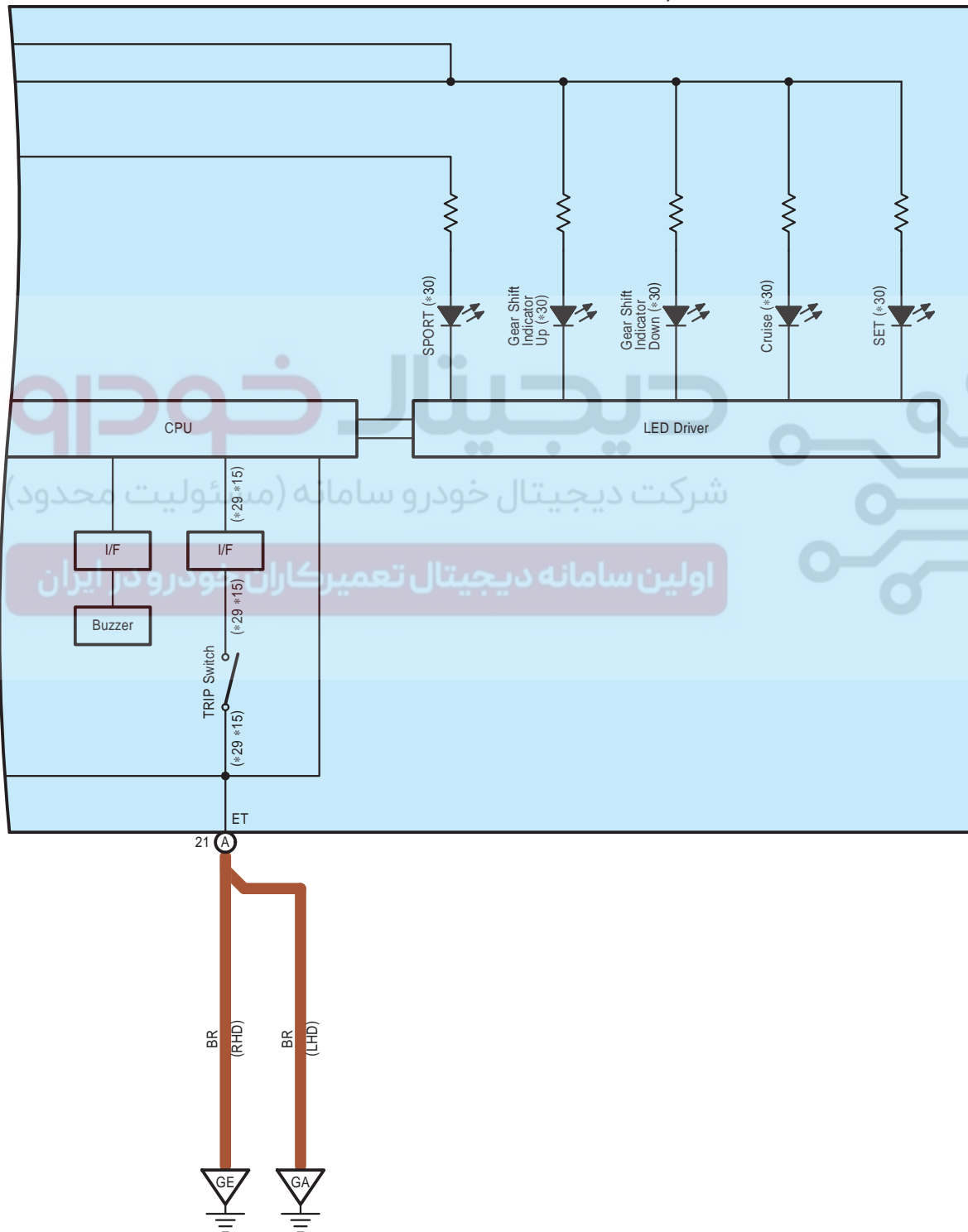

Cruise Control (2AR-FE) (From Oct. 2015 Production), ECT and A/T Indicator (2AR-FE) (From Oct. 2015 Production), Engine Control (2AR-FE) (From Oct. 2015 Production)

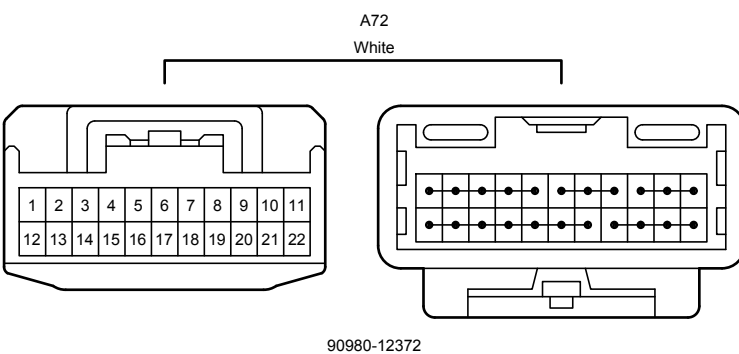
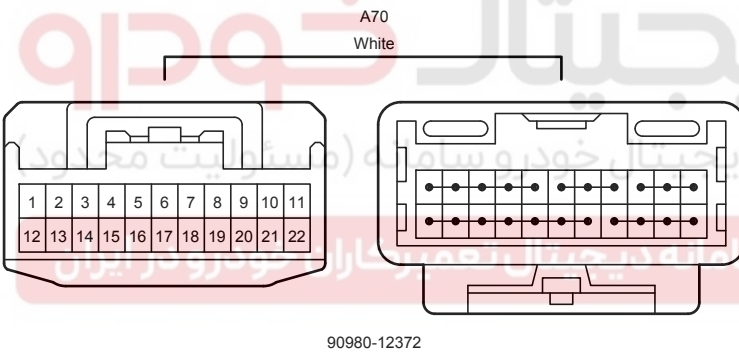
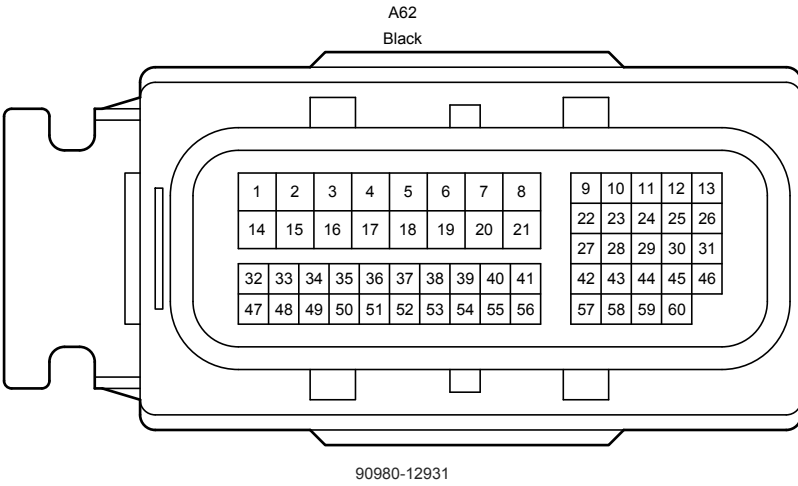
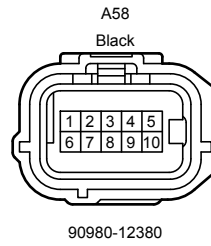
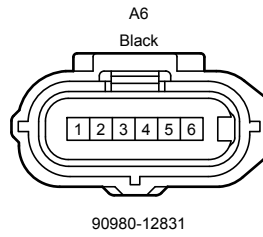
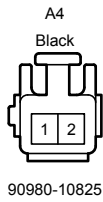
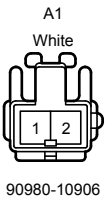

Cruise Control (2AR-FE) (From Oct. 2015 Production), ECT and A/T Indicator (2AR-FE) (From Oct. 2015 Production), Engine Control (2AR-FE) (From Oct. 2015 Production)

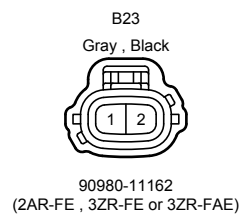
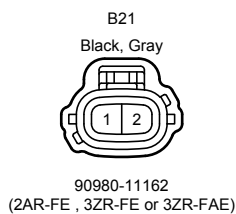
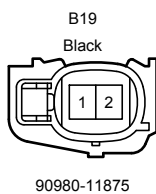
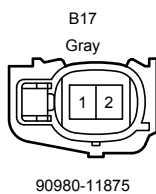
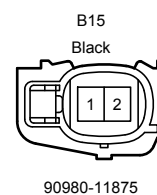
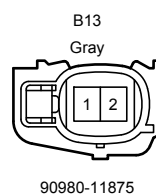
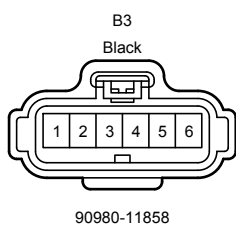
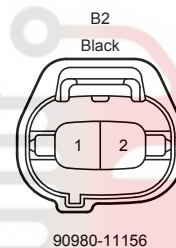
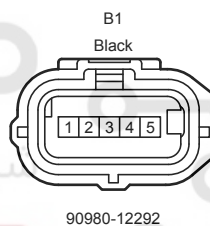
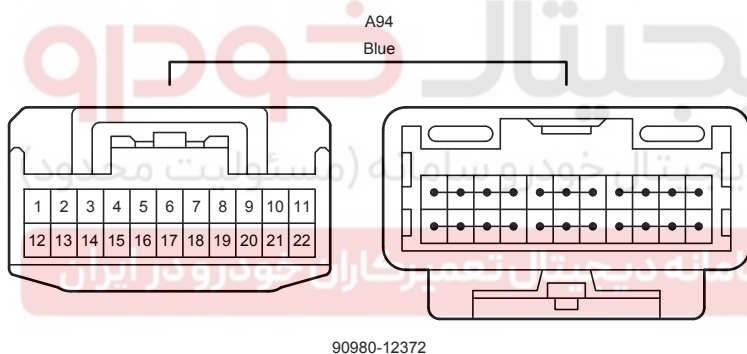
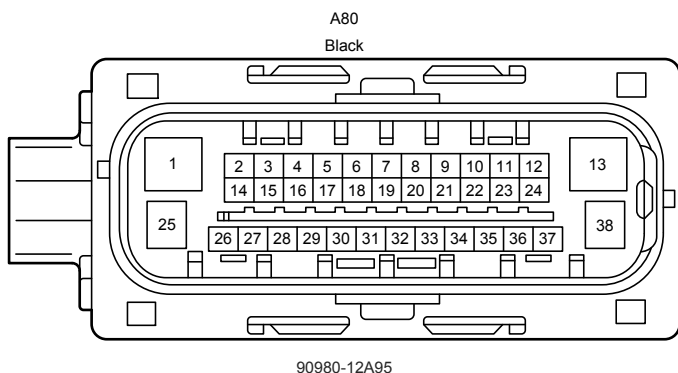
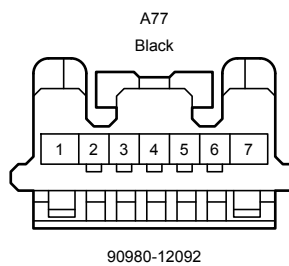
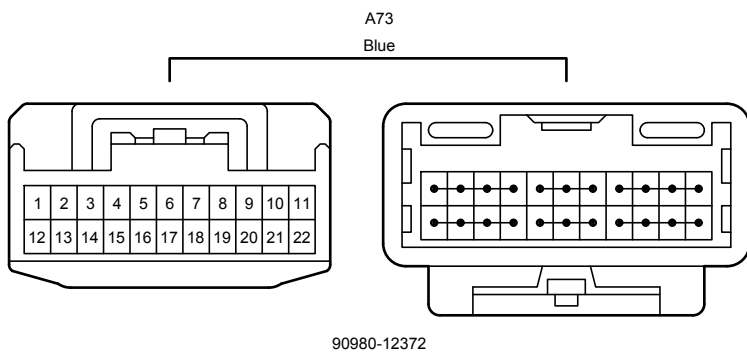

Cruise Control (2AR-FE) (From Oct. 2015 Production), ECT and A/T Indicator (2AR-FE) (From Oct. 2015 Production), Engine Control (2AR-FE) (From Oct. 2015 Production)

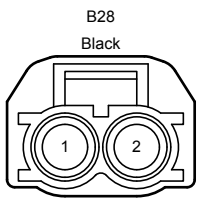

90980-12611

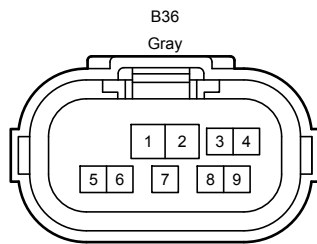

90980-12362

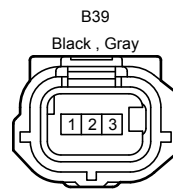

90980-12353
(2AR-FE, 3ZR-FE or 3ZR-FAE)

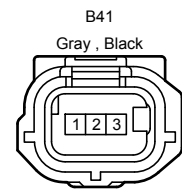

90980-12353
(2AR-FE, 3ZR-FE or 3ZR-FAE)

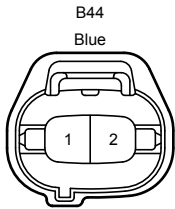

90980-11156

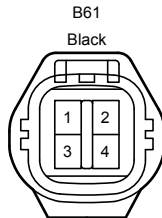

90980-11964

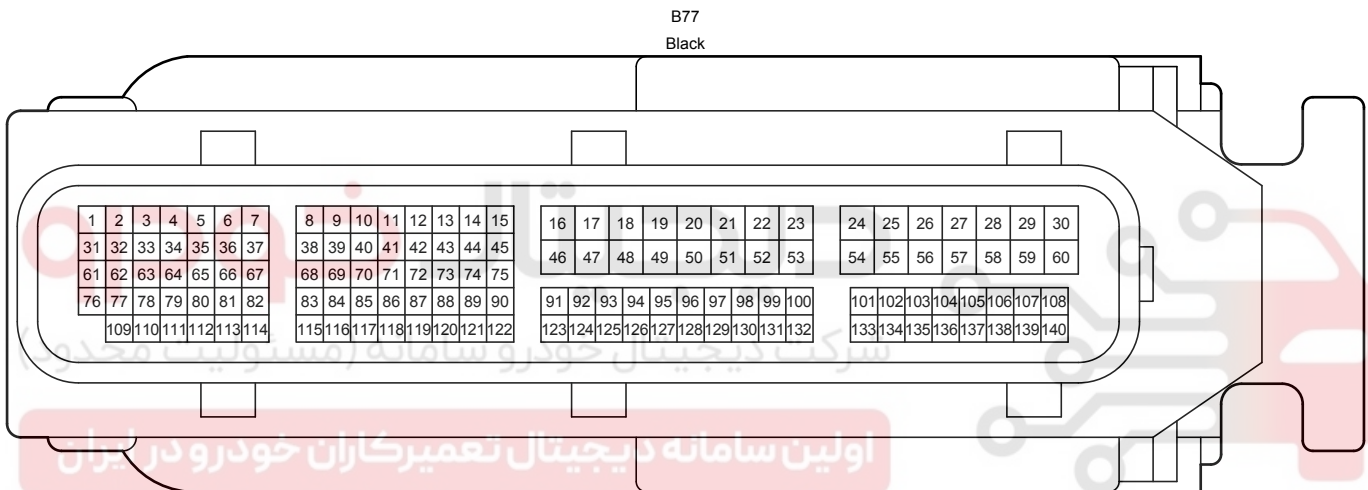

90980-12836

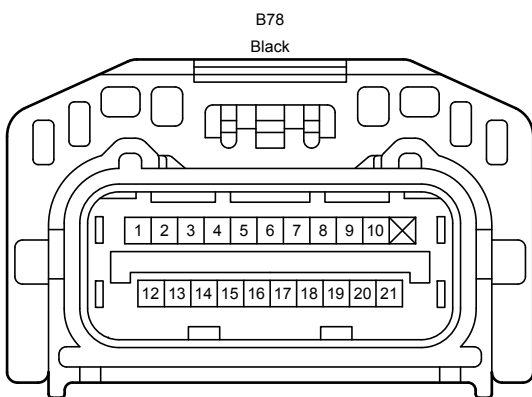

82824-33490

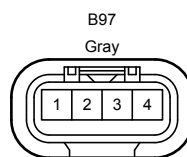

90980-12A29

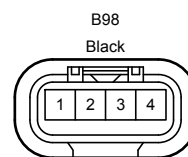

90980-12A29

Cruise Control (2AR-FE) (From Oct. 2015 Production), ECT and A/T Indicator (2AR-FE) (From Oct. 2015 Production), Engine Control (2AR-FE) (From Oct. 2015 Production)

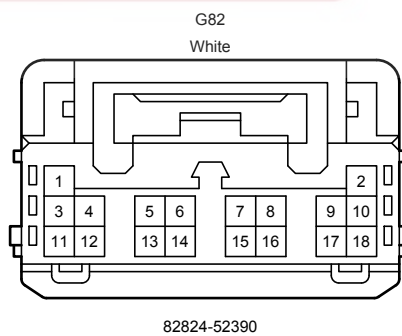
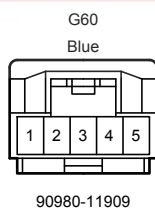
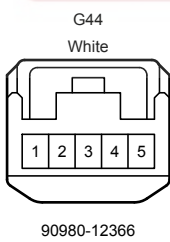
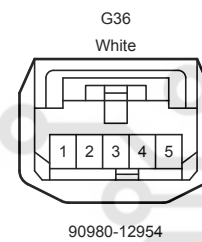
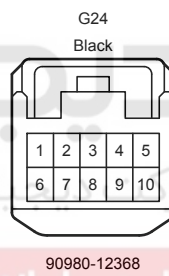
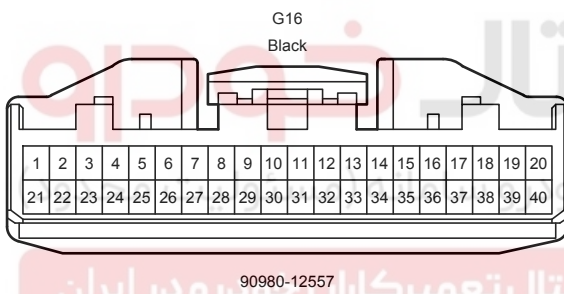
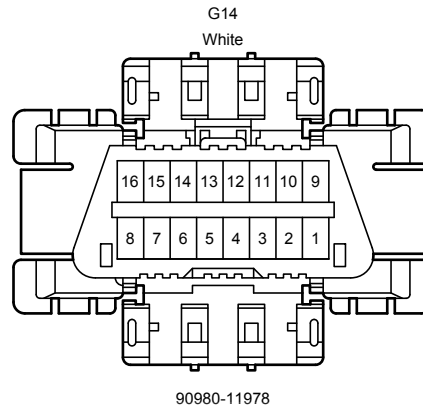
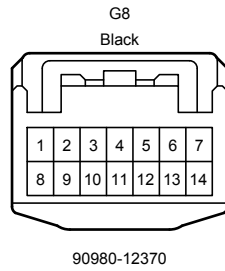
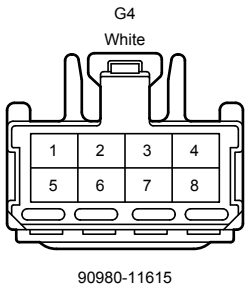
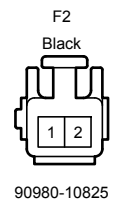
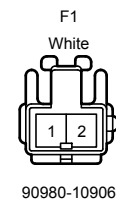
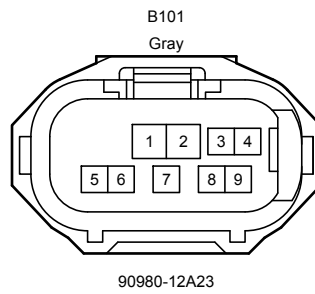
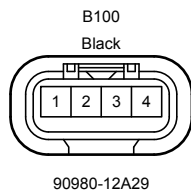
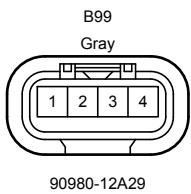

اولین سامانه دیجیتال تعمیرکاران خودرو در ایران

Cruise Control (2AR-FE) (From Oct. 2015 Production), ECT and A/T Indicator (2AR-FE) (From Oct. 2015 Production), Engine Control (2AR-FE) (From Oct. 2015 Production)

G84
Black

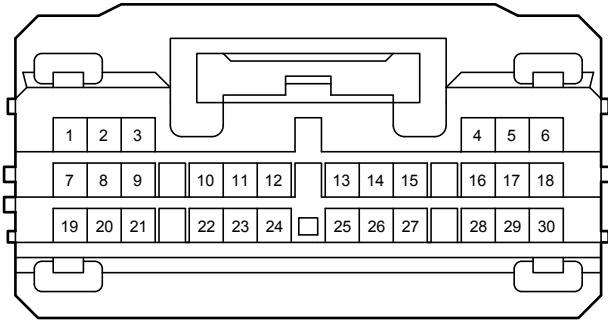

82824-52370

G88
Black

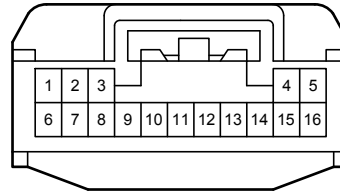

90980-12423

G96
White

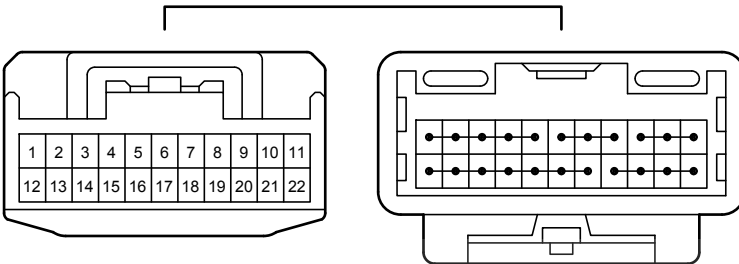

90980-12372

G98
Gray

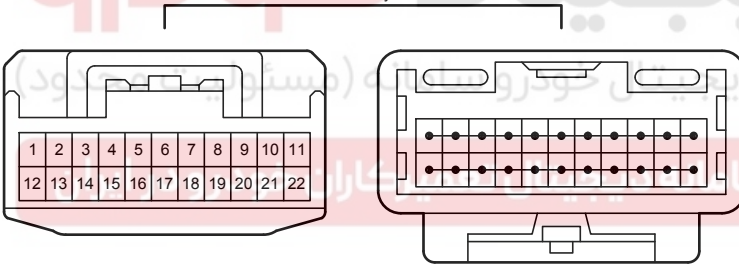

90980-12372

G99
White

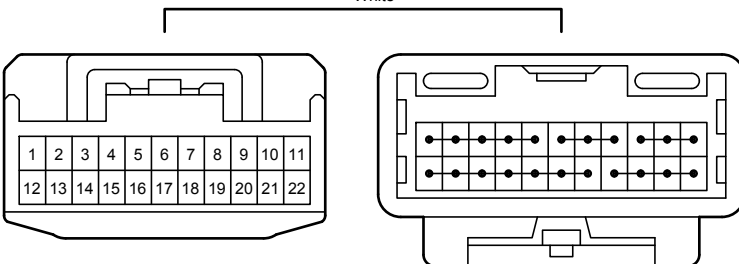

90980-12372



Cruise Control (2AR-FE) (From Oct. 2015 Production), ECT and A/T Indicator (2AR-FE) (From Oct. 2015 Production), Engine Control (2AR-FE) (From Oct. 2015 Production)

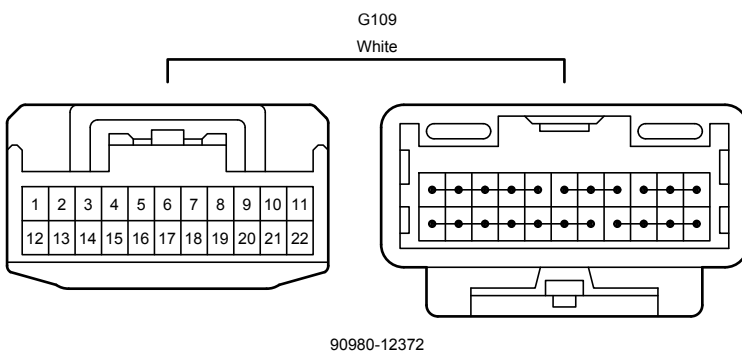
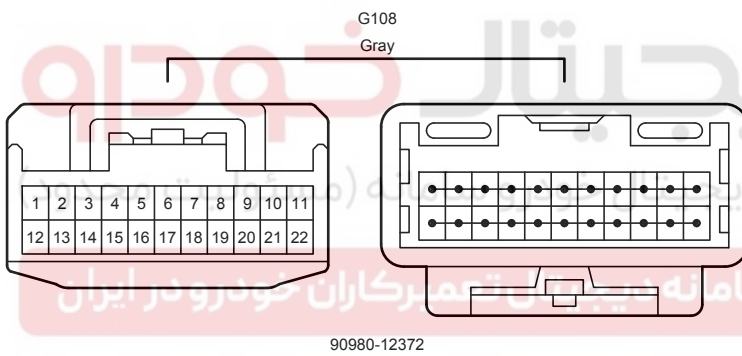
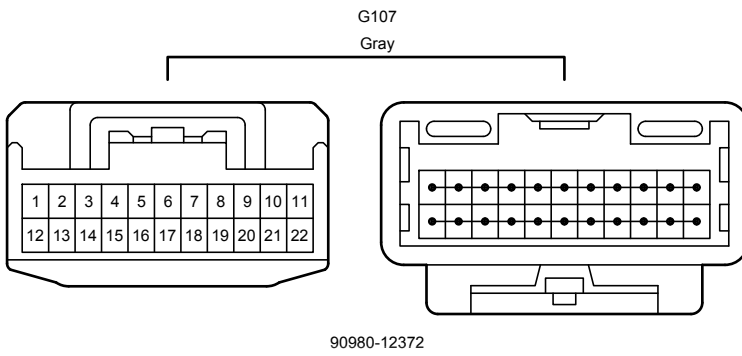
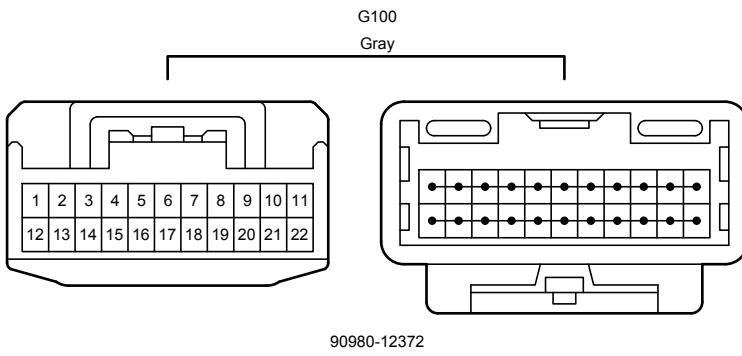

Cruise Control (2AR-FE) (From Oct. 2015 Production), ECT and A/T Indicator (2AR-FE) (From Oct. 2015 Production), Engine Control (2AR-FE) (From Oct. 2015 Production)

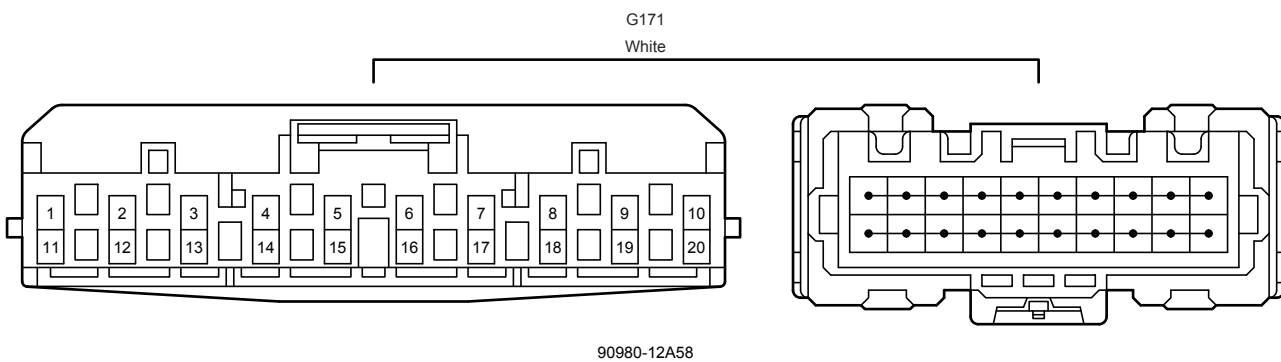
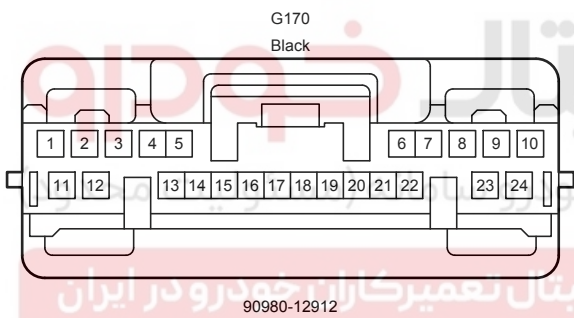
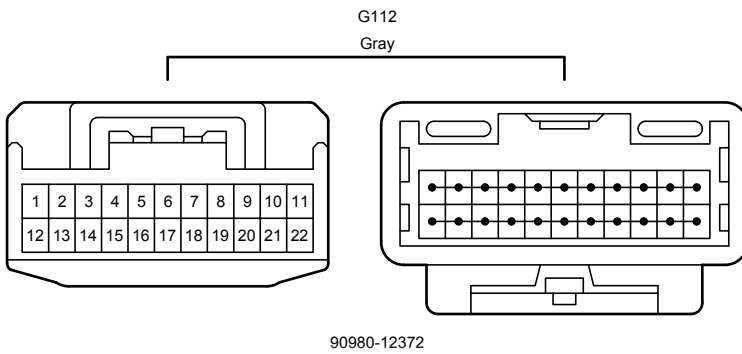
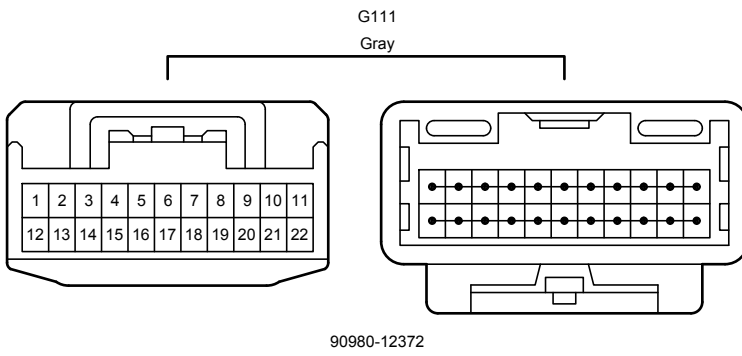

Cruise Control (2AR-FE) (From Oct. 2015 Production), ECT and A/T Indicator (2AR-FE) (From Oct. 2015 Production), Engine Control (2AR-FE) (From Oct. 2015 Production)

G172
White

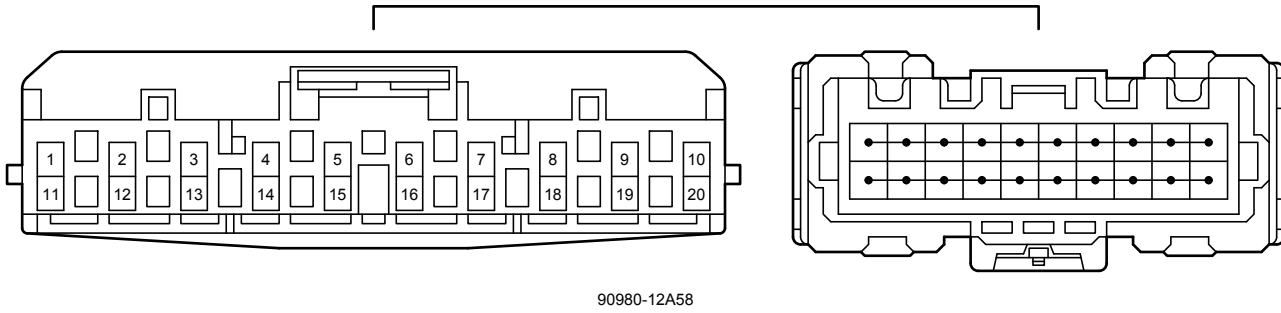

G188
Gray

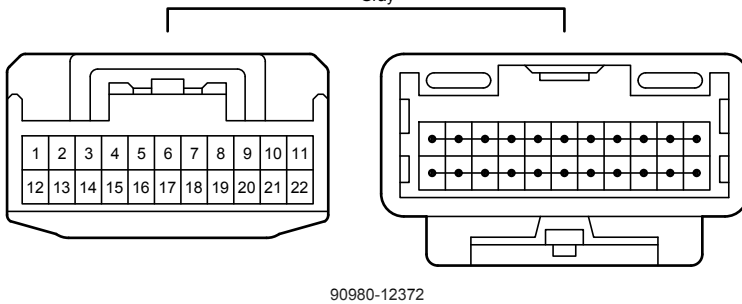

G189
Gray

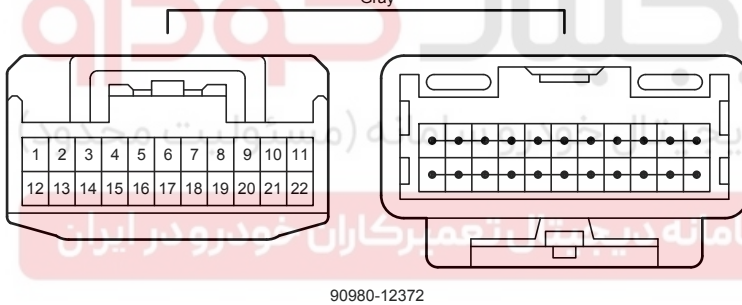

G192
Blue

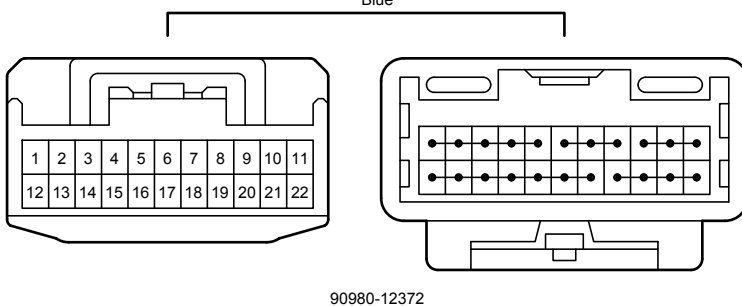

Cruise Control (2AR-FE) (From Oct. 2015 Production), ECT and A/T Indicator (2AR-FE) (From Oct. 2015 Production), Engine Control (2AR-FE) (From Oct. 2015 Production)

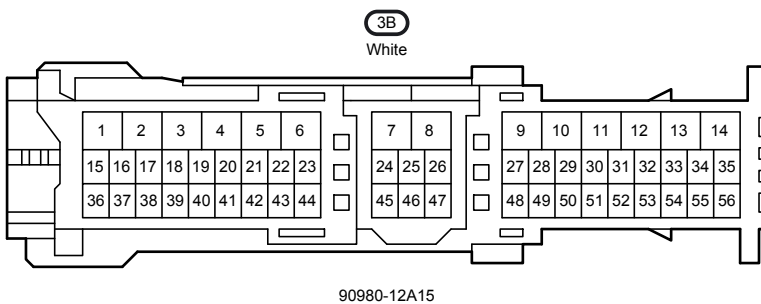
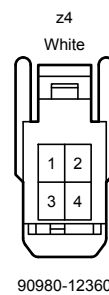
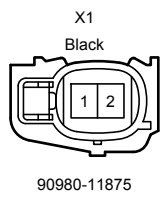
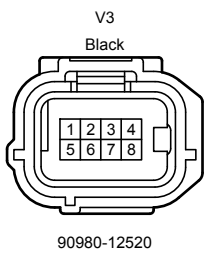
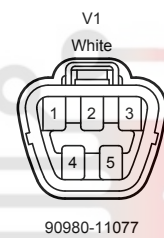
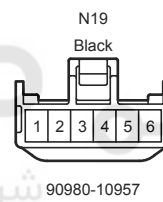
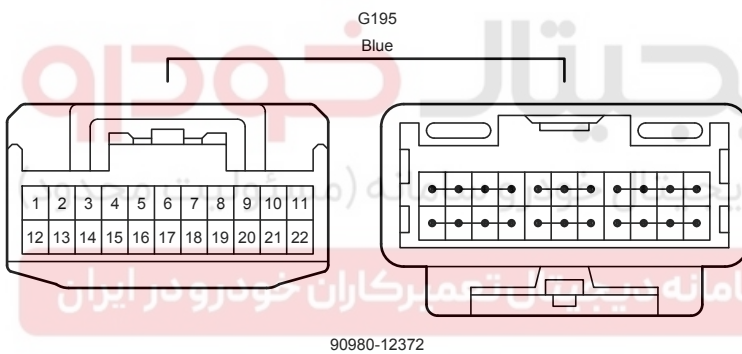
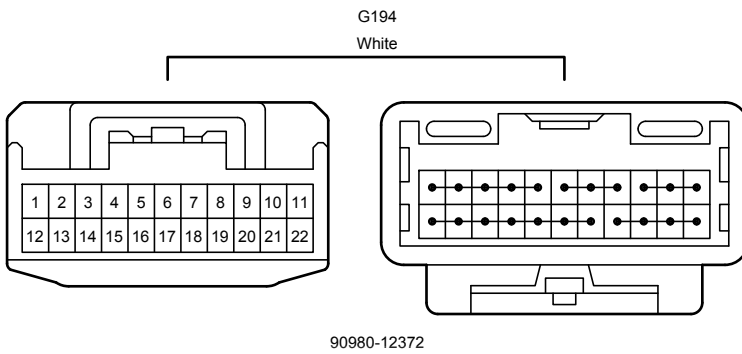
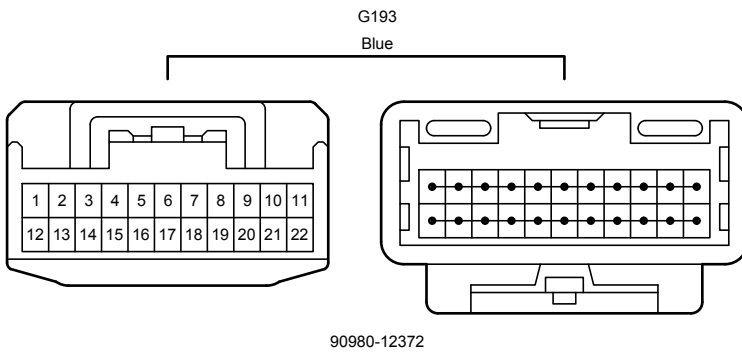

3C

White

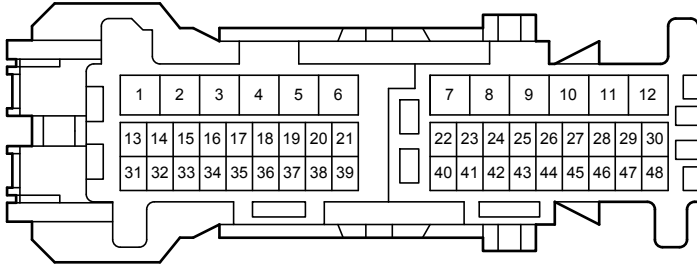

90980-12887

3D

White

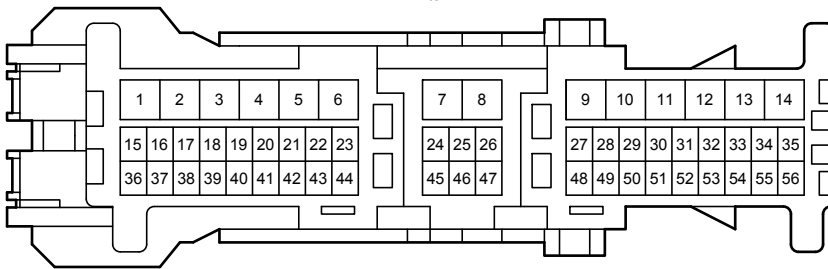

90980-12890

AG1

Blue

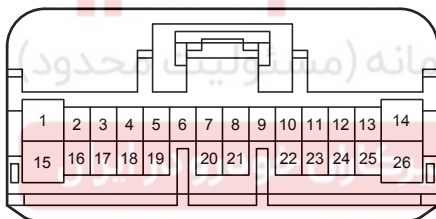

90980-12771

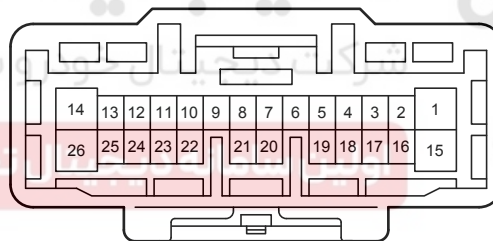

90980-12770

AG5

White

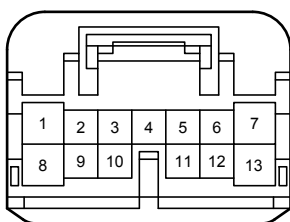

90980-12767

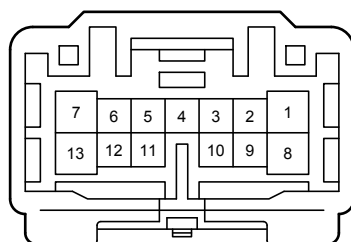

90980-12766

Cruise Control (2AR-FE) (From Oct. 2015 Production), ECT and A/T Indicator (2AR-FE) (From Oct. 2015 Production), Engine Control (2AR-FE) (From Oct. 2015 Production)

AG11

Black

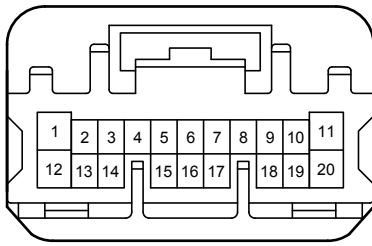

90980-12741

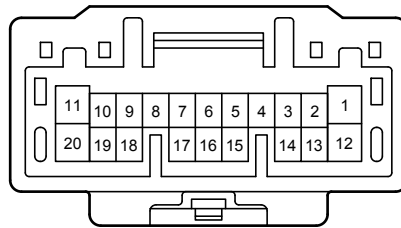

90980-12740

AG12

Blue

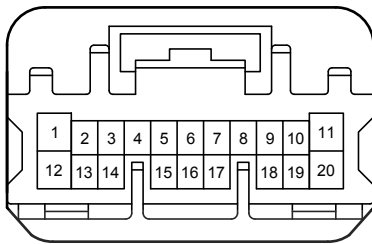

90980-12741

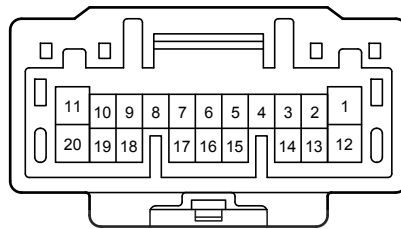

90980-12740

AG14

Gray

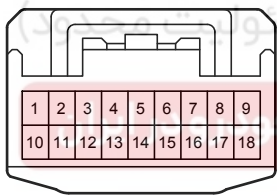

90980-12412

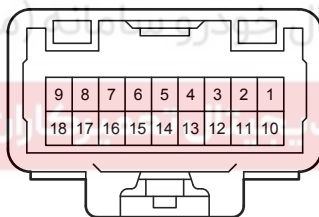

90980-12411

AN2

White

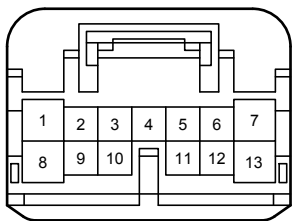

90980-12767

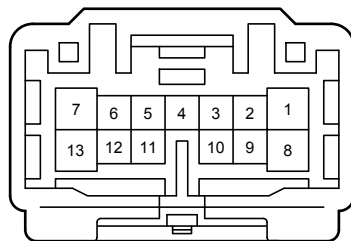

90980-12766

BA1

Blue

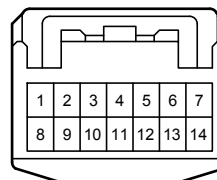

90980-12370

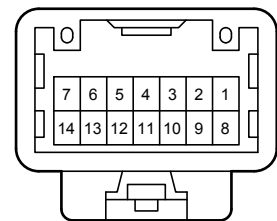

90980-12369

Cruise Control (2AR-FE) (From Oct. 2015 Production), ECT and A/T Indicator (2AR-FE) (From Oct. 2015 Production), Engine Control (2AR-FE) (From Oct. 2015 Production)

